



Micro Commercial Components



Micro Commercial Components
 20736 Marilla Street Chatsworth
 CA 91311
 Phone: (818) 701-4933
 Fax: (818) 701-4939

FR10A THRU FR10M

Features

- Lead Free Finish/Rohs Compliant (Note1) ("P" Suffix designates Compliant. See ordering information)
- Epoxy meets UL 94 V-0 flammability rating
- Moisture Sensitivity Level 1
- Marking : Cathode band and type number
- Fast Switching Speed For High Efficiency

Maximum Ratings

- Operating Temperature: -55°C to +150°C
- Storage Temperature: -55°C to +150°C

MCC Part Number	Maximum Recurrent Peak Reverse Voltage	Maximum RMS Voltage	Maximum DC Blocking Voltage
FR10A	50V	35V	50V
FR10B	100V	70V	100V
FR10D	200V	140V	200V
FR10G	400V	280V	400V
FR10J	600V	420V	600V
FR10K	800V	560V	800V
FR10M	1000V	700V	1000V

10 Amp Fast Recovery Rectifier 50 to 1000 Volts

DO-214AB (HSMC) (Round Lead)

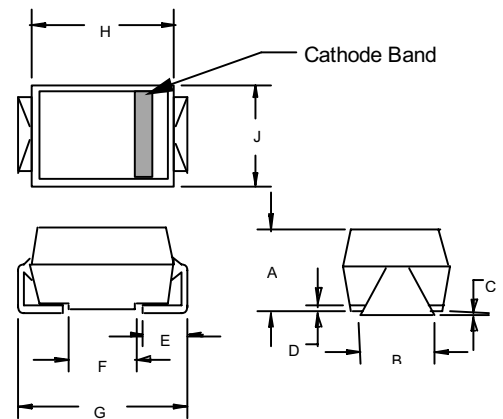

DIM	DIMENSIONS				NOTE
	INCHES		MM		
A	.200	.214	5.08	5.43	
B	.177	.203	4.70	5.30	
C	.002	.005	.05	.13	
D	—	.02	—	.51	
E	.047	.056	1.20	1.42	
F	.168	.179	4.27	4.55	
G	.309	.322	7.85	8.18	
H	.239	.243	6.08	6.18	
J	.234	.240	5.95	6.10	

SUGGESTED SOLDER PAD LAYOUT

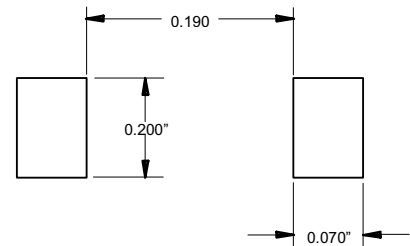

Electrical Characteristics @ 25°C Unless Otherwise Specified

Average Forward Current	$I_{F(AV)}$	10 A	$T_A = 55^\circ\text{C}$
Peak Forward Surge Current	I_{FSM}	300A	8.3ms, half sine
Maximum Instantaneous Forward Voltage	V_F	1.30V	$I_{FM} = 10.0\text{A};$ $T_A = 25^\circ\text{C}$
Maximum DC Reverse Current At Rated DC Blocking Voltage	I_R	10 μA 50 μA	$T_A = 25^\circ\text{C}$ $T_A = 100^\circ\text{C}$
Maximum Reverse Recovery Time	T_{rr}	150ns 250ns 500ns	$I_F=0.5\text{A}, I_R=1.0\text{A},$ $I_{rr}=0.25\text{A}$
			FR10A-FR10G FR10J FR10K-FR10M

*Pulse Test: Pulse Width 300 μsec , Duty Cycle 1%

Note: 1. High Temperature Solder Exemptions Applied, see EU Directive Annex 7.

FR10A thru FR10M

Figure 1
Typical Forward Characteristics

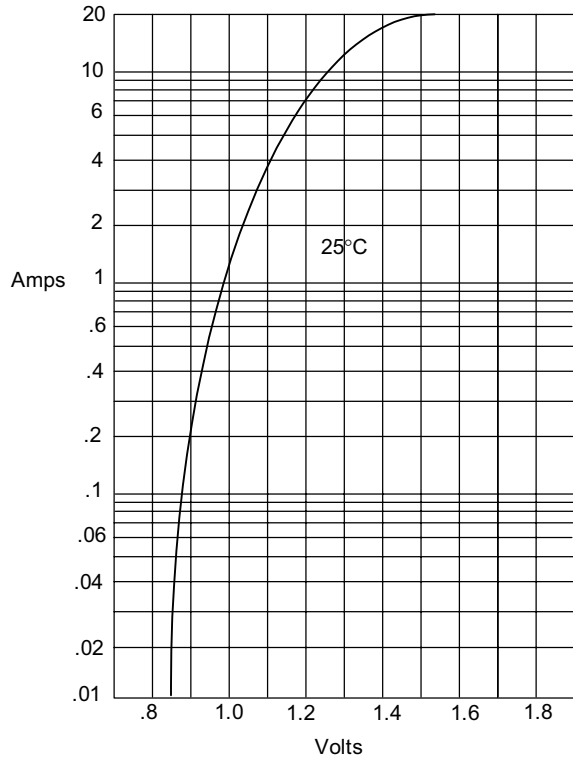

Instantaneous Forward Current - Amperes versus
Instantaneous Forward Voltage - Volts

Figure 2
Forward Derating Curve

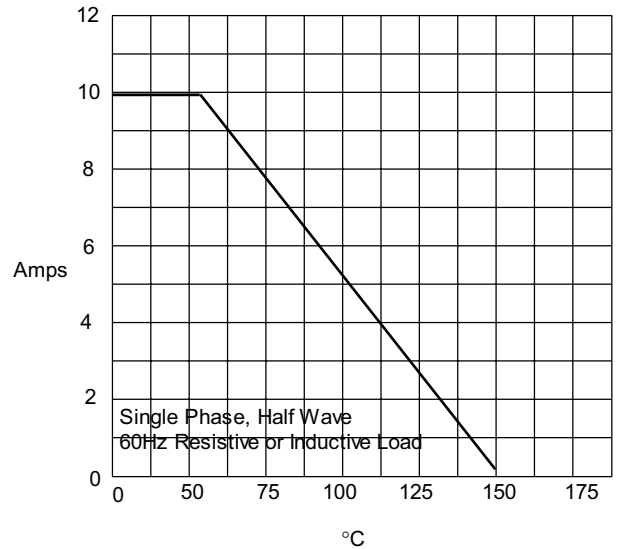
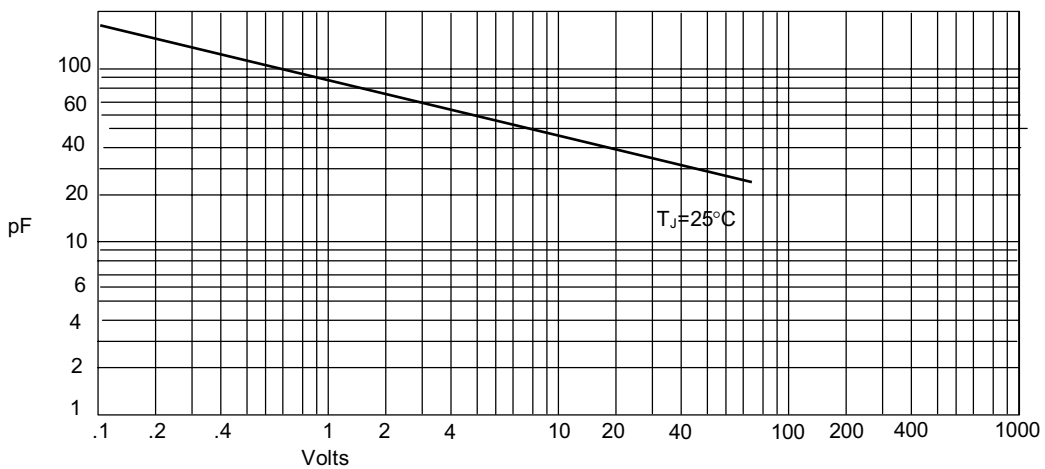

Figure 3
Junction Capacitance



Junction Capacitance - pF versus
Reverse Voltage - Volts

FR10A thru FR10M

Figure 4
Peak Forward Surge Current

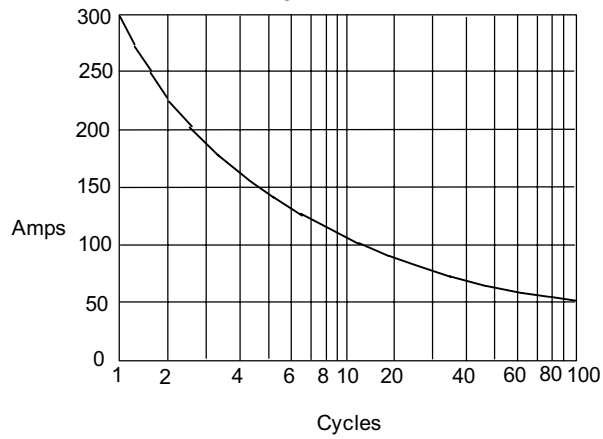

Peak Forward Surge Current - Amperes versus
Number Of Cycles At 60Hz - Cycles

Figure 5
Reverse Recovery Time Characteristic And Test Circuit Diagram

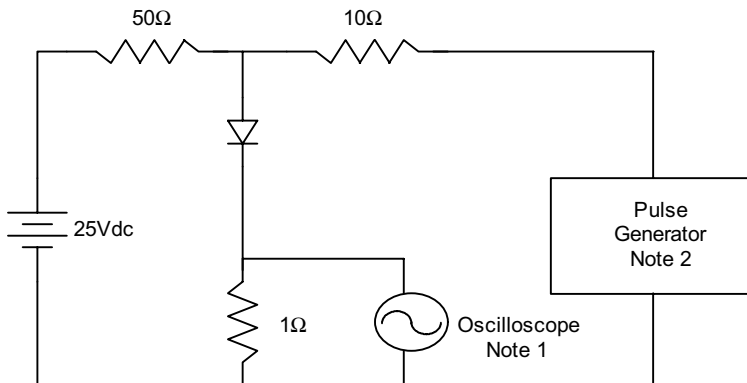

- Notes:
1. Rise Time = 7ns max.
Input impedance = 1 megohm, 22pF
 2. Rise Time = 10ns max.
Source impedance = 50 ohms
 3. Resistors are non-inductive

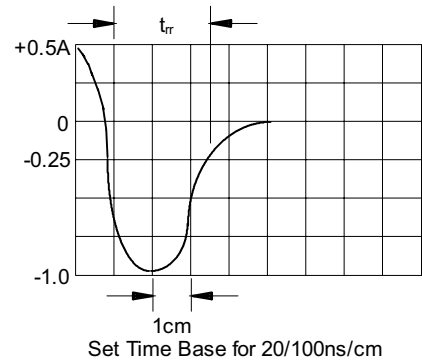



Micro Commercial Components

Ordering Information :

Device	Packing
Part Number-TP	Tape&Reel: 1.5Kpcs/Reel

*****IMPORTANT NOTICE*****

Micro Commercial Components Corp. reserves the right to make changes without further notice to any product herein to make corrections, modifications , enhancements , improvements , or other changes . **Micro Commercial Components Corp .** does not assume any liability arising out of the application or use of any product described herein; neither does it convey any license under its patent rights ,nor the rights of others . The user of products in such applications shall assume all risks of such use and will agree to hold **Micro Commercial Components Corp .** and all the companies whose products are represented on our website, harmless against all damages.

*****LIFE SUPPORT*****

MCC's products are not authorized for use as critical components in life support devices or systems without the express written approval of Micro Commercial Components Corporation.

*****CUSTOMER AWARENESS*****

Counterfeiting of semiconductor parts is a growing problem in the industry. Micro Commercial Components (MCC) is taking strong measures to protect ourselves and our customers from the proliferation of counterfeit parts. MCC strongly encourages customers to purchase MCC parts either directly from MCC or from Authorized MCC Distributors who are listed by country on our web page cited below. Products customers buy either from MCC directly or from Authorized MCC Distributors are genuine parts, have full traceability, meet MCC's quality standards for handling and storage. **MCC will not provide any warranty coverage or other assistance for parts bought from Unauthorized Sources.** MCC is committed to combat this global problem and encourage our customers to do their part in stopping this practice by buying direct or from authorized distributors.