



Micro Commercial Components

Micro Commercial Components
20736 Marilla Street Chatsworth
CA 91311
Phone: (818) 701-4933
Fax: (818) 701-4939

**EGP10A
THRU
EGP10K**

**1.0 Amp Glass
Passivated High
Efficient Rectifiers
50 to 800 Volts**

Features

- Glass passivated cavity-free junction.
- Case Material: Molded Plastic. UL Flammability Classification Rating 94V-0 and MSL rating 1
- Marking : Cathode band and type number
- Lead Free Finish/RoHS Compliant (Note1) ("P" Suffix designates Compliant. See ordering information)

Maximum Ratings

- Operating Temperature: -55°C to +150°C
- Storage Temperature: -55°C to +150°C
- Typical Thermal Resistance: 50°C/W Junction to Ambient

MCC Part Number	Maximum Recurrent Peak Reverse Voltage	Maximum RMS Voltage	Maximum DC Blocking Voltage
EGP10A	50V	35V	50V
EGP10B	100V	70V	100V
EGP10D	200V	140V	200V
EGP10F	300V	210V	300V
EGP10G	400V	280V	400V
EGP10J	600V	420V	600V
EGP10K	800V	560V	800V

Electrical Characteristics @ 25°C Unless Otherwise Specified

Average Forward Current	$I_{F(AV)}$	1.0 A	$T_A = 55^\circ\text{C}$
Peak Forward Surge Current	I_{FSM}	30A	8.3ms, half sine
Maximum Instantaneous Forward Voltage	V_F	EGP10A-10D: 1.00V EGP10F-10G: 1.25V EGP10J-10K: 1.70V	$I_F=1.0A$ $T_A=25^\circ\text{C}$
Maximum DC Reverse Current At Rated DC Blocking Voltage	I_R	5.0uA 100uA	$T_A = 25^\circ\text{C}$ $T_A = 125^\circ\text{C}$
Maximum Reverse Recovery Time	t_{rr}	EGP10A-10G: 50nS EGP10J-10K: 75nS	$I_F=0.5A$, $I_R=1.0A$, $I_{RR}=0.25A$ $T_J=25^\circ\text{C}$
Typical Junction Capacitance	C_J	EGP10A-10D: 22pF EGP10F-10K: 15pF	Measured at 1.0MHz, $V_R=4.0V$

DO-41

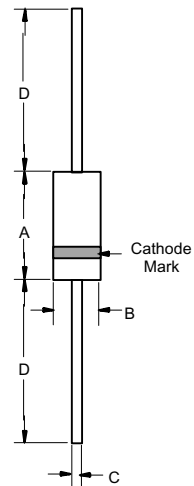

DIM	INCHES		MM		NOTE
	MIN	MAX	MIN	MAX	
A	.166	.205	4.10	5.20	
B	.080	.107	2.00	2.70	
C	.028	.034	.70	.90	
D	1.000	---	25.40	---	

EGP10A thru EGP10K

Figure 1
Typical Forward Characteristics

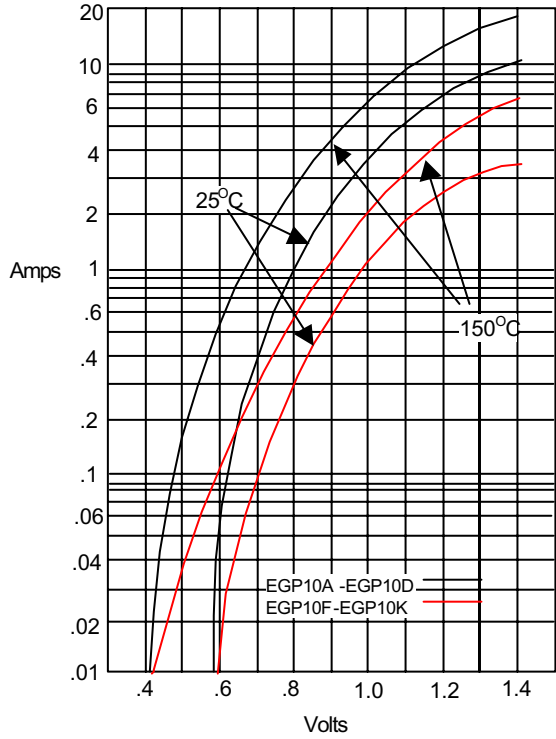

Instantaneous Forward Current - Amperes versus
Instantaneous Forward Voltage - Volts

Figure 2
Forward Derating Curve

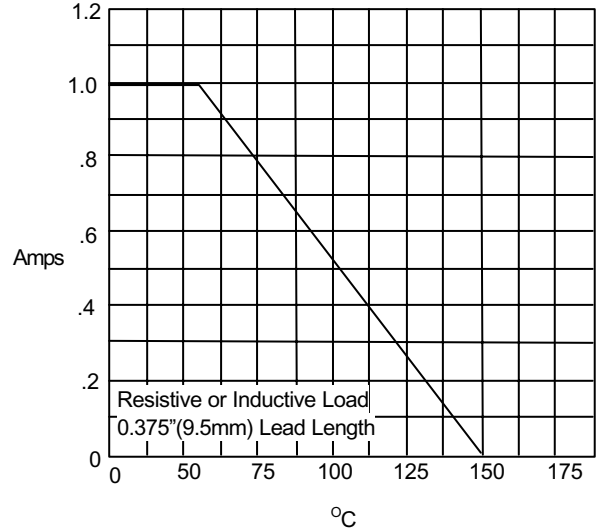

Average Forward Rectified Current - Amperes versus
Ambient Temperature - °C

Figure 3
Junction Capacitance

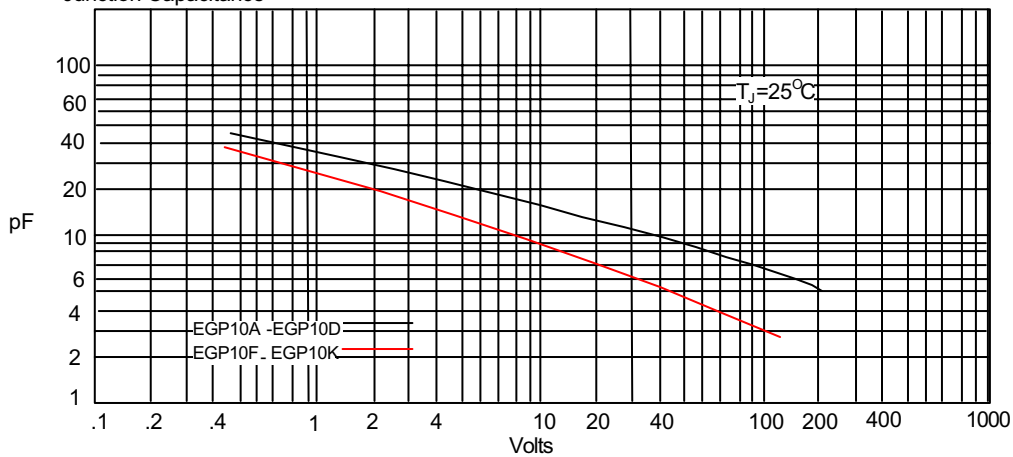

Junction Capacitance - pF versus
Reverse Voltage - Volts

EGP10A thru EGP10K

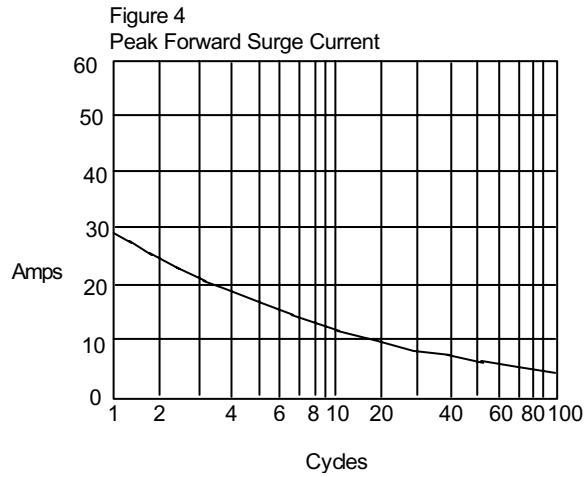

Peak Forward Surge Current - Amperes versus Number Of Cycles At 60Hz - Cycles

Figure 5
Reverse Recovery Time Characteristic And Test Circuit Diagram

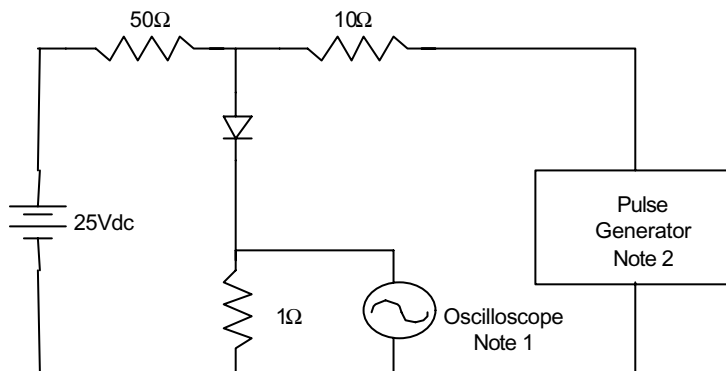

- Notes:
1. Rise Time = 7ns max.
Input impedance = 1 megohm, 22pF
 2. Rise Time = 10ns max.
Source impedance = 50 ohms
 3. Resistors are non-inductive

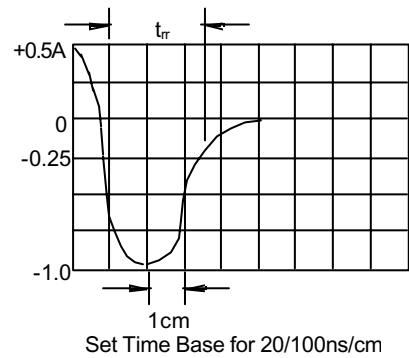



Micro Commercial Components

Ordering Information

Device	Packing
(Part Number)-TP	Tape&Reel; 5Kpcs/Reel
(Part Number)-AP	Ammo Packing;5Kpcs/AmmoBox
(Part Number)-BP	Bulk;1Kpcs/Box

*****IMPORTANT NOTICE*****

Micro Commercial Components Corp. reserves the right to make changes without further notice to any product herein to make corrections, modifications, enhancements, improvements, or other changes. *Micro Commercial Components Corp.* does not assume any liability arising out of the application or use of any product described herein; neither does it convey any license under its patent rights, nor the rights of others. The user of products in such applications shall assume all risks of such use and will agree to hold *Micro Commercial Components Corp.* and all the companies whose products are represented on our website, harmless against all damages.

*****APPLICATIONS DISCLAIMER*****

Products offer by *Micro Commercial Components Corp.* are not intended for use in Medical, Aerospace or Military Applications.