

MCK100-8

Silicon Controlled Rectifier

FEATURES

- Repetitive Peak Off-State Voltage: 600V
- R.M.S On-State Current ($I_{T(RMS)} = 1A$)
- Low Gate Trigger Current: 200uA

Applications

Leakage detector, Electronic Ballast or protection circuit.

General Description

Semihow's SCR product is a single directional PNP device, has a low gate trigger current and high stability in gate trigger current to temperature, generally suitable for sensing and detection circuits.

$$V_{DRM} = 600 V$$

$$I_{T(RMS)} = 1 A$$

$$I_{TSM} = 11 A$$

$$I_{GT} = 200\mu A$$

Symbol

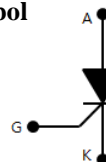

SOT-89

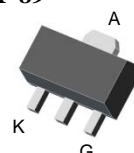

Absolute Maximum Ratings ($T_J=25^\circ C$ unless otherwise specified)

Symbol	Parameter	Conditions	Ratings	Unit
V_{DRM}	Repetitive Peak Off-State Voltage	Sine wave, 50/60Hz, Gate open	600	V
V_{RRM}	Repetitive Peak Reverse Voltage		600	V
$I_{T(AV)}$	Average On-State Current	Full sine wave, $T_C = 80.4^\circ C$	0.64	A
$I_{T(RMS)}$	R.M.S. On-State Current		1	A
I_{TSM}	Surge On-State Current	½ cycle, 50Hz/60Hz, Sine wave, Non repetitive	10/11	A
I^2t	Fusing Current	$t = 10ms$	0.5	A ² S
P_{GM}	Forward Peak Gate Power Dissipation	$T_J = 125^\circ C$, pulse width $\leq 1.0\mu s$	2	W
$P_{G(AV)}$	Forward Average Gate Power Dissipation	$T_J = 125^\circ C$, $t = 8.3ms$	0.1	W
I_{FGM}	Forward Peak Gate Current	$T_J = 125^\circ C$, pulse width $\leq 1.0\mu s$	1	A
V_{RGM}	Reverse Peak Gate Voltage	$T_J = 125^\circ C$, pulse width $\leq 1.0\mu s$	5	V
T_J	Operating Junction Temperature		-40~+125	$^\circ C$
T_{STG}	Storage Temperature		-40~+150	$^\circ C$

Electrical Characteristics ($T_C=25^\circ\text{C}$ unless otherwise specified)

Symbol	Parameter	Conditions	Min	Typ	Max	Unit	
I_{DRM}	Repetitive Peak Off-State Current	$V_D = V_{\text{DRM}}$	$T_C=25^\circ\text{C}$	-	-	50	μA
			$T_C=125^\circ\text{C}$	-	-	5	mA
I_{RRM}	Repetitive Peak Reverse Current	$V_D = V_{\text{DRM}}$	$T_C=25^\circ\text{C}$	-	-	50	μA
			$T_C=125^\circ\text{C}$	-	-	5	mA
I_{GT}	Gate Trigger Current	$V_D = 12\text{V}, R_L=330\Omega$	-	-	200	μA	
V_{GT}	Gate Trigger Voltage	$V_D = 12\text{V}, R_L=330\Omega$	-	-	1.0	V	
V_{GD}	Non-Trigger Gate Voltage ¹	$V_D = 12\text{V}, R_L=330\Omega, T_J=125^\circ\text{C}$	0.2	-	-	V	
V_{TM}	Peak On-State Voltage	$I_T = 1.4\text{A}, I_G = 5\text{mA}$	-	1.2	1.6	V	
dv/dt	Critical Rate of Rise of Off-State Voltage	$V_D = 2/3 V_{\text{DRM}}, T_J=125^\circ\text{C}$	10	-	-	$\text{V}/\mu\text{s}$	
I_{H}	Holding current	$I_T = 0.2\text{A}$	-	-	2	mA	

Notes :

1. Pulse Width $\leq 1.0\text{ms}$, Duty Cycle $\leq 1\%$

Thermal Characteristics

Symbol	Parameter	Conditions	Min	Typ	Max	Unit
$R_{\theta\text{JC}}$	Thermal Resistance	Junction to Case			56	$^\circ\text{C}/\text{W}$
$R_{\theta\text{JA}}$	Thermal Resistance	Junction to Ambient			150	$^\circ\text{C}/\text{W}$

Typical Characteristics

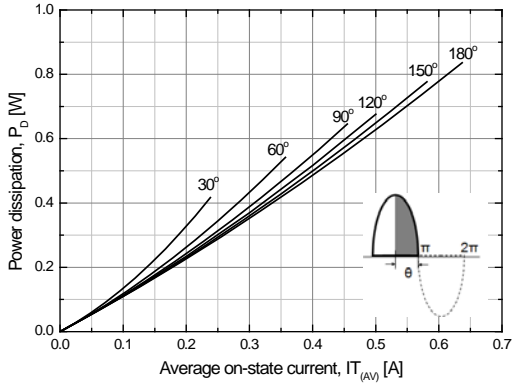

Fig 1. Average Current vs. Power dissipation

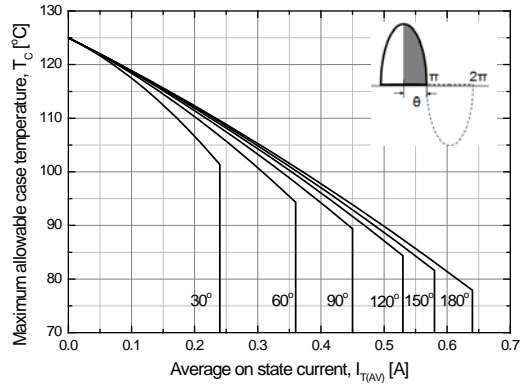

Fig 2. Average current vs. Case Temperature

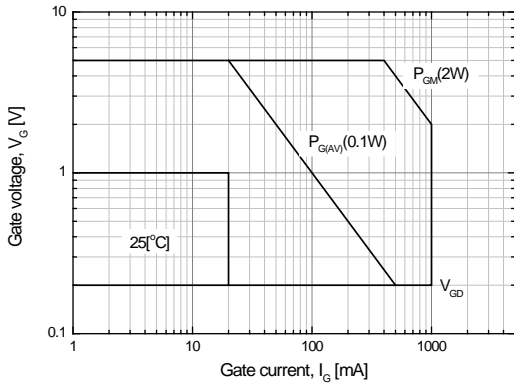

Fig 3. Gate power characteristics

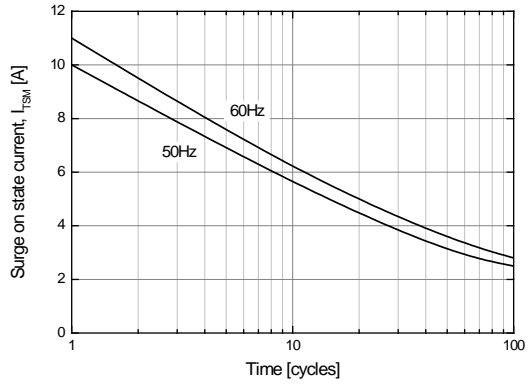

Fig 4. Surge on state current rating (Non-repetitive)

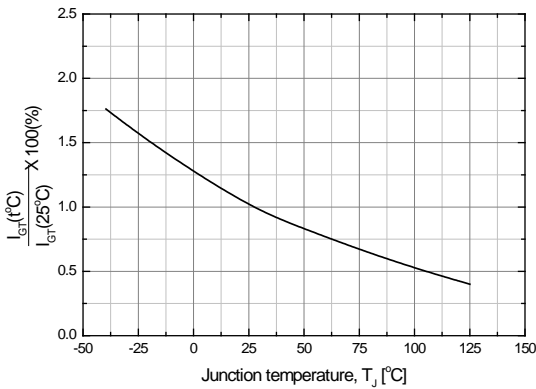

Fig 5. Gate trigger current vs. junction temperature

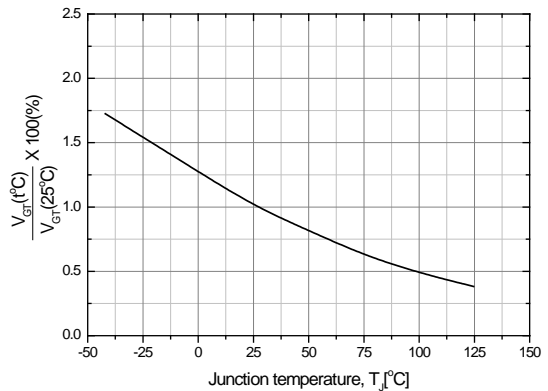

Fig 6. Gate trigger voltage vs. junction temperature

Typical Characteristics

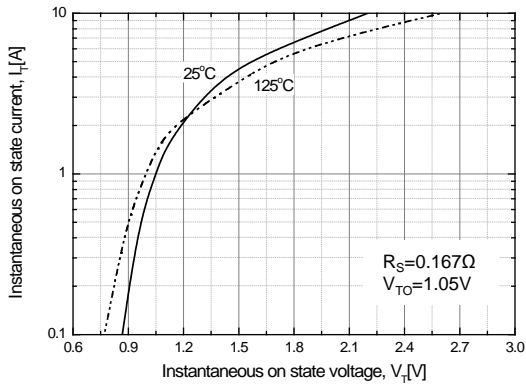

Fig 7. Instantaneous on state current vs. Instantaneous on state voltage

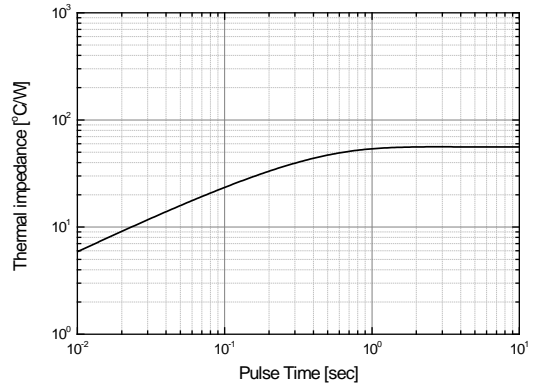
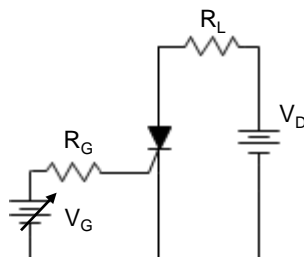

Fig 8. Thermal Impedance vs. pulse time

Measurement of gate trigger current



Note. Whole parameter and test condition can not be over absolute maximum ratings in this datasheet.

Package Dimension

SOT-89-3L

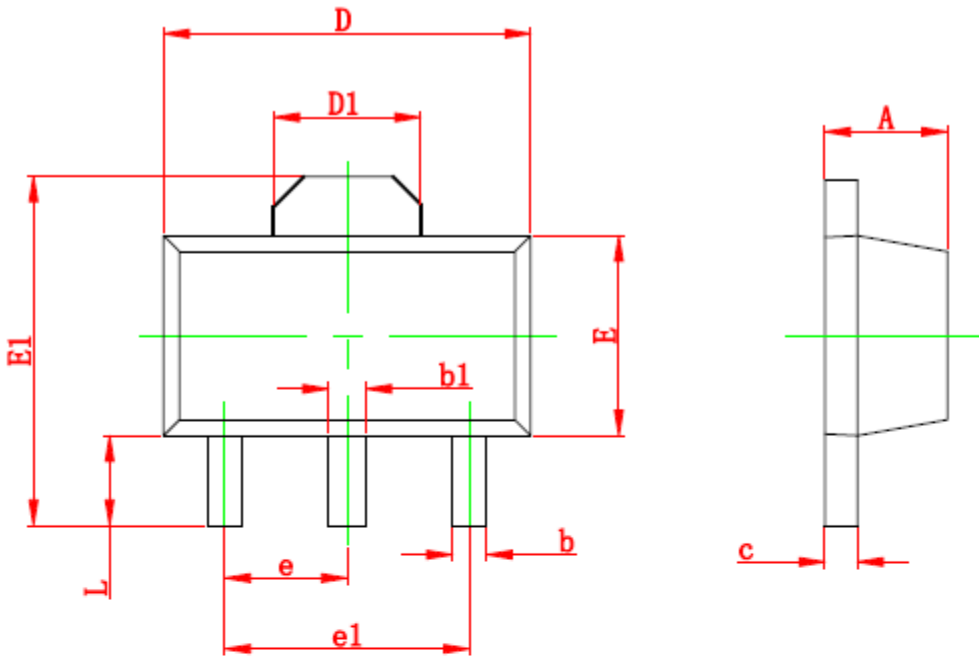

Symbol	Dimensions In Millimeters		Dimensions In Inches	
	Min	Max	Min	Max
A	1.400	1.600	0.055	0.063
b	0.320	0.520	0.013	0.020
b1	0.400	0.580	0.016	0.023
c	0.350	0.440	0.014	0.017
D	4.400	4.600	0.173	0.181
D1	1.550 REF.		0.061 REF.	
E	2.300	2.600	0.091	0.102
E1	3.940	4.250	0.155	0.167
e	1.500 TYP.		0.060 TYP.	
e1	3.000 TYP.		0.118 TYP.	
L	0.900	1.200	0.035	0.047