

HTP6A60H/HTP6A80H

3 Quadrants Standard TRIAC

FEATURES

- ❑ Repetitive Peak Off-State Voltage : 600V/800V
- ❑ R.M.S On-State Current ($I_{T(RMS)} = 6A$)
- ❑ Gate Trigger Current : 25mA
- ❑ High commutation capability.

Applications

General purpose of AC switching, heating control, motor control, etc

General Description

Semihow's standard TRIAC product is a glass passivated device, has a high commutative performance, stable gate triggering level to temperature and high off state voltage. It is generally suitable for power and phase control in ac application

Absolute Maximum Ratings ($T_J=25^\circ\text{C}$ unless otherwise specified)

$$V_{DRM} = 600V/800V$$

$$I_{T(RMS)} = 6 A$$

$$I_{TSM} = 63 A$$

$$I_{GT} = 25mA$$

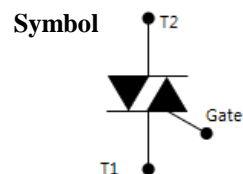

Symbol	Parameter	Conditions	Ratings		Unit
			HTP6A60H	HTP6A80H	
V_{DRM}	Repetitive Peak Off-State Voltage	Sine wave, 50/60Hz, Gate open	600	800	V
V_{RRM}	Repetitive Peak Reverse Voltage		600	800	V
$I_{T(AV)}$	Average On-State Current	Full sine wave, $T_C = 97.6^\circ\text{C}$	5.4		A
$I_{T(RMS)}$	R.M.S. On-State Current		6		A
I_{TSM}	Surge On-State Current	½ cycle, 50Hz/60Hz, Sine wave, Non repetitive	60/63		A
I^2t	Fusing Current	$t = 10\text{ms}$	18		A ² S
P_{GM}	Forward Peak Gate Power Dissipation	$T_J = 125^\circ\text{C}$	5		W
$P_{G(AV)}$	Forward Average Gate Power Dissipation	$T_J = 125^\circ\text{C}$, over any 20ms	0.5		W
I_{FGM}	Forward Peak Gate Current	$T_J = 125^\circ\text{C}$, pulse width $\leq 20\mu\text{s}$	2		A
V_{RGM}	Reverse Peak Gate Voltage	$T_J = 125^\circ\text{C}$, pulse width $\leq 20\mu\text{s}$	10		V
T_J	Operating Junction Temperature		-40~+150		$^\circ\text{C}$
T_{STG}	Storage Temperature		-40~+150		$^\circ\text{C}$

Electrical Characteristics ($T_J=25^\circ\text{C}$ unless otherwise specified)

Symbol	Parameter	Conditions	Min	Typ	Max	Unit	
I_{DRM}	Repetitive Peak Off-State Current	$V_D = V_{\text{DRM}}$	$T_J=25^\circ\text{C}$	-	-	50	μA
			$T_J=125^\circ\text{C}$	-	-	5	mA
I_{RRM}	Repetitive Peak Reverse Current	$V_D = V_{\text{DRM}}$	$T_J=25^\circ\text{C}$	-	-	50	μA
			$T_J=125^\circ\text{C}$	-	-	5	mA
I_{GT}	Gate Trigger Current	$V_D = 12\text{V}, R_L=330\Omega$	1+, 1-, 3-	-	-	25	mA
V_{GT}	Gate Trigger Voltage	$V_D = 12\text{V}, R_L=330\Omega$	1+, 1-, 3-	-	-	1.5	V
V_{GD}	Non-Trigger Gate Voltage ¹	$V_D = 12\text{V}, R_L=330\Omega, T_J=125^\circ\text{C}$		0.2	-	-	V
V_{TM}	Peak On-State Voltage	$I_T = 8.5\text{A}, I_G = 20\text{mA}$		-	1.2	1.5	V
dv/dt	Critical Rate of Rise of Off-State Voltage	$V_D = 2/3 V_{\text{DRM}}, T_J=125^\circ\text{C}$		200	-	-	$\text{V}/\mu\text{s}$
I_{H}	Holding current	$I_T = 0.2\text{A}$		-	45	-	mA

Notes :

1. Pulse Width $\leq 1.0\text{ms}$, Duty Cycle $\leq 1\%$

Thermal Characteristics

Symbol	Parameter	Conditions	Min	Typ	Max	Unit
$R_{\theta\text{JC}}$	Thermal Resistance	Junction to Case			3.9	$^\circ\text{C}/\text{W}$
$R_{\theta\text{JA}}$	Thermal Resistance	Junction to Ambient			58	$^\circ\text{C}/\text{W}$

Typical Characteristics

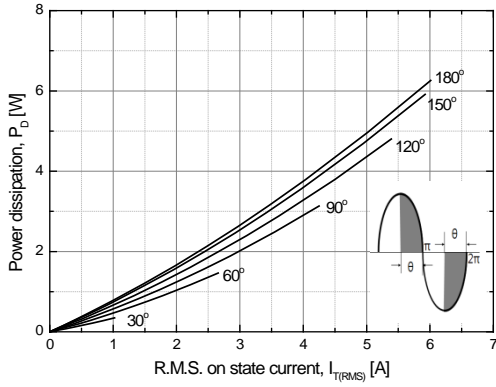

Fig 1. R.M.S. current vs. Power dissipation

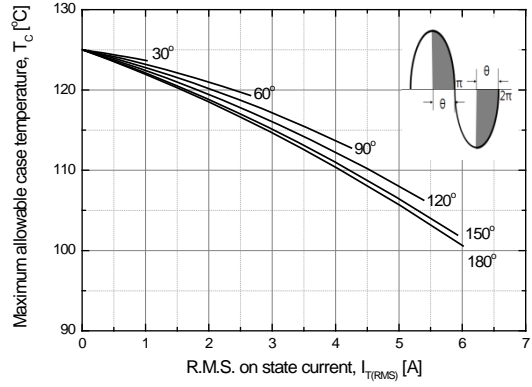

Fig 2. R.M.S. current vs. Case temperature

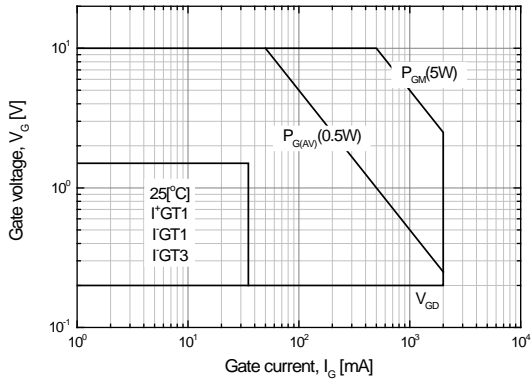

Fig 3. Gate power characteristics

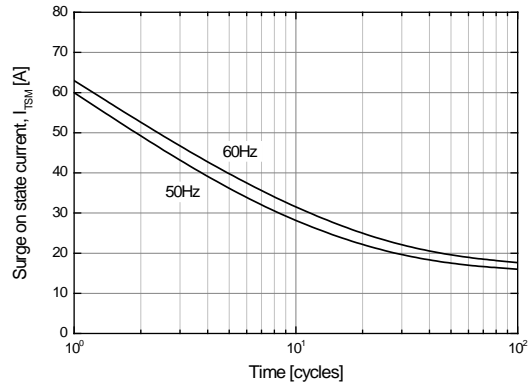

Fig 4. Surge on state current rating (Non-repetitive)

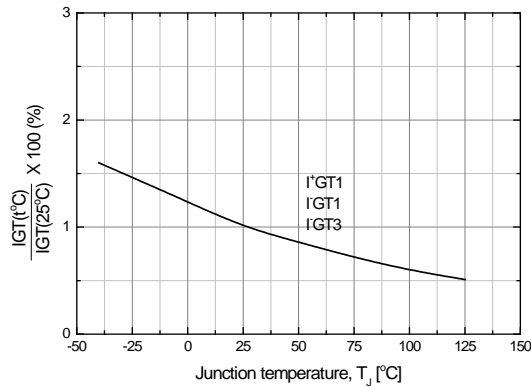

Fig 5. Gate trigger current vs. junction temperature

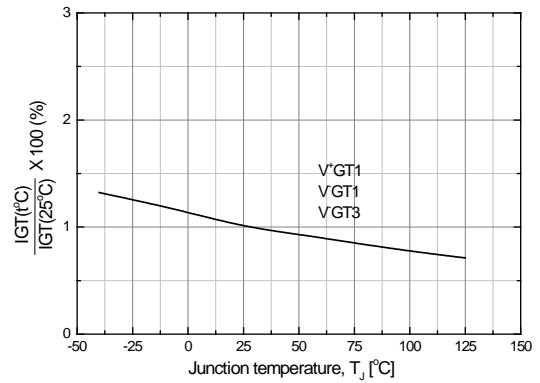

Fig 6. Gate trigger voltage vs. junction temperature

Typical Characteristics

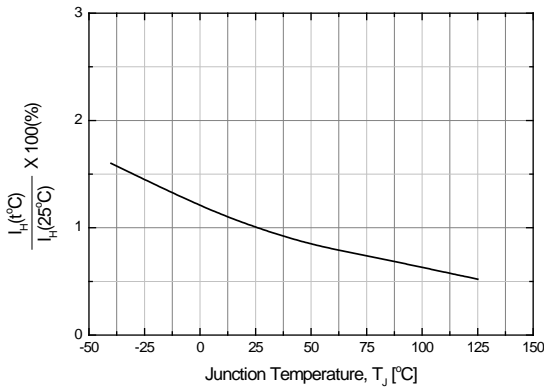

Fig 7. Holding current vs. Junction temperature

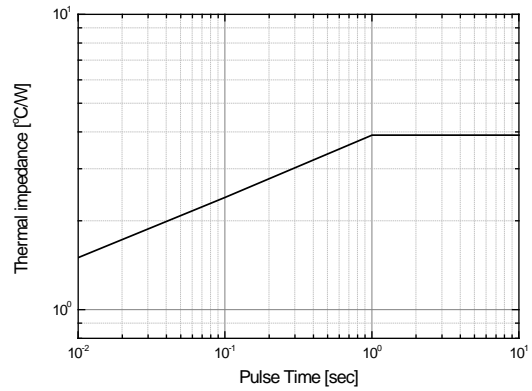

Fig 8. Thermal Impedance vs. pulse time

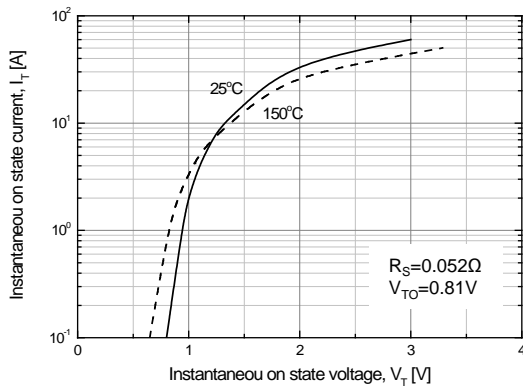
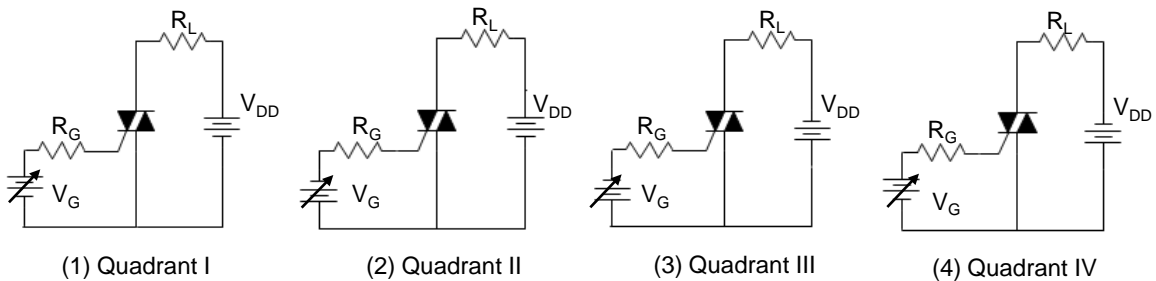

Fig 9. Instantaneous on state current vs. Instantaneous on state voltage

Measurement of gate trigger current



Note. Whole parameter and test condition can not be over absolute maximum ratings in this datasheet.

Package Dimension

TO-220 (A)

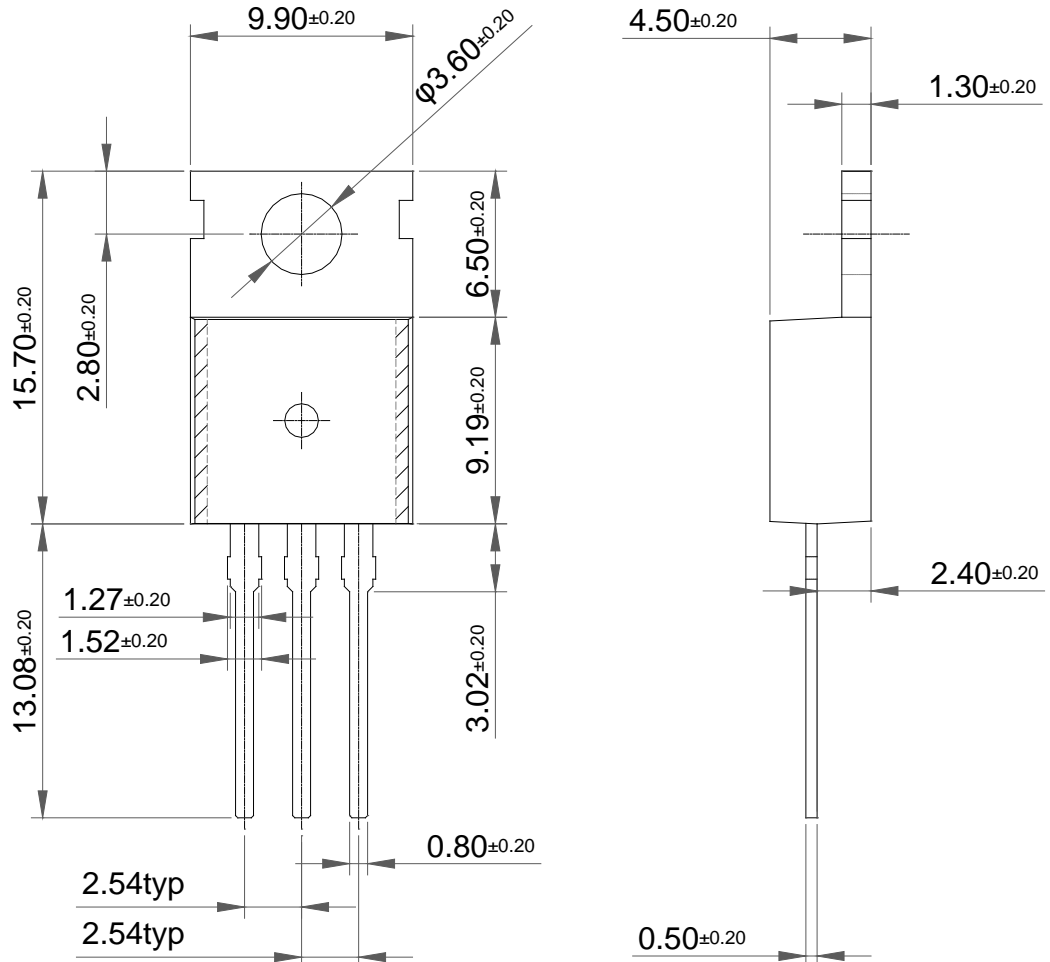

HTP6A60H_HTP6A80H

Package Dimension

TO-220 (B)

