

# HTK1A60/KTK1A80

## 4 Quadrants Sensitive TRIAC

### FEATURES

- ❑ Repetitive Peak Off-State Voltage : 600V/800V
- ❑ R.M.S On-State Current ( $I_{T(RMS)} = 1A$ )
- ❑ Sensitive Gate Trigger Current
  - 5[mA] of IGT at I, II and III Quadrants.
  - 12[mA] of IGT at IV Quadrant.

### Applications

AC power or phase control through low output current of MCU or IC suck like Heater, Solenoid valve control, etc.

### General Description

Semihow's sensitive TRIAC product is a glass passivated device, has a low gate trigger current, high stability in gate trigger current to variation of operating temperature and high off state voltage. It is generally suitable for power and phase control in ac application.

### Absolute Maximum Ratings ( $T_J=25^\circ\text{C}$ unless otherwise specified )

Symbol	Parameter	Conditions	Ratings		Unit
			HTK1A60	HTK1A80	
$V_{DRM}$	Repetitive Peak Off-State Voltage	Sine wave, 50/60Hz, Gate open	600	800	V
$V_{RRM}$	Repetitive Peak Reverse Voltage		600	800	V
$I_{T(AV)}$	Average On-State Current	Full sine wave, $T_C = 72^\circ\text{C}$	0.9		A
$I_{T(RMS)}$	R.M.S. On-State Current		1		A
$I_{TSM}$	Surge On-State Current	½ cycle, 50Hz/60Hz, Sine wave, Non repetitive	12/13		A
$I^2t$	Fusing Current	$t = 10\text{ms}$	0.7		A <sup>2</sup> S
$P_{GM}$	Forward Peak Gate Power Dissipation	$T_J = 125^\circ\text{C}$	2		W
$P_{G(AV)}$	Forward Average Gate Power Dissipation	$T_J = 125^\circ\text{C}$ , over any 20ms	0.2		W
$I_{FGM}$	Forward Peak Gate Current	$T_J = 125^\circ\text{C}$ , pulse width $\leq 20\mu\text{s}$	0.5		A
$V_{RGM}$	Reverse Peak Gate Voltage	$T_J = 125^\circ\text{C}$ , pulse width $\leq 20\mu\text{s}$	6		V
$T_J$	Operating Junction Temperature		-40~+125		$^\circ\text{C}$
$T_{STG}$	Storage Temperature		-40~+150		$^\circ\text{C}$

$$V_{DRM} = 600\text{V}/800\text{V}$$

$$I_{T(RMS)} = 1\text{ A}$$

$$I_{TSM} = 13\text{ A}$$

$$I_{GT} = 5\text{mA}/12\text{mA}$$

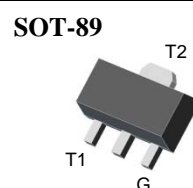
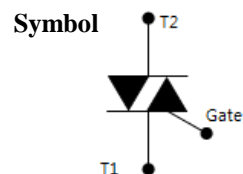

## Electrical Characteristics ( $T_J=25^\circ\text{C}$ unless otherwise specified )

Symbol	Parameter	Conditions	Min	Typ	Max	Unit	
$I_{DRM}$	Repetitive Peak Off-State Current	$V_D = V_{DRM}$	$T_J=25^\circ\text{C}$	-	-	50	$\mu\text{A}$
			$T_J=125^\circ\text{C}$	-	-	5	$\text{mA}$
$I_{RRM}$	Repetitive Peak Reverse Current	$V_D = V_{DRM}$	$T_J=25^\circ\text{C}$	-	-	50	$\mu\text{A}$
			$T_J=125^\circ\text{C}$	-	-	5	$\text{mA}$
$I_{GT}$	Gate Trigger Current	$V_D = 12\text{V}, R_L=330\Omega$	1+, 1-, 3-	-	-	5	$\text{mA}$
			3+	-	-	12	$\text{mA}$
$V_{GT}$	Gate Trigger Voltage	$V_D = 12\text{V}, R_L=330\Omega$	1+, 1-, 3-	-	-	1.5	$\text{V}$
			3+	-	-	2.0	$\text{V}$
$V_{GD}$	Non-Trigger Gate Voltage <sup>1</sup>	$V_D = 12\text{V}, R_L=330\Omega, T_J=125^\circ\text{C}$	0.2	-	-	$\text{V}$	
$V_{TM}$	Peak On-State Voltage	$I_T = 1.4\text{A}, I_G = 20\text{mA}$	-	1.2	1.6	$\text{V}$	
dv/dt	Critical Rate of Rise of Off-State Voltage	$V_D = 2/3 V_{DRM}, T_J=125^\circ\text{C}$	10	-	-	$\text{V}/\mu\text{s}$	
$I_H$	Holding current	$I_T = 0.2\text{A}$	-	-	5	$\text{mA}$	

### Notes :

1. Pulse Width  $\leq 1.0\text{ms}$ , Duty Cycle  $\leq 1\%$

## Thermal Characteristics

Symbol	Parameter	Conditions	Min	Typ	Max	Unit
$R_{\theta JC}$	Thermal Resistance	Junction to Case			48	$^\circ\text{C}/\text{W}$
$R_{\theta JA}$	Thermal Resistance	Junction to Ambient			150	$^\circ\text{C}/\text{W}$

Typical Characteristics

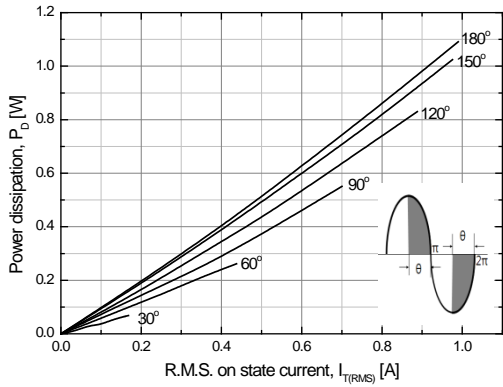

Fig 1. R.M.S. current vs. Power dissipation

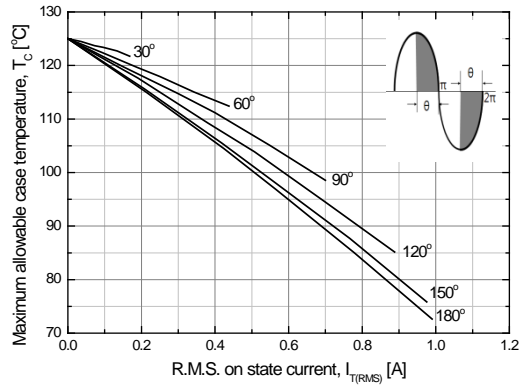

Fig 2. R.M.S. current vs. Case temperature

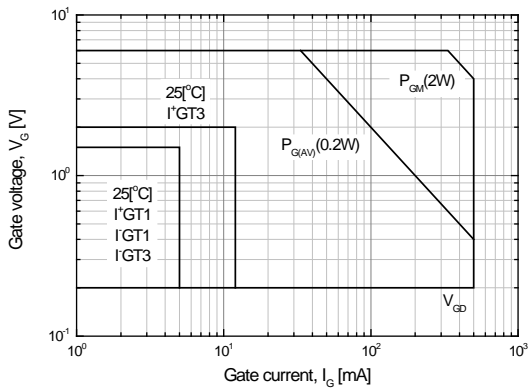

Fig 3. Gate power characteristics

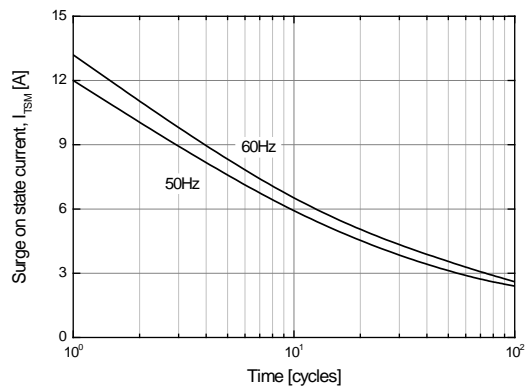

Fig 4. Surge on state current rating (Non-repetitive)

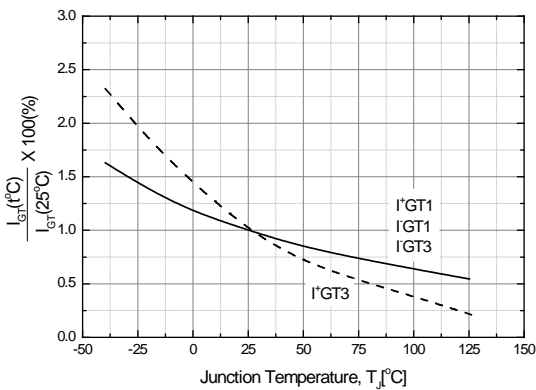

Fig 5. Gate trigger current vs. junction temperature

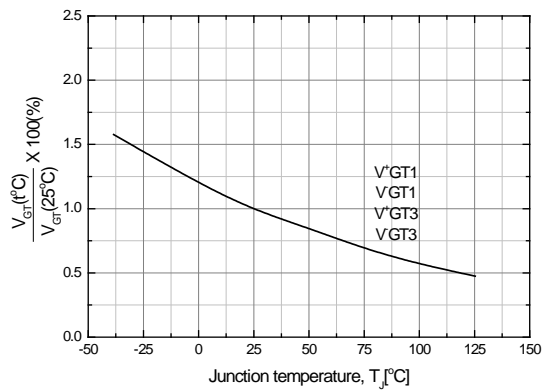

Fig 6. Gate trigger voltage vs. junction temperature

Typical Characteristics

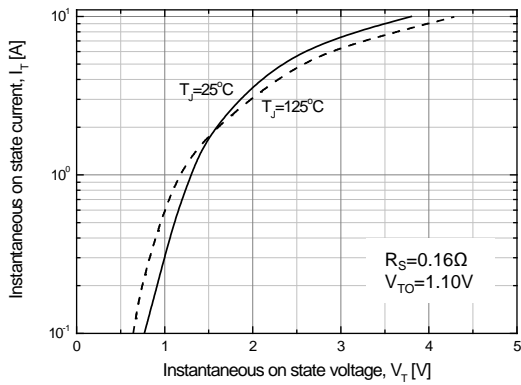

Fig 7. Instantaneous on state current vs. Instantaneous on state voltage

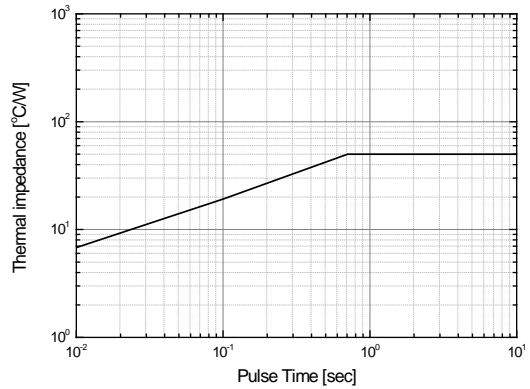
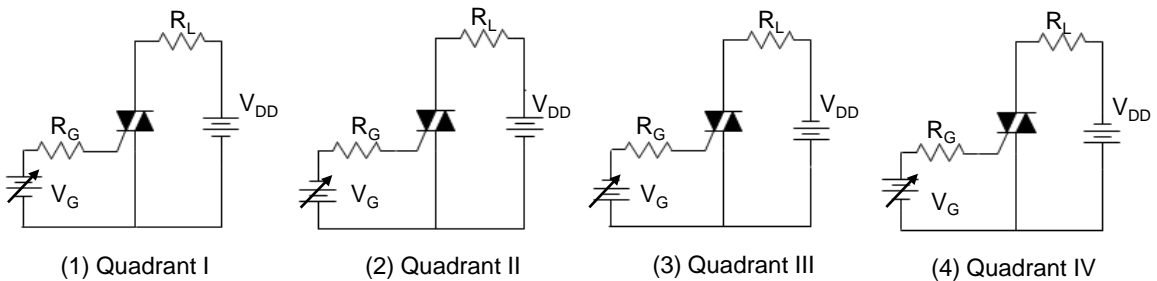

Fig 8. Thermal Impedance vs. pulse time

Measurement of gate trigger current



Note. Whole parameter and test condition can not be over absolute maximum ratings in this datasheet.

## Package Dimension

## SOT-89-3L

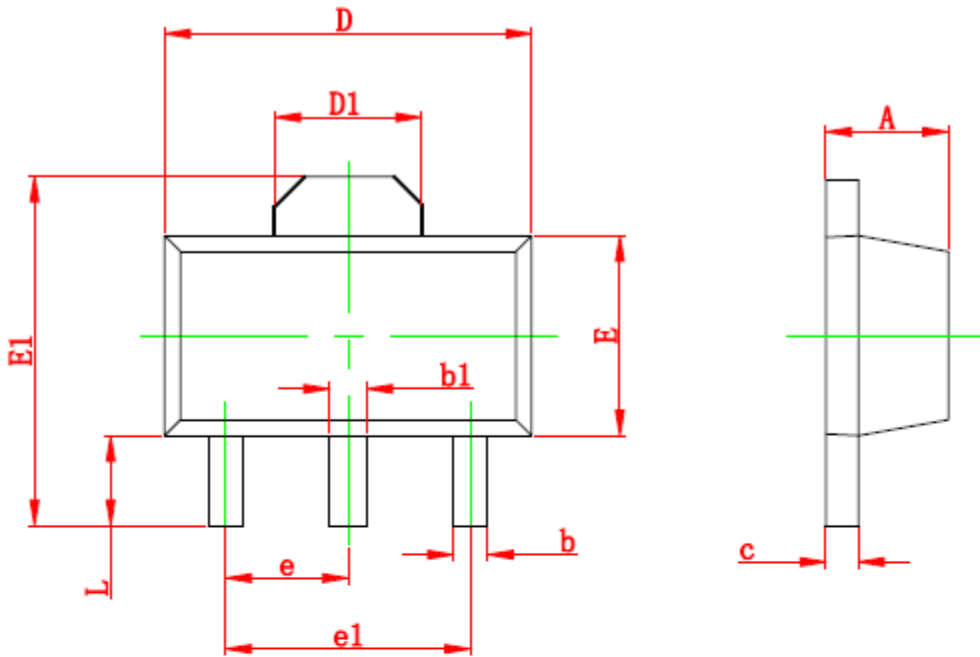

Symbol	Dimensions In Millimeters		Dimensions In Inches	
	Min	Max	Min	Max
A	1.400	1.600	0.055	0.063
b	0.320	0.520	0.013	0.020
b1	0.400	0.580	0.016	0.023
c	0.350	0.440	0.014	0.017
D	4.400	4.600	0.173	0.181
D1	1.550 REF.		0.061 REF.	
E	2.300	2.600	0.091	0.102
E1	3.940	4.250	0.155	0.167
e	1.500 TYP.		0.060 TYP.	
e1	3.000 TYP.		0.118 TYP.	
L	0.900	1.200	0.035	0.047