



DESCRIPTION

This part is suitable for motor control, water heaters, lighting control, induction motor starting circuits, solid-state relays, on/off switching etc. The part is available in TO-3P package and is suitable for general purpose power switching applications.

FEATURES

- TRIAC
- TO-3P Package
- Isolated Heat-sink
- $I_{T(RMS)} = 16\text{ A}$
- $V_{DRM} = 600/800\text{ Volt}$
- $V_{RRM} = 600/800\text{ Volt}$
- $I_{GT} = 30\text{ mA}$

APPLICATIONS

- AC power switching applications
- Washing Machine
- Vacuum Cleaner
- Rice Cookers
- Microwave Ovens
- Hair Dryers
- Copier Machines
- Motor Controls
- Dimmers
- Heater Controls
- Vending Machines

PIN-OUT

TO-3P Package

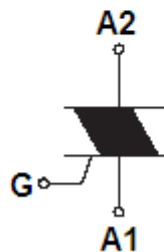



SPECIFICATIONS

ELECTRICAL CHARACTERISTICS ($T_j = 25^\circ\text{C}$)

PARAMETER		MAX VALUE	UNIT
Repetitive Peak Off-State Current, I_{DRM1}	$V_D = 600/800 \text{ V}$	2	mA
Peak On-state Voltage, V_{TM}	$I_T=25\text{A}$	1.4	V
Gate Threshold Current, 1 st quadrant, I_{GT1}^+	$V_D=6\text{V}, R_L=10\Omega$	30	mA
Gate Threshold Current, 2 nd quadrant, I_{GT1}^-	$V_D=6\text{V}, R_L=10\Omega$	30	mA
Gate Threshold Current, 3 rd quadrant, I_{GT3}^+	$V_D=6\text{V}, R_L=10\Omega$	-	mA
Gate Threshold Current, 4 th quadrant, I_{GT3}^-	$V_D=6\text{V}, R_L=10\Omega$	30	mA
Gate Threshold Voltage, 1 st quadrant, V_{GT1}^+	$V_D=6\text{V}, R_L=10\Omega$	1.5	V
Gate Threshold Voltage, 2 nd quadrant, V_{GT1}^-	$V_D=6\text{V}, R_L=10\Omega$	1.5	V
Gate Threshold Voltage, 3 rd quadrant, V_{GT3}^+	$V_D=6\text{V}, R_L=10\Omega$	-	V
Gate Threshold Voltage, 4 th quadrant, V_{GT3}^-	$V_D=6\text{V}, R_L=10\Omega$	1.5	V
Gate-Drain On-Voltage, V_{GD}	$T_j=125^\circ\text{C}, V_D=0.5V_{\text{DRM}}$	0.2	V
dV/dt	$T_j=125^\circ\text{C}, V_D=400\text{V}$ $di/dt=-8\text{A/ms}$	10	V/ μs
Holding Current, I_H		25	mA

MAXIMUM RATINGS ($T_A = 25^\circ\text{C}$)

PARAMETER		VALUE	UNIT
	V_{DRM}	600/800	V
RMS on-state current (full sine wave)	$I_{\text{T(RMS)}}$	16	A
Non-repetitive surge peak current	I_{TSM}	170	A
Value for fusing	I^2t	120	A^2s
Peak gate power dissipation	P_{GM}	5	W
Average peak gate power dissipation	$P_{\text{G(AV)}}$	0.5	W
Peak gate current	I_{GM}	2	A
Peak gate voltage	V_{GM}	10	V
Operating junction temperature	T_j	-40~+125	$^\circ\text{C}$



THERMAL RESISTANCE

PARAMETER	PACKAGE	VALUE	UNIT
$R_{th(j-c)}$	TO-3P Insulated	1.8	°C/W
$R_{th(j-a)}$	TO-3P Insulated	50	°C/W

OTHERS

PARAMETER		MIN	TYP	MAX	UNIT
Isolation Resistance	At 1000VDC, 1 min	-	-	1,000	MΩ
Isolation Voltage	Between pins and heatsink	-	-	1.5	kV
Temperature range		-40	-	125	°C
Relative humidity		35	-	65	%
Shock resistance	Destruction	-	-	100	G
	Malfunction	-	-	100	G
Vibration resistance	Destruction: 10 - 55 Hz	-	-	1.5	mm
	Malfunction: 10 - 55 Hz	-	-	1.5	mm

TRIGGER MODES

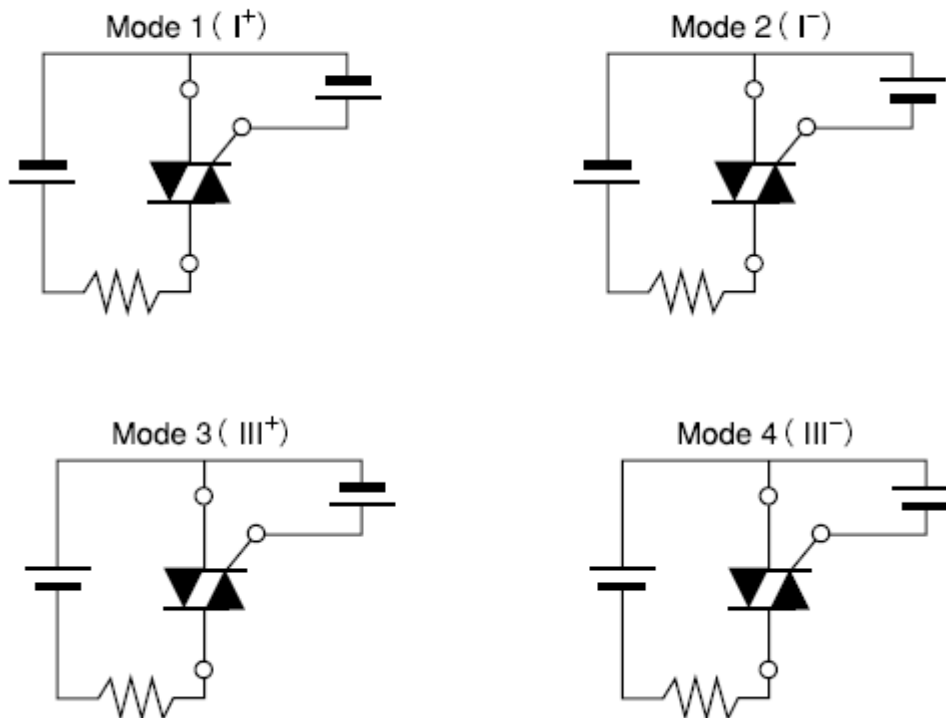



TYPICAL CHARACTERISTICS

GATE CHARACTERISTICS

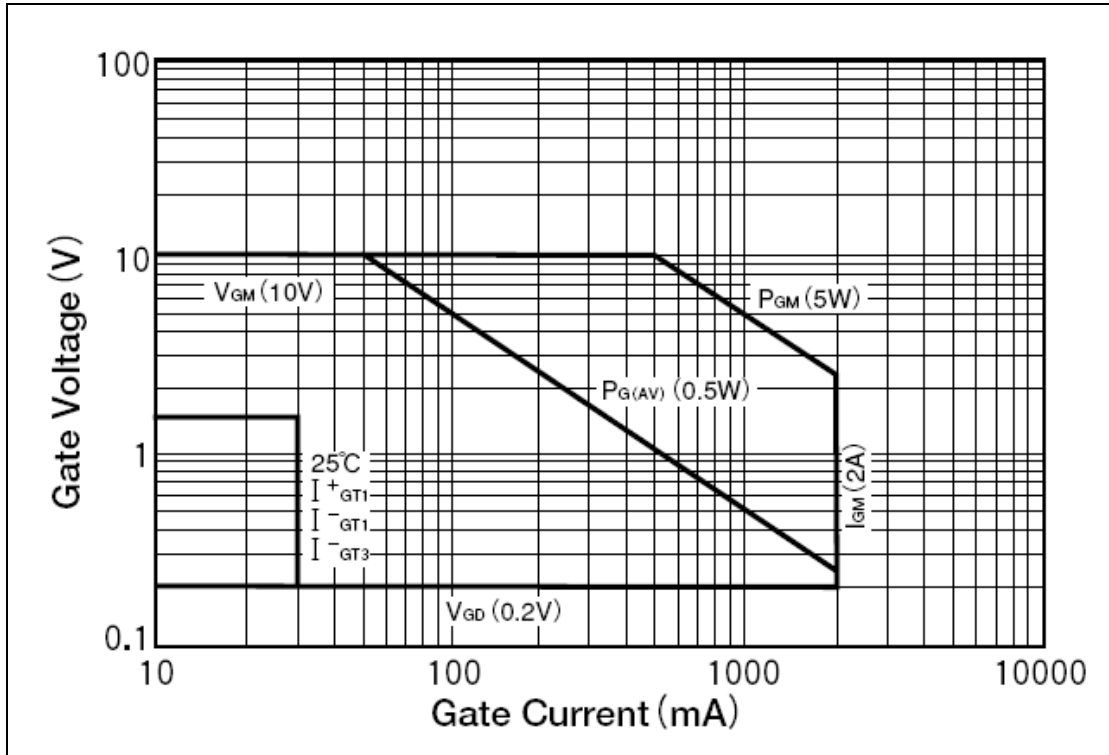

ON-STATE CHARACTERISTICS (MAX)

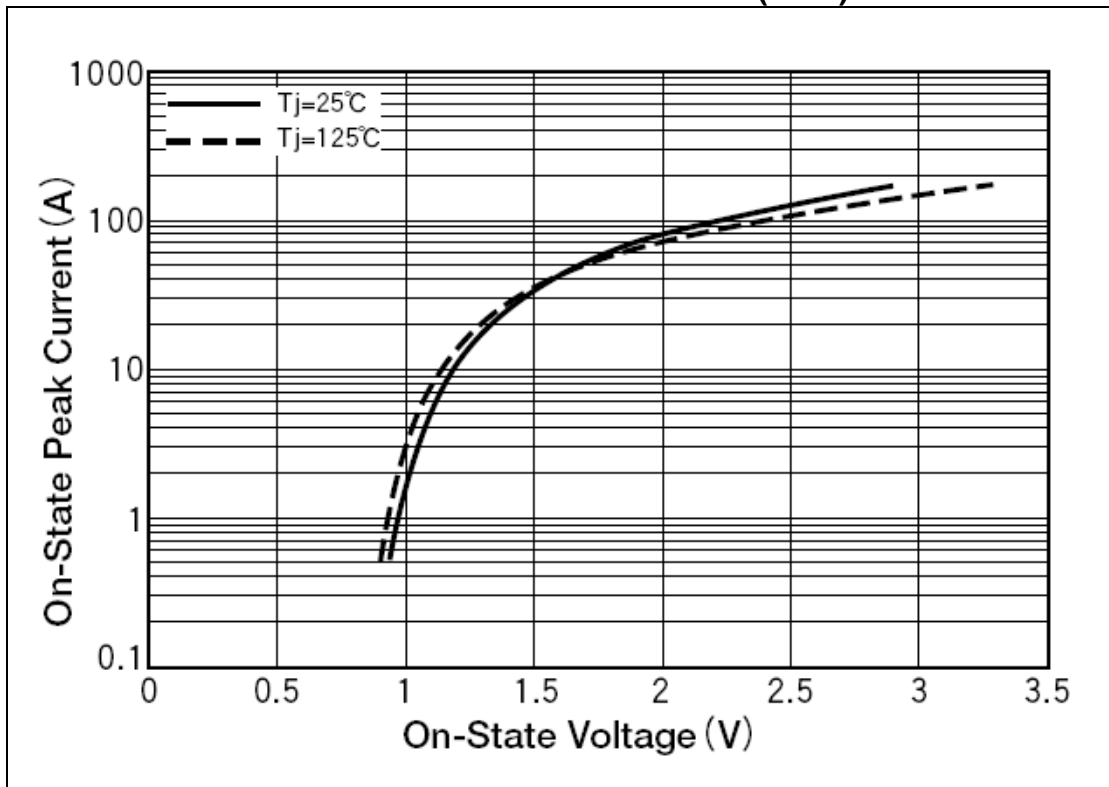



TYPICAL CHARACTERISTICS – CONTINUED

RMS ON-STATE CURRENT VS MAXIMUM POWER DISSIPATION

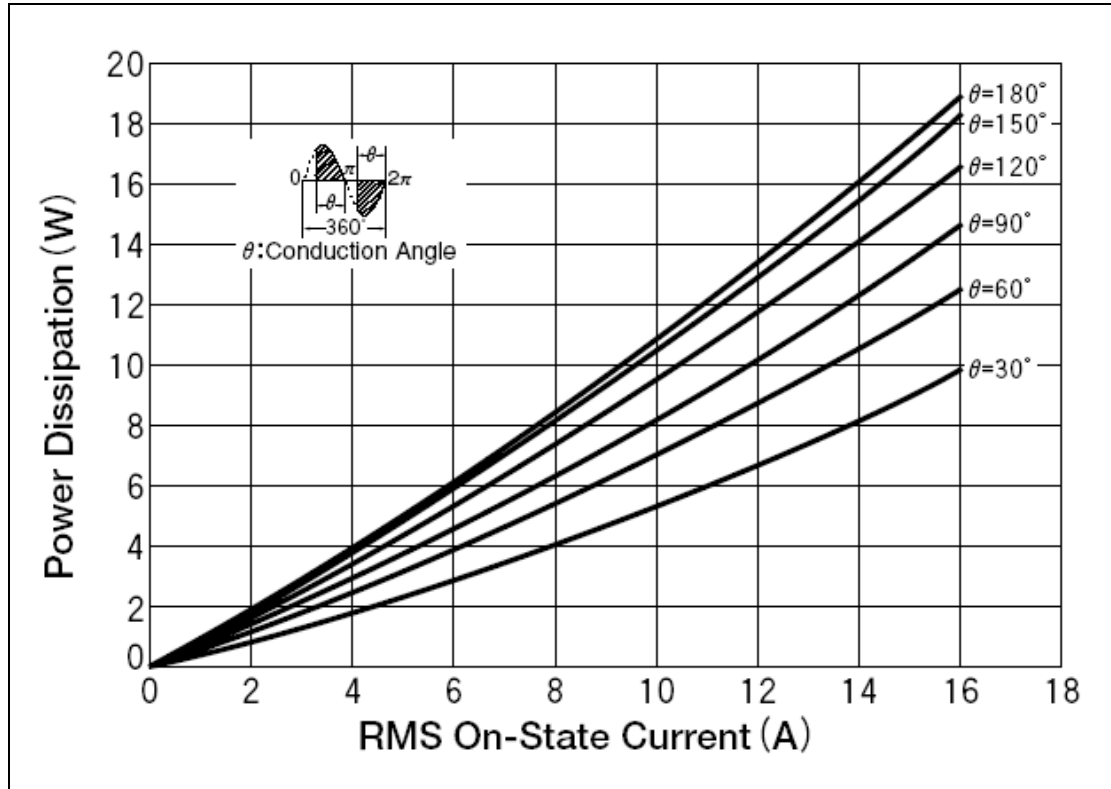

RMS ON-STATE VS ALLOWABLE CASE TEMPERATURE

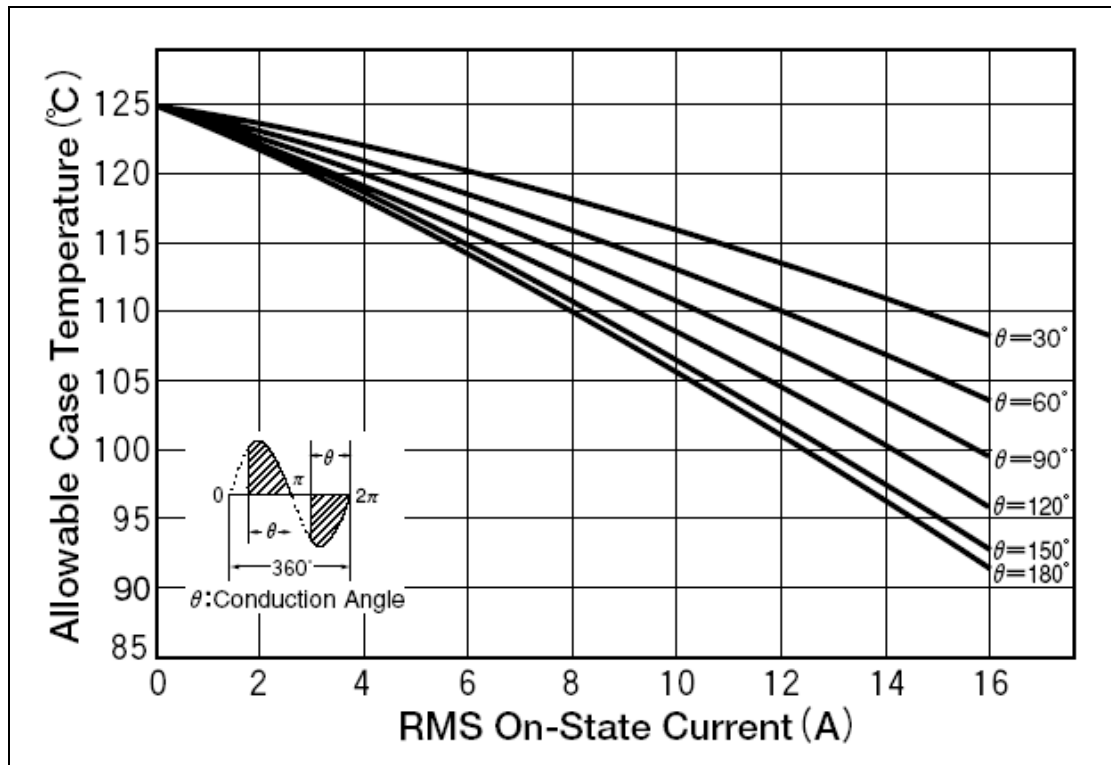



TYPICAL CHARACTERISTICS – CONTINUED

SURGE ON-STATE CURRENT RATING (NON-REPETITIVE)

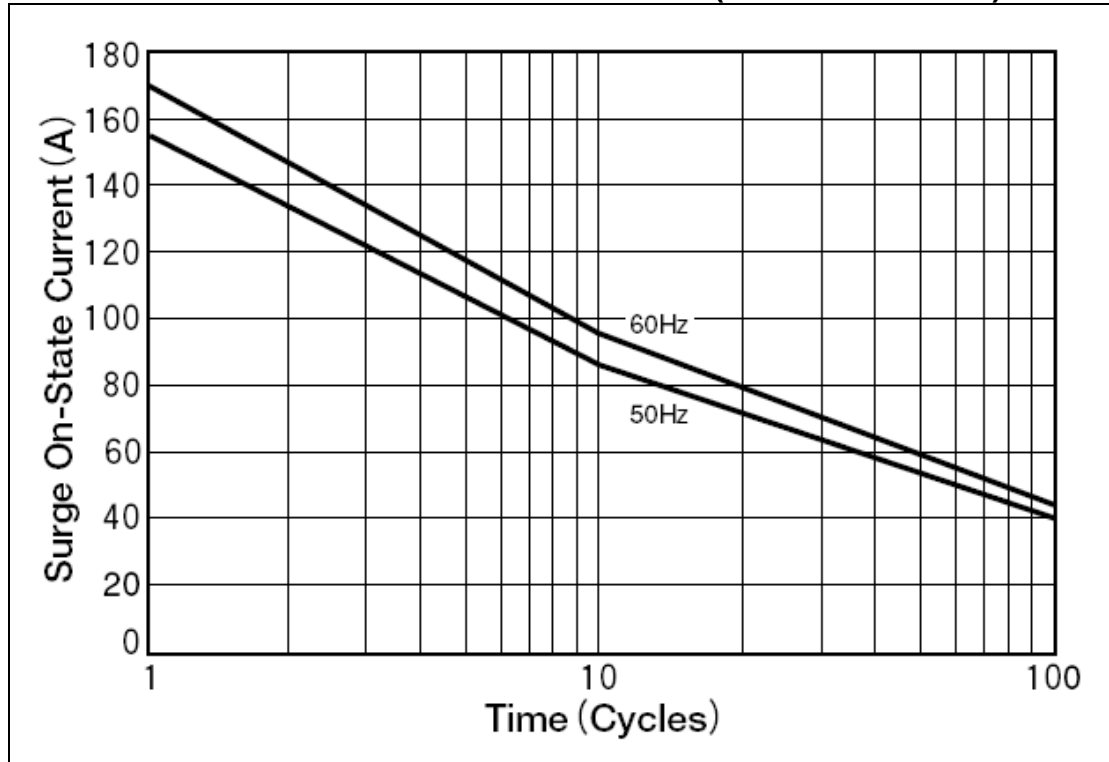

TRANSIENT THERMAL IMPEDANCE

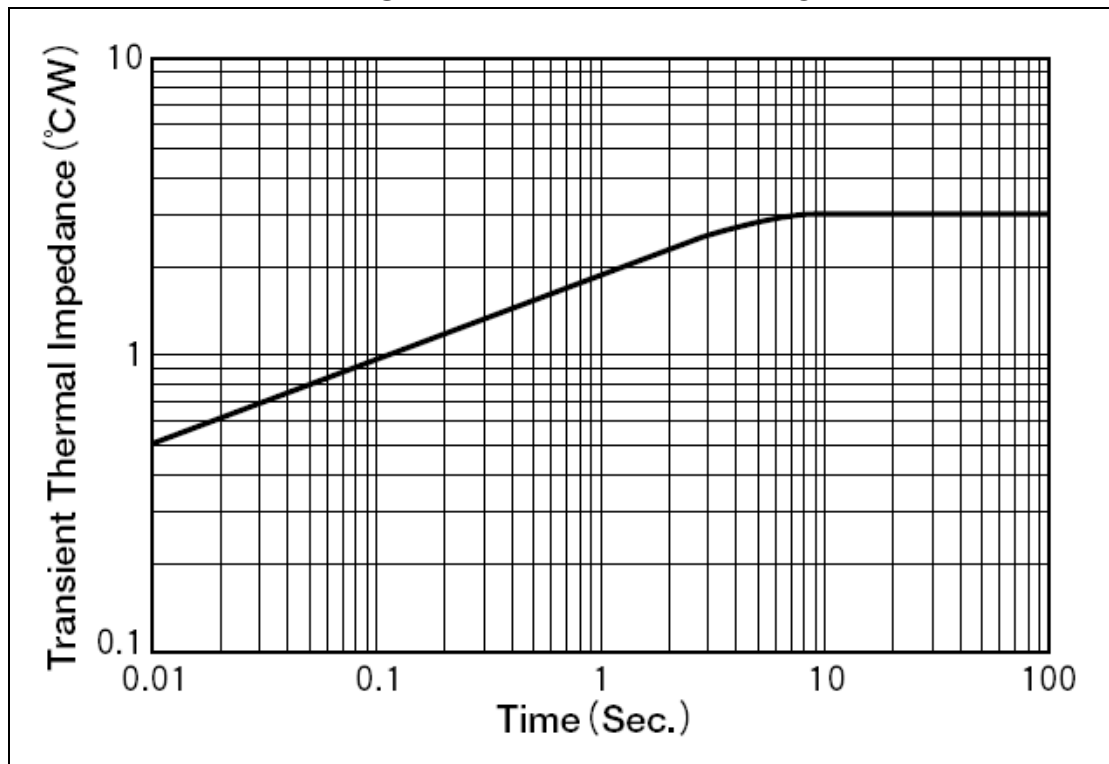



TYPICAL CHARACTERISTICS – CONTINUED

$I_{GT} - T_j$ (TYPICAL)

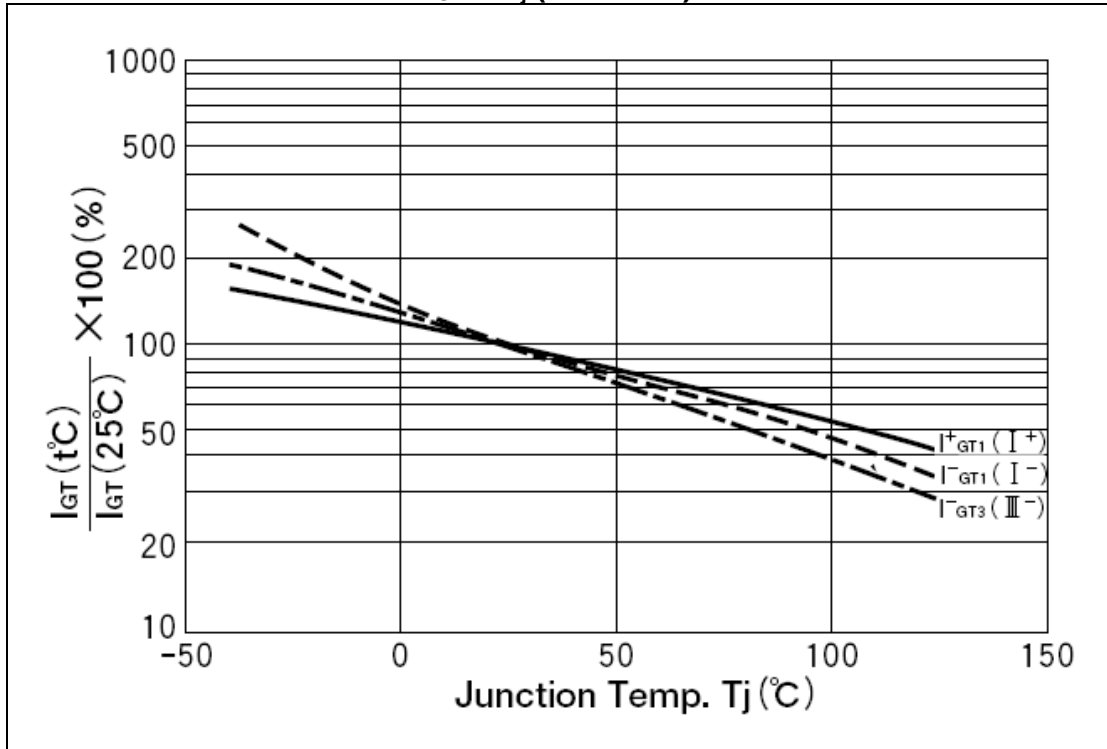

$V_{GT} - T_j$ (TYPICAL)

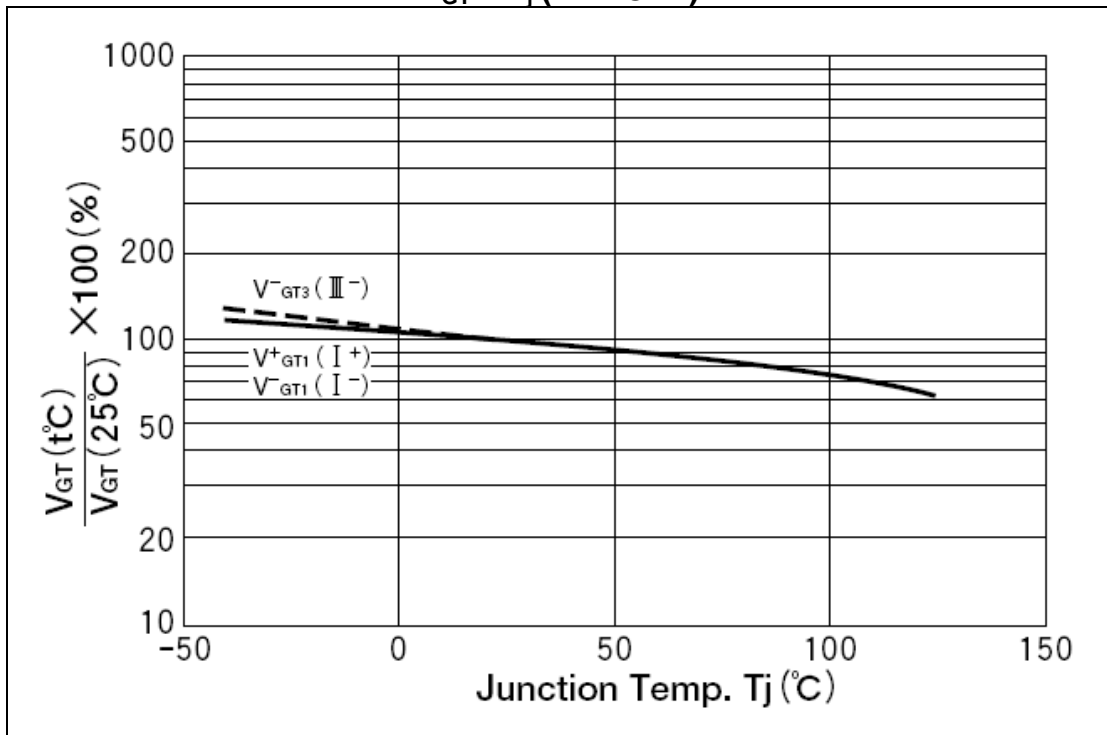



PACKAGING

DIMENSIONS AND MARKING FOR TO-220 PACKAGE

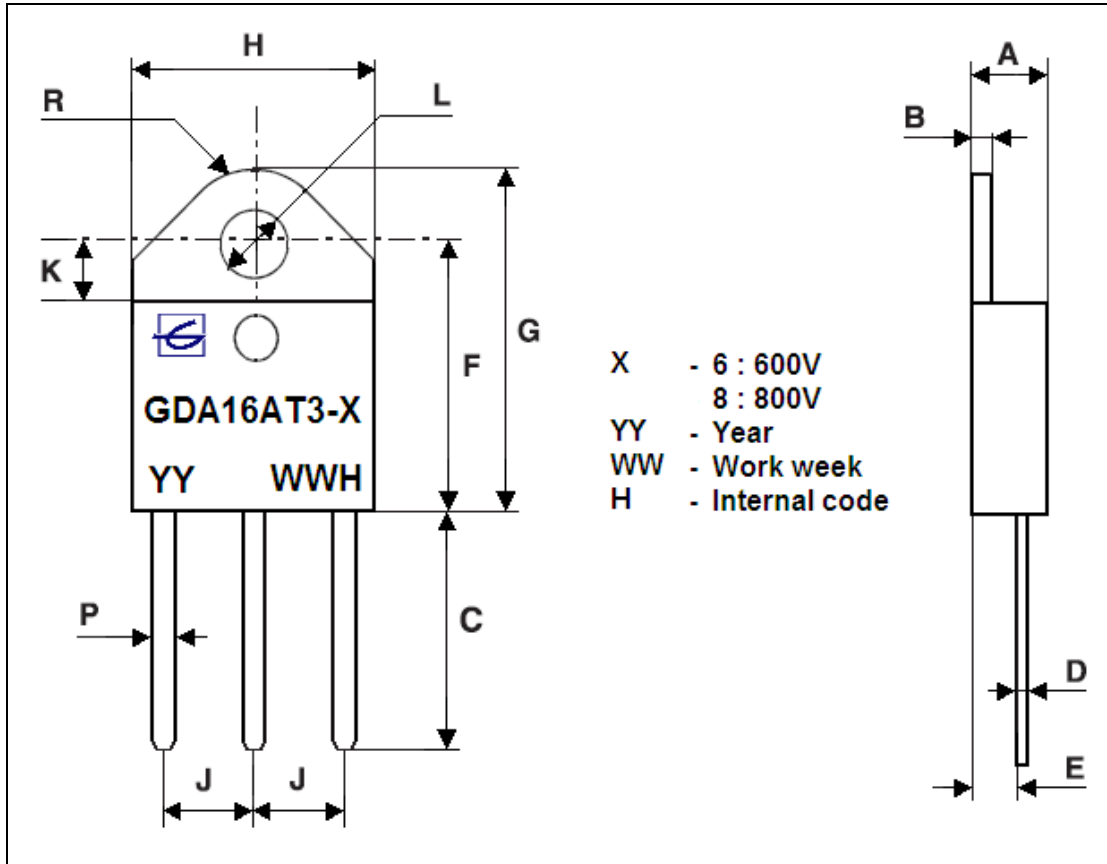

TO-3P		A	B	C	D	E	F	G	H	J	K	L	P	R
MM	Min	4.400	1.45	14.35	0.500	2.70	15.80	20.40	15.10	5.400	3.400	4.080	1.200	
	Typ													4.600
	Max	4.600	1.55	15.60	0.700	2.90	16.50	21.10	15.50	5.650	3.650	4.170	1.400	
INCHES	Min	0.173	0.057	0.565	0.020	0.106	0.622	0.815	0.594	0.213	0.134	0.161	0.047	
	Typ													0.181
	Max	0.181	0.061	0.614	0.028	0.114	0.650	0.831	0.610	0.222	0.144	0.164	0.055	



ORDERING INFORMATION

PART NUMBER	V_{DRM}/V_{RRM} (V)	PACKAGE
GDA16AT3-6	600	TO-3P
GDA16AT3-8	800	TO-3P

The information presented in this data sheet is believed to be accurate and reliable. Application circuits shown are typical examples illustrating the operation of the device.
In the interest of product improvement, GateLevel reserves the right to change specifications and data without notice and can assume no responsibility for the use of any information, devices and application circuits described herein.
Reference to products of other manufacturers are solely for convenience and do not imply total equivalency of design, performance, or otherwise.