

Description

Total power dissipation: Max. 1 W.

Wide zener reverse voltage range 3.3V to 330V.

Small plastic package suitable for surface mounted design.

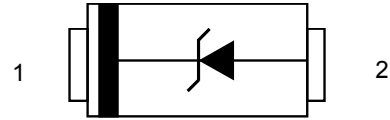

SOD123-FL

Absolute Maximum Ratings And Characteristics (Ta=25°C)

Parameter	Symbol	Value	Unit
Power Dissipation at TL=75°C	P _O	1	W
Forward Voltage at I _F = 200 mA	V _F	1.2	V
Typical thermal resistance junction to ambient ⁽¹⁾	R _{θJA}	55	°C/W
Operating and Storage Temperature Range	T _j , T _{stg}	-55~+150	°C

(1) Thermal resistance from junction to ambient at P.C.B. mounted with 0.2 X 0.2" (5 X 5 mm) copper areas pads.

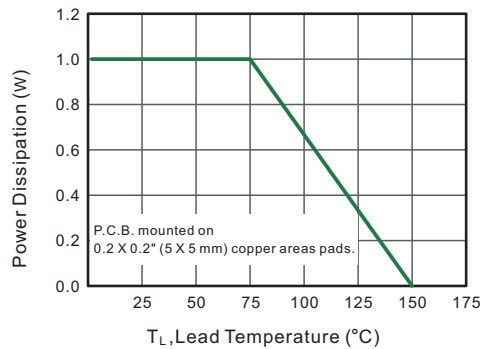

Fig.1 Maximum Continuous Power Derating

Characteristics at Ta = 25°C

Type	Zener Voltage Range (1)			IZT (mA)	Dynamic	Reverse Current		Admissible IZM (mA)
	VZT (at IZT)				ZZT (at IZT)	IR	at VR	
	Min (V)	Nom (V)	Max (V)		Max (Ω)	Max (μA)	(V)	
PMM1W3V3	3.10	3.3	3.50	75	10	100	1	285
PMM1W3V6	3.40	3.6	3.80	69	10	100	1	263
PMM1W3V9	3.70	3.9	4.10	64	9.0	50	1	243
PMM1W4V3	4.05	4.3	4.56	58	9.0	25	1	219
PMM1W4V7	4.50	4.7	4.93	53	8.0	10	1	202
PMM1W5V1	4.84	5.1	5.36	49	7.0	10	1	186
PMM1W5V6	5.32	5.6	5.88	45	5.0	10	2	170
PMM1W6V2	5.89	6.2	6.51	41	2.0	10	3	153
PMM1W6V8	6.46	6.8	7.14	37	3.5	10	4	140
PMM1W7V5	7.12	7.5	7.88	34	4.0	10	5	126
PMM1W8V2	7.79	8.2	8.61	31	4.5	10	6	116
PMM1W9V1	8.64	9.1	9.56	28	5.0	10	7	104
PMM1W10	9.50	10	10.5	25	7.0	10	7	95
PMM1W11	10.4	11	11.6	23	8.0	5	8	86
PMM1W12	11.4	12	12.6	21	9.0	5	9	79
PMM1W13	12.3	13	13.7	19	10	5	10	72
PMM1W15	14.2	15	15.8	17	14	5	11	63
PMM1W16	15.2	16	16.8	16	16	5	12	59
PMM1W18	17.1	18	18.9	14	20	5	13	52
PMM1W20	19.0	20	21.0	13	22	5	15	47
PMM1W22	20.9	22	23.1	12	23	5	17	43
PMM1W24	22.8	24	25.2	11	25	5	18	39
PMM1W27	25.6	27	28.4	9.5	35	5	21	35
PMM1W30	28.5	30	31.5	8.5	40	5	23	31
PMM1W33	31.3	33	34.7	7.5	45	5	25	28
PMM1W36	34.2	36	37.8	7.0	50	5	27	26
PMM1W39	37.0	39	41.0	6.5	60	5	30	24
PMM1W43	40.9	43	45.2	6.0	70	1	32	22
PMM1W47	44.7	47	49.4	5.5	80	1	35	20
PMM1W51	48.5	51	53.6	5.0	95	1	38	18
PMM1W56	53.2	56	58.8	4.5	110	1	42	17
PMM1W62	58.9	62	65.1	4.0	125	1	47	15
PMM1W68	64.6	68	71.4	3.7	150	1	52	14
PMM1W75	71.2	75	78.8	3.3	175	1	56	12
PMM1W82	77.9	82	86.1	3.0	200	1	62	11
PMM1W91	86.5	91	95.6	2.8	250	1	69	10
PMM1W100	95.0	100	105	2.5	350	1	76	9.5
PMM1W110	103	110	116	2.3	450	1	84	8.6
PMM1W120	114	120	127	2.0	550	1	91	7.8
PMM1W135	125	135	142	1.9	700	1	100	7.0

Type	Zener Voltage Range (1)			IZT	Dynamic Z _{ZT} (at I _{ZT})	Reverse Current		Admissible I _{ZM} (mA)
	VZT (at IZT)					I _R	at V _R	
	Min (V)	Nom (V)	Max (V)	(mA)	Max (Ω)			Max (μA)
PMM1W150	140	150	157	1.8	900	1	110	6.3
PMM1W165	155	165	172	1.6	1100	1	120	5.8
PMM1W180	170	180	191	1.4	1200	1	135	5.2
PMM1W200	189	200	211	1.2	1400	1	150	4.7
PMM1W220	209	220	231	1.0	1600	1	165	4.3
PMM1W240	229	240	251	1.0	1800	1	180	3.9
PMM1W260	249	260	271	1.0	2000	1	190	3.7
PMM1W280	269	280	291	1.0	2100	1	205	3.4
PMM1W300	289	300	315	1.0	2300	1	230	3.1
PMM1W330	313	330	346	1.0	2500	1	250	2.8

Product dimension (SOD-123FL)

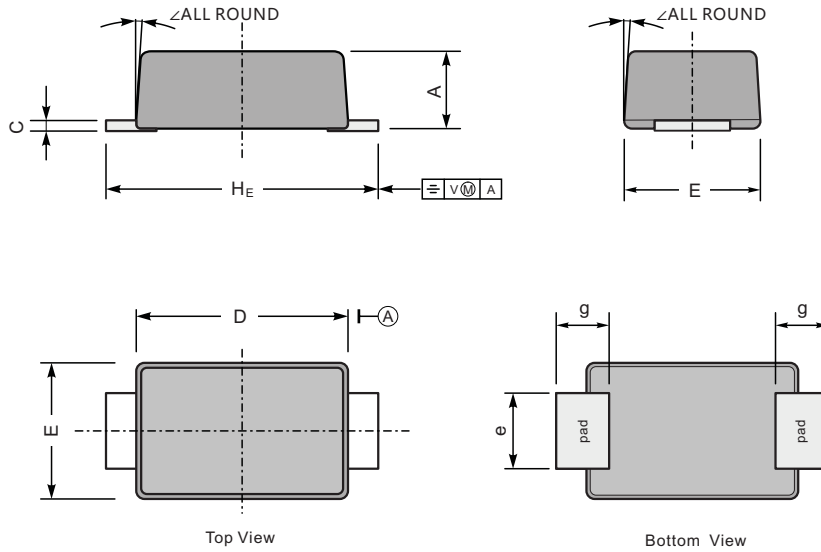

UNIT		A	C	D	E	e	g	H _E	z
mm	max	1.1	0.20	2.9	1.9	1.1	0.9	3.8	7°
	min	0.9	0.12	2.6	1.7	0.8	0.7	3.5	
mil	max	43	7.9	114	75	43	35	150	
	min	35	4.7	102	67	31	28	138	

The recommended mounting pad size

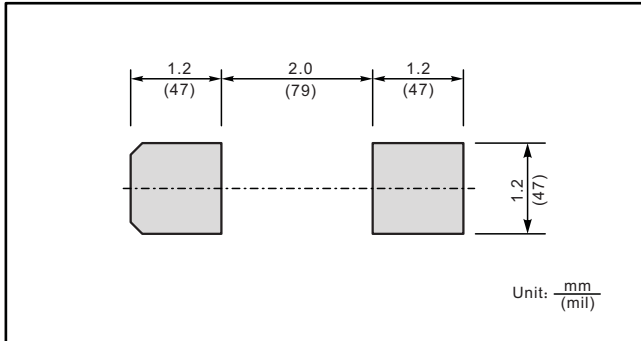

• Recommended condition of flow soldering

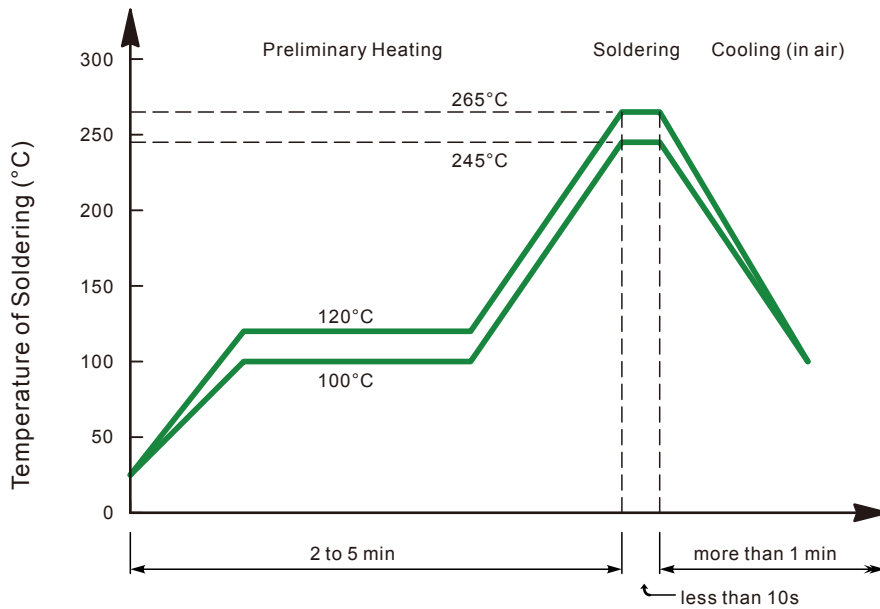

• Recommended condition of reflow soldering

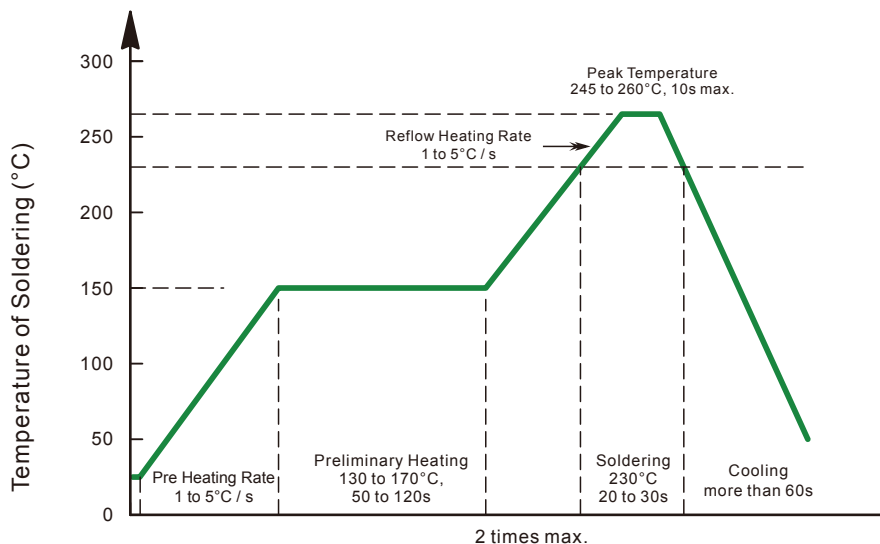

Recommended peak temperature is over 245 °C. If peak temperature is below 245 °C, you may adjust the following parameters; time length of peak temperature (longer), time length of soldering (longer), thickness of solder paste (thicker)

- **Condition of hand soldering**

Temperature: 370°C

Time: 3s max.

Times: one time

- **Remark:**

Lead free solder paste (96.5Sn/3.0Ag/0.5Cu)

IMPORTANT NOTICE

 and **Prisemi**[®] are registered trademarks of **Prisemi Electronics Co., Ltd (Prisemi)** ,Prisemi reserves the right to make changes without further notice to any products herein. Prisemi makes no warranty, representation or guarantee regarding the suitability of its products for any particular purpose, nor does Prisemi assume any liability arising out of the application or use of any product or circuit, and specifically disclaims any and all liability, including without limitation special, consequential or incidental damages. "Typical" parameters which may be provided in Prisemi data sheets and/or specifications can and do vary in different applications and actual performance may vary over time. All operating parameters, including "Typicals" must be validated for each customer application by customer's technical experts. Prisemi does not convey any license under its patent rights nor the rights of others. The products listed in this document are designed to be used with ordinary electronic equipment or devices, Should you intend to use these products with equipment or devices which require an extremely high level of reliability and the malfunction of with would directly endanger human life (such as medical instruments, aerospace machinery, nuclear-reactor controllers, fuel controllers and other safety devices), please be sure to consult with our sales representative in advance.

Website: <http://www.prisemi.com>

For additional information, please contact your local Sales Representative.

©Copyright 2009, Prisemi Electronics

 **Prisemi**[®] is a registered trademark of Prisemi Electronics.

All rights are reserved.