

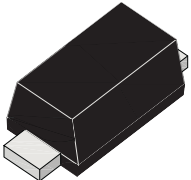



1 W Surface Mount Zener Diode

<p>SOD123W</p> 	<p>Voltage 11 to 220 V</p>	<p>Current 1 W</p>	
	<p>FEATURES</p> <ul style="list-style-type: none"> • Low profile package • Ideal for automated placement • Low leakage current • High surge current and zener capability • Low differential resistance • Tolerance series $\pm 5\%$ • Low forward voltage drop • Solder dip 260°C, 10s • AEC-Q101 qualified • Component in accordance to RoHS 2011/65/EU and WEEE 2002/96/EC • Meets MSL level 1, per J-STD-020, LF maximum peak of 260° C 		   RoHS COMPLIANT
	<p>MECHANICAL DATA</p> <ul style="list-style-type: none"> • Case: SOD123W. Epoxy meets UL 94V-0 flammability rating. • Polarity: Color band denotes cathode end. • Terminals: Matte tin plated leads, solderable per MIL-STD-750 Method 2026, J-STD-002 and JESD22-B102. Consumer grade, meets JESD 201 class 1A whisker test • HE3 suffix for high reliability grade, meets JESD 201 class 2 whisker test. 		
	<p>TYPICAL APPLICATIONS</p> <p>Used for basic regulation functions in most electronic applications, Zener diodes offer a cheaper alternative to IC solutions.</p>		

Maximum Ratings and Electrical Characteristics at 25 °C

SYMBOL	TYPE NUMBER	Value	Unit
V_F	Forward Voltage @ $I_F = 0.2A$	1.2	V
P_{tot}	Power Dissipation TL = 80 °C TA = 25 °C (Note 1)	2.3 1	W
P_{ZSM}	Non-Repetitive Peak Pulse Power Dissipation 100 μs square pulse (Note 2)	300	W
P_{RSM}	Non-Repetitive Peak Pulse Power Dissipation 10/1000 μs waveform (BZD27-C7V5W to BZD27-C100W) (Note 2)	150	W
P_{RSM}	Non-Repetitive Peak Pulse Power Dissipation 10/1000 μs waveform (BZD27-110W to BZD27-C220W) (Note 2)	100	W
R_{JA}	Thermal Resistance Junction to Ambient Air (Note 1)	180	°C/W
R_{JC}	Thermal Resistance Junction to lead	30	°C/W
$T_j - T_{stg}$	Operating and Storage Temperature Range	-65 to + 150	°C

Notes: 1. Mounted on Epoxy-Glass PCB with 3 x 3 mm Cu pads ($\geq 40 \mu m$ thick)
 2. $T_j = 25 \text{ °C}$ Prior to surge.

1 W Surface Mount Zener Diode

Ordering information

PREFERRED P/N	PACKAGE CODE	DELIVERY MODE	BASE QUANTITY	UNIT WEIGHT (g)
BZD27C11W TRTB	TRTB	13" diameter tape and reel	10,000	0.0165
BZD27C11W HE3 TRTB	TRTB	13" diameter tape and reel	10,000	0.0165

Package Outline Dimensions: (mm) SOD123W

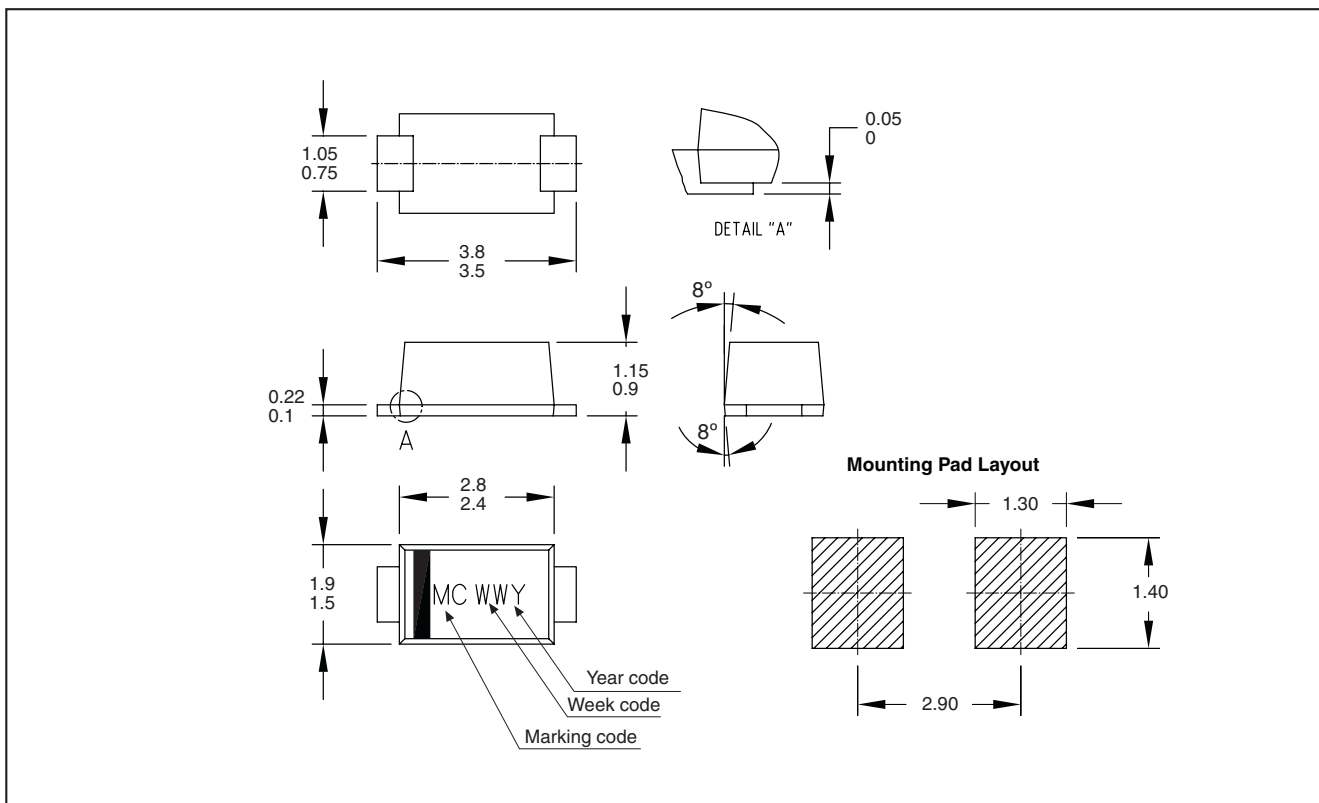

1 W Surface Mount Zener Diode
Ratings and Characteristics (Ta 25 °C unless otherwise noted)

Device	Device Marking Code	Working Voltage (Note 1)		Differential Resistance		Temperature Coefficient		Test Current	Reverse Current @ Reverse Voltage	
		$V_Z @ I_{ZT}$		$r_{dif} @ I_Z$		$ALPH_Z @ I_Z$			I_R	V_R
		V		Ω		% / °C		I_{ZT}	μA	V
		Min.	Max.	typ	Max.	Min.	Max.	mA	Max.	V
BZD27C11W	6A	10.4	11.6	4.0	7	0.05	0.10	50	4.0	8.2
BZD27C12W	6B	11.4	12.7	4.0	7	0.05	0.10	50	3.0	9.1
BZD27C13W	6C	12.4	14.1	5.0	10	0.05	0.10	50	2.0	10
BZD27C15W	6D	13.8	15.6	5.0	10	0.05	0.10	25	1.0	11
BZD27C16W	6E	15.3	17.1	6.0	15	0.06	0.11	25	1.0	12
BZD27C18W	6F	16.8	19.1	6.0	15	0.06	0.11	25	1.0	13
BZD27C24W	6G	22.8	25.6	7.0	15	0.06	0.11	25	1.0	18
BZD27C27W	6H	25.1	28.9	7.0	15	0.06	0.11	25	1.0	20
BZD27C30W	6I	28	32	8.0	15	0.06	0.11	25	1.0	22
BZD27C33W	6J	31	35	8.0	15	0.06	0.11	25	1.0	24
BZD27C36W	6K	34	38	21	40	0.06	0.11	10	1.0	27
BZD27C39W	6L	37	41	21	40	0.06	0.11	10	1.0	30
BZD27C43W	6M	40	46	24	45	0.07	0.12	10	1.0	33
BZD27C47W	6N	44	50	24	45	0.07	0.12	10	1.0	36
BZD27C51W	6O	48	54	25	45	0.07	0.12	10	1.0	39
BZD27C62W	6P	58	66	25	80	0.08	0.13	10	1.0	47
BZD27C68W	6Q	64	72	25	80	0.08	0.13	10	1.0	51
BZD27C75W	6R	70	79	30	100	0.08	0.13	10	1.0	56
BZD27C100W	6S	94	106	60	200	0.09	0.13	5	1.0	75
BZD27C110W	6Y	104	116	80	250	0.09	0.13	5	1.0	82
BZD27C120W	6T	114	127	150	300	0.09	0.13	5	1.0	91
BZD27C150W	6Z	138	156	150	300	0.09	0.13	5	1.0	110
BZD27C180W	6U	168	191	180	400	0.09	0.13	5	1.0	130
BZD27C200W	6V	188	212	350	750	0.09	0.13	5	1.0	150
BZD27C220W	6X	208	233	430	900	0.09	0.13	5	1.0	160

Notes: 1. Pulse test: $t_p \leq 5ms$.

- Electrical characteristics when used as voltage regulator diodes

1 W Surface Mount Zener Diode
Ratings and Characteristics (Ta 25 °C unless otherwise noted)

Device	Rev. Breakdown Voltage	Test Current	Temperature Coefficient		Clamping Voltage		Reverse Current@ Stand-Off Voltage	
	V(BR)@Itest	Itest	ALPHz@Itest		Vc	@IRSM (Note 1)	IR	@VWM
	V	mA	%°C		V	A	uA	V
	Min.		Min.	Max	Max.		Max.	
BZD27C11W	10.4	50	0.05	0.10	15.7	9.6	4.0	8.2
BZD27C12W	11.4	50	0.05	0.10	17	8.8	3.0	9.1
BZD27C13W	12.4	50	0.05	0.10	18.9	7.9	2.0	10
BZD27C15W	13.8	50	0.05	0.10	20.9	7.2	1.0	11
BZD27C16W	15.3	25	0.06	0.11	22.9	6.6	1.0	12
BZD27C18W	16.8	25	0.06	0.11	25.6	5.9	1.0	13
BZD27C24W	22.8	25	0.06	0.11	33.8	4.4	1.0	18
BZD27C27W	25.1	25	0.06	0.11	38.1	3.9	1.0	20
BZD27C30W	28	25	0.06	0.11	42.2	3.6	1.0	22
BZD27C33W	31	25	0.06	0.11	46.2	3.2	1.0	24
BZD27C36W	34	10	0.06	0.11	50.1	3	1.0	27
BZD27C39W	37	10	0.06	0.11	54.1	2.8	1.0	30
BZD27C43W	40	10	0.07	0.12	60.7	2.5	1.0	33
BZD27C47W	44	10	0.07	0.12	65.5	2.3	1.0	36
BZD27C51W	48	10	0.07	0.12	70.8	2.1	1.0	39
BZD27C62W	58	10	0.08	0.13	86.5	1.7	1.0	47
BZD27C68W	64	10	0.08	0.13	94.4	1.6	1.0	51
BZD27C75W	70	10	0.08	0.13	103.5	1.5	1.0	56
BZD27C100W	94	5	0.09	0.13	139	1.1	1.0	75
BZD27C110W	104	5	0.09	0.13	150	1	1.0	82
BZD27C120W	114	5	0.09	0.13	167	0.9	1.0	91
BZD27C150W	138	5	0.09	0.13	205	0.73	1.0	110
BZD27C180W	168	5	0.09	0.13	252	0.6	1.0	130
BZD27C200W	188	5	0.09	0.13	278	0.54	1.0	150
BZD27C220W	208	5	0.09	0.13	301	0.49	1.0	160

Notes: 1. Non-repetitive peak reverse current in accordance with "IEC 60-1, Section 8" (10/1000 µs pulse)

- Electrical characteristics when used as protection diodes

1 W Surface Mount Zener Diode

Ratings and Characteristics (Ta 25 °C unless otherwise noted)

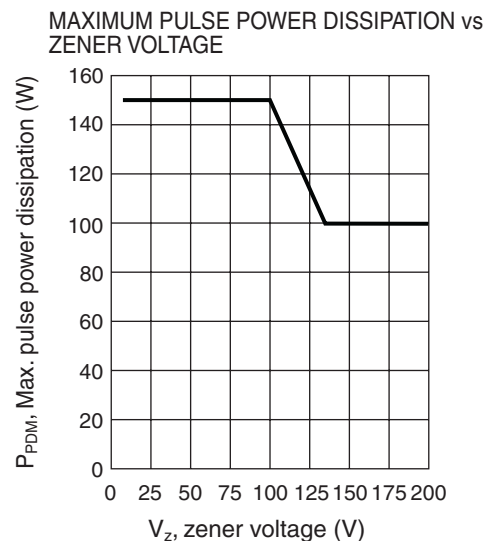
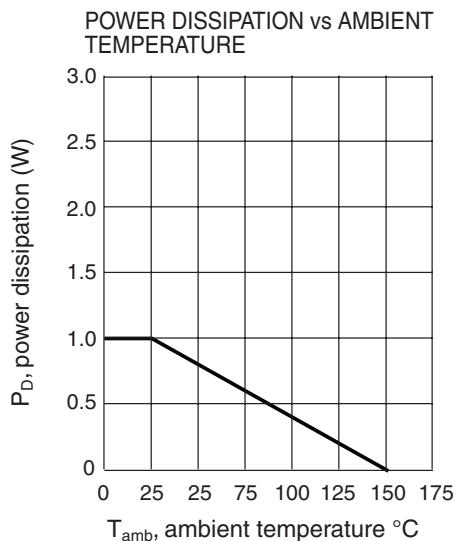
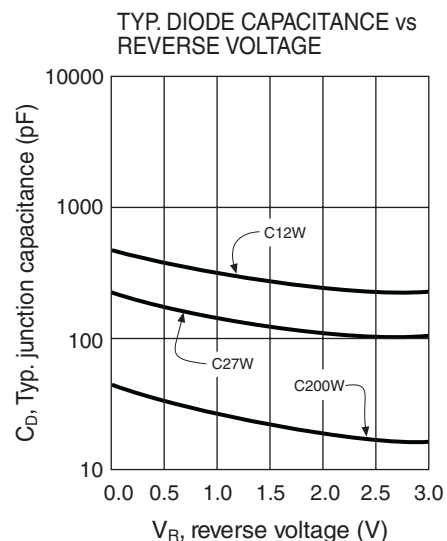
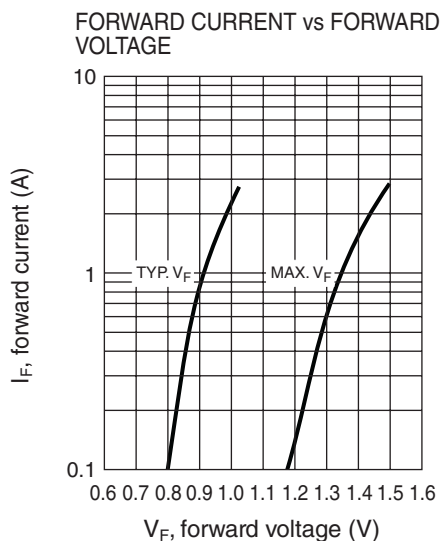

1 W Surface Mount Zener Diode**Revision History**

Date	Revision	Description of Changes
03-May-2013	0	Original Data Sheet
06-Feb-2014	1	Changed: Package Outline Dimensions, Add. BZD27C110W, Correct typing errors in electrical parameters
15-Oct-2014	2	Add. BZD27C150W

Disclaimer

All product, product specifications and data are subject to change without notice to improve reliability, function or design or otherwise.

Fagor Electrónica, S.Coop., its affiliates, agents, and employees, and all persons acting on its or their behalf (collectively, "Fagor"), disclaim any and all liability for any errors, inaccuracies or incompleteness contained in any datasheet or in any other disclosure relating to any product.

Fagor makes no warranty, representation or guarantee regarding the suitability of the products for any particular purpose or the continuing production of any product. To the maximum extent permitted by applicable law, Fagor disclaims (i) any and all liability arising out of the application or use of any product, (ii) any and all liability, including without limitation special, consequential or incidental damages, and (iii) any and all implied warranties, including warranties of fitness for particular purpose, non-infringement and merchantability.

Statements regarding the suitability of products for certain types of applications are based on Fagor's knowledge of typical requirements that are often placed on Fagor products in generic applications. Such statements are not binding statements about the suitability of products for a particular application. It is the customer's responsibility to validate that a particular product with the properties described in the product specification is suitable for use in a particular application. Parameters provided in datasheets and/or specifications may vary in different applications and performance may vary over time. All operating parameters, including typical parameters, must be validated for each customer application by the customer's technical experts. Product specifications do not expand or otherwise modify Fagor's terms and conditions of purchase, including but not limited to the warranty expressed therein.

Except as expressly indicated in writing, Fagor products are not designed for use in medical, life-saving, or life-sustaining applications or for any other application in which the failure of the Fagor product could result in personal injury or death. Customers using or selling Fagor products not expressly indicated for use in such applications do so at their own risk and agree to fully indemnify and hold Fagor and its distributors harmless from and against any and all claims, liabilities, expenses and damages arising or resulting in connection with such use or sale, including attorneys fees, even if such claim alleges that Fagor or its distributor was negligent regarding the design or manufacture of the part. Please contact authorized Fagor personnel to obtain written terms and conditions regarding products designed for such applications.

No license, express or implied, by estoppel or otherwise, to any intellectual property rights is granted by this document or by any conduct of Fagor, Product names and markings noted herein may be trademarks of their respective owners.