

MUN5311DW1T1G, SMUN5311DW1T1G, NSVMUN5311DW1T1G Series

Dual Bias Resistor Transistors

NPN and PNP Silicon Surface Mount Transistors with Monolithic Bias Resistor Network

The Bias Resistor Transistor (BRT) contains a single transistor with a monolithic bias network consisting of two resistors; a series base resistor and a base-emitter resistor. These digital transistors are designed to replace a single device and its external resistor bias network. The BRT eliminates these individual components by integrating them into a single device. In the MUN5311DW1T1G series, two complementary BRT devices are housed in the SOT-363 package which is ideal for low power surface mount applications where board space is at a premium.

Features

- Simplifies Circuit Design
- Reduces Board Space
- Reduces Component Count
- Available in 8 mm, 7 inch/3000 Unit Tape and Reel
- S and NSV Prefix for Automotive and Other Applications Requiring Unique Site and Control Change Requirements; AEC-Q101 Qualified and PPAP Capable
- These Devices are Pb-Free, Halogen Free/BFR Free and are RoHS Compliant*

MAXIMUM RATINGS ($T_A = 25^\circ\text{C}$ unless otherwise noted, common for Q_1 and Q_2 , - minus sign for Q_1 (PNP) omitted)

Rating	Symbol	Value	Unit
Collector-Base Voltage	V_{CBO}	50	Vdc
Collector-Emitter Voltage	V_{CEO}	50	Vdc
Collector Current	I_C	100	mAdc

Stresses exceeding Maximum Ratings may damage the device. Maximum Ratings are stress ratings only. Functional operation above the Recommended Operating Conditions is not implied. Extended exposure to stresses above the Recommended Operating Conditions may affect device reliability.

*For additional information on our Pb-Free strategy and soldering details, please download the ON Semiconductor Soldering and Mounting Techniques Reference Manual, SOLDERRM/D.



ON Semiconductor®

<http://onsemi.com>



SOT-363
CASE 419B
STYLE 1

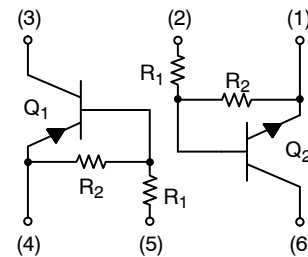

MARKING DIAGRAM

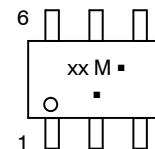

xx = Device Code
M = Date Code*
▪ = Pb-Free Package

(Note: Microdot may be in either location)

*Date Code orientation and/or position may vary depending upon manufacturing location.

ORDERING AND DEVICE MARKING INFORMATION

See detailed ordering, shipping, and specific marking information in the table on page 2 of this data sheet.

MUN5311DW1T1G, SMUN5311DW1T1G, NSVMUN5311DW1T1G Series

THERMAL CHARACTERISTICS

Characteristic (One Junction Heated)	Symbol	Max	Unit
Total Device Dissipation $T_A = 25^\circ\text{C}$ Derate above 25°C	P_D	187 (Note 1) 256 (Note 2) 1.5 (Note 1) 2.0 (Note 2)	mW mW/ $^\circ\text{C}$
Thermal Resistance – Junction-to-Ambient	$R_{\theta JA}$	670 (Note 1) 490 (Note 2)	$^\circ\text{C}/\text{W}$
Characteristic (Both Junctions Heated)	Symbol	Max	Unit
Total Device Dissipation $T_A = 25^\circ\text{C}$ Derate above 25°C	P_D	250 (Note 1) 385 (Note 2) 2.0 (Note 1) 3.0 (Note 2)	mW mW/ $^\circ\text{C}$
Thermal Resistance – Junction-to-Ambient	$R_{\theta JA}$	493 (Note 1) 325 (Note 2)	$^\circ\text{C}/\text{W}$
Thermal Resistance – Junction-to-Lead	$R_{\theta JL}$	188 (Note 1) 208 (Note 2)	$^\circ\text{C}/\text{W}$
Junction and Storage Temperature	T_J, T_{stg}	-55 to +150	$^\circ\text{C}$

- FR-4 @ Minimum Pad
- FR-4 @ 1.0 x 1.0 inch Pad

ORDERING, SHIPPING, DEVICE MARKING AND RESISTOR VALUES

Device	Package	Marking	R1 (K)	R2 (K)	Shipping [†]
MUN5311DW1T1G, SMUN5311DW1T1G, SMUN5311DW1T2G	SOT-363 (Pb-Free)	11	10	10	3,000 / Tape & Reel
MUN5312DW1T1G, SMUN5312DW1T1G	SOT-363 (Pb-Free)	12	22	22	3,000 / Tape & Reel
MUN5313DW1T1G, SMUN5313DW1T1G	SOT-363 (Pb-Free)	13	47	47	3,000 / Tape & Reel
MUN5314DW1T1G, SMUN5314DW1T1G	SOT-363 (Pb-Free)	14	10	47	3,000 / Tape & Reel
MUN5315DW1T1G, SMUN5315DW1T1G	SOT-363 (Pb-Free)	15	10	∞	3,000 / Tape & Reel
MUN5316DW1T1G	SOT-363 (Pb-Free)	16	4.7	∞	3,000 / Tape & Reel
MUN5330DW1T1G, SMUN5330DW1T1G	SOT-363 (Pb-Free)	30	1.0	1.0	3,000 / Tape & Reel
MUN5331DW1T1G	SOT-363 (Pb-Free)	31	2.2	2.2	3,000 / Tape & Reel
MUN5332DW1T1G, NSVMUN5332DW1T1G	SOT-363 (Pb-Free)	32	4.7	4.7	3,000 / Tape & Reel
MUN5333DW1T1G, NSVMUN5333DW1T1G	SOT-363 (Pb-Free)	33	4.7	47	3,000 / Tape & Reel
MUN5334DW1T1G, NSVMUN5334DW1T1G	SOT-363 (Pb-Free)	34	22	47	3,000 / Tape & Reel
MUN5335DW1T1G, SMUN5335DW1T1G, SMUN5335DW1T2G	SOT-363 (Pb-Free)	35	2.2	47	3,000 / Tape & Reel

[†]For information on tape and reel specifications, including part orientation and tape sizes, please refer to our Tape and Reel Packaging Specifications Brochure, BRD8011/D.

MUN5311DW1T1G, SMUN5311DW1T1G, NSVMUN5311DW1T1G Series

ELECTRICAL CHARACTERISTICS

(T_A = 25°C unless otherwise noted, common for Q₁ and Q₂, – minus sign for Q₁ (PNP) omitted)

Characteristic	Symbol	Min	Typ	Max	Unit
OFF CHARACTERISTICS					
Collector-Base Cutoff Current (V _{CB} = 50 V, I _E = 0)	I _{CBO}	–	–	100	nAdc
Collector-Emitter Cutoff Current (V _{CE} = 50 V, I _B = 0)	I _{CEO}	–	–	500	nAdc
Emitter-Base Cutoff Current (V _{EB} = 6.0 V, I _C = 0)	I _{EBO}				mAdc
MUN5311DW1T1G, SMUN5311DW1T1G		–	–	0.5	
MUN5312DW1T1G, SMUN5312DW1T1G		–	–	0.2	
MUN5313DW1T1G, SMUN5313DW1T1G		–	–	0.1	
MUN5314DW1T1G, SMUN5314DW1T1G		–	–	0.2	
MUN5315DW1T1G, SMUN5315DW1T1G		–	–	0.9	
MUN5316DW1T1G		–	–	1.9	
MUN5330DW1T1G, SMUN5330DW1T1G		–	–	4.3	
MUN5331DW1T1G		–	–	2.3	
MUN5332DW1T1G, NSVMUN5332DW1T1G		–	–	1.5	
MUN5333DW1T1G, NSVMUN5333DW1T1G		–	–	0.18	
MUN5334DW1T1G, NSVMUN5334DW1T1G		–	–	0.13	
MUN5335DW1T1G, SMUN5335DW1T1G		–	–	0.2	
Collector-Base Breakdown Voltage (I _C = 10 μA, I _E = 0)	V _{(BR)CBO}	50	–	–	Vdc
Collector-Emitter Breakdown Voltage (Note 3) (I _C = 2.0 mA, I _B = 0)	V _{(BR)CEO}	50	–	–	Vdc

ON CHARACTERISTICS (Note 3)

DC Current Gain (V _{CE} = 10 V, I _C = 5.0 mA)	h _{FE}				
MUN5311DW1T1G, SMUN5311DW1T1G		35	60	–	
MUN5312DW1T1G, SMUN5312DW1T1G		60	100	–	
MUN5313DW1T1G, SMUN5313DW1T1G		80	140	–	
MUN5314DW1T1G, SMUN5314DW1T1G		80	140	–	
MUN5315DW1T1G, SMUN5315DW1T1G		160	350	–	
MUN5316DW1T1G		160	350	–	
MUN5330DW1T1G, SMUN5330DW1T1G		3.0	5.0	–	
MUN5331DW1T1G		8.0	15	–	
MUN5332DW1T1G, NSVMUN5332DW1T1G		15	30	–	
MUN5333DW1T1G, NSVMUN5333DW1T1G		80	200	–	
MUN5334DW1T1G, NSVMUN5334DW1T1G		80	150	–	
MUN5335DW1T1G, SMUN5335DW1T1G		80	140	–	
Collector-Emitter Saturation Voltage (I _C = 10 mA, I _B = 0.3 mA)	V _{CE(sat)}				Vdc
MUN5311DW1T1G, SMUN5311DW1T1G		–	–	0.25	
MUN5312DW1T1G, SMUN5312DW1T1G		–	–	0.25	
MUN5313DW1T1G, SMUN5313DW1T1G		–	–	0.25	
MUN5314DW1T1G, SMUN5314DW1T1G		–	–	0.25	
MUN5335DW1T1G, SMUN5335DW1T1G		–	–	0.25	
(I _C = 10 mA, I _B = 5 mA)					
MUN5330DW1T1G, SMUN5330DW1T1G		–	–	0.25	
MUN5331DW1T1G		–	–	0.25	
(I _C = 10 mA, I _B = 1 mA)					
MUN5315DW1T1G, SMUN5315DW1T1G		–	–	0.25	
MUN5316DW1T1G		–	–	0.25	
MUN5332DW1T1G, NSVMUN5332DW1T1G		–	–	0.25	
MUN5333DW1T1G, NSVMUN5333DW1T1G		–	–	0.25	
MUN5334DW1T1G, NSVMUN5334DW1T1G		–	–	0.25	

MUN5311DW1T1G, SMUN5311DW1T1G, NSVMUN5311DW1T1G Series

Characteristic	Symbol	Min	Typ	Max	Unit
ON CHARACTERISTICS (Note 3)					
Output Voltage (on) ($V_{CC} = 5.0\text{ V}$, $V_B = 2.5\text{ V}$, $R_L = 1.0\text{ k}\Omega$) MUN5311DW1T1G, SMUN5311DW1T1G MUN5312DW1T1G, SMUN5312DW1T1G MUN5314DW1T1G, SMUN5314DW1T1G MUN5315DW1T1G, SMUN5315DW1T1G MUN5316DW1T1G MUN5330DW1T1G, SMUN5330DW1T1G MUN5331DW1T1G MUN5332DW1T1G, NSVMUN5332DW1T1G MUN5333DW1T1G, NSVMUN5333DW1T1G MUN5334DW1T1G, NSVMUN5334DW1T1G MUN5335DW1T1G, SMUN5335DW1T1G ($V_{CC} = 5.0\text{ V}$, $V_B = 3.5\text{ V}$, $R_L = 1.0\text{ k}\Omega$) MUN5313DW1T1G, SMUN5313DW1T1G	V_{OL}	-	-	0.2	Vdc
Output Voltage (off) ($V_{CC} = 5.0\text{ V}$, $V_B = 0.5\text{ V}$, $R_L = 1.0\text{ k}\Omega$) MUN5311DW1T1G, SMUN5311DW1T1G MUN5312DW1T1G, SMUN5312DW1T1G MUN5313DW1T1G, SMUN5313DW1T1G MUN5314DW1T1G, SMUN5314DW1T1G MUN5333DW1T1G, NSVMUN5333DW1T1G MUN5334DW1T1G, NSVMUN5334DW1T1G MUN5335DW1T1G, SMUN5335DW1T1G ($V_{CC} = 5.0\text{ V}$, $V_B = 0.050\text{ V}$, $R_L = 1.0\text{ k}\Omega$) MUN5330DW1T1G, SMUN5330DW1T1G ($V_{CC} = 5.0\text{ V}$, $V_B = 0.25\text{ V}$, $R_L = 1.0\text{ k}\Omega$) MUN5315DW1T1G, SMUN5315DW1T1G MUN5316DW1T1G MUN5331DW1T1G MUN5332DW1T1G, NSVMUN5332DW1T1G	V_{OH}	4.9	-	-	Vdc
Input Resistor MUN5311DW1T1G, SMUN5311DW1T1G MUN5312DW1T1G, SMUN5312DW1T1G MUN5313DW1T1G, SMUN5313DW1T1G MUN5314DW1T1G, SMUN5314DW1T1G MUN5315DW1T1G, SMUN5315DW1T1G MUN5316DW1T1G MUN5330DW1T1G, SMUN5330DW1T1G MUN5331DW1T1G MUN5332DW1T1G, NSVMUN5332DW1T1G MUN5333DW1T1G, NSVMUN5333DW1T1G MUN5334DW1T1G, NSVMUN5334DW1T1G MUN5335DW1T1G, SMUN5335DW1T1G	R1	7.0	10	13	k Ω
Resistor Ratio MUN5311DW1T1G/SMUN5311DW1T1G/MUN5312DW1T1G/ SMUN5312DW1T1G/MUN5313DW1T1G/SMUN5313DW1T1G MUN5314DW1T1G/SMUN5314DW1T1G MUN5315DW1T1G/SMUN5315DW1T1G/MUN5316DW1T1G MUN5330DW1T1G/SMUN5330DW1T1G/MUN5331DW1T1G/ MUN5332DW1T1G/NSVMUN5332DW1T1G MUN5333DW1T1G/NSVMUN5333DW1T1G MUN5334DW1T1G/NSVMUN5334DW1T1G MUN5335DW1T1G/SMUN5335DW1T1G	R1/R2	0.8	1.0	1.2	
		0.17	0.21	0.25	
		-	-	-	
		0.8	1.0	1.2	
		0.055	0.1	0.185	
		0.38	0.47	0.56	
		0.038	0.047	0.056	

3. Pulse Test: Pulse Width < 300 μs , Duty Cycle < 2.0%

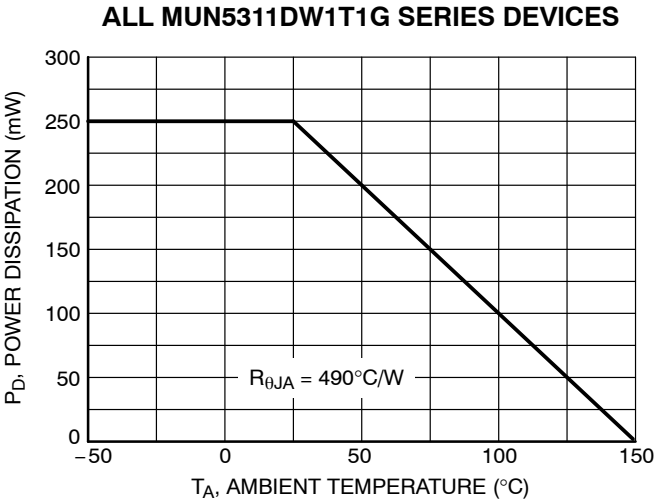

Figure 1. Derating Curve

MUN5311DW1T1G, SMUN5311DW1T1G, NSVMUN5311DW1T1G Series

TYPICAL ELECTRICAL CHARACTERISTICS – MUN5311DW1T1G, SMUN5311DW1T1G
NPN TRANSISTOR

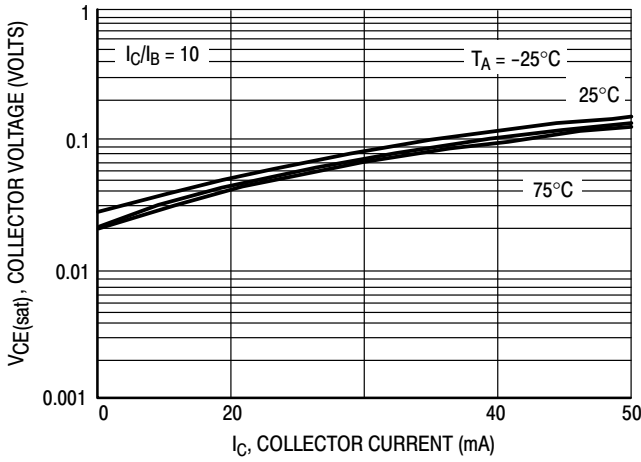

Figure 2. $V_{CE(sat)}$ versus I_C

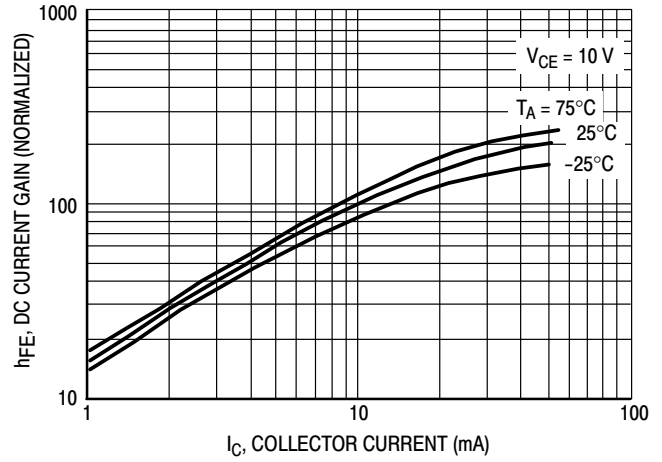

Figure 3. DC Current Gain

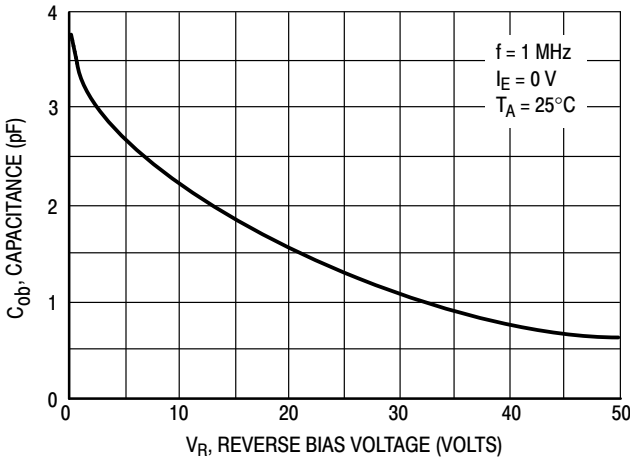

Figure 4. Output Capacitance

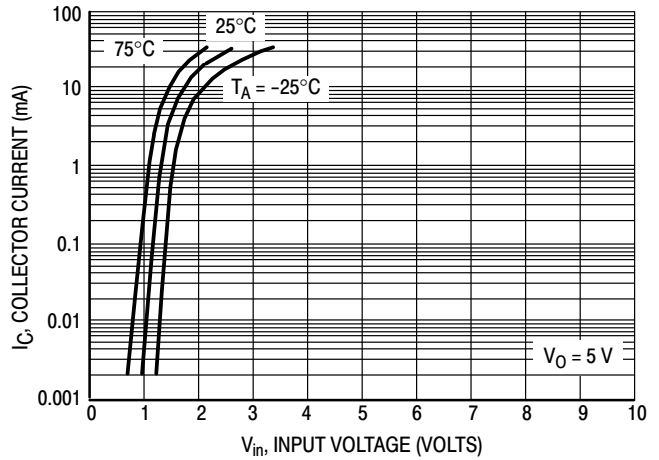

Figure 5. Output Current versus Input Voltage

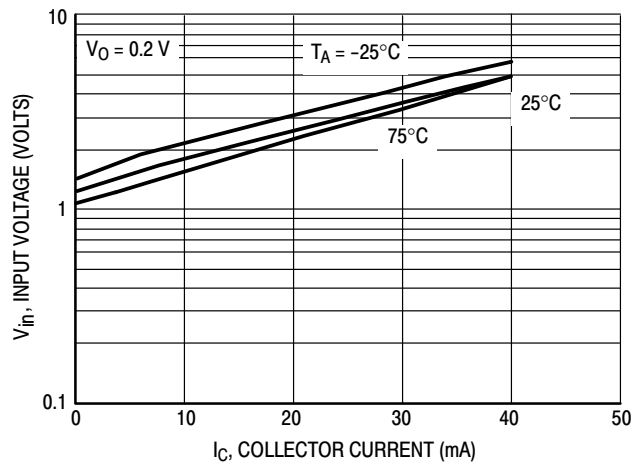

Figure 6. Input Voltage versus Output Current

MUN5311DW1T1G, SMUN5311DW1T1G, NSVMUN5311DW1T1G Series

TYPICAL ELECTRICAL CHARACTERISTICS – MUN5311DW1T1G, SMUN5311DW1T1G PNP TRANSISTOR

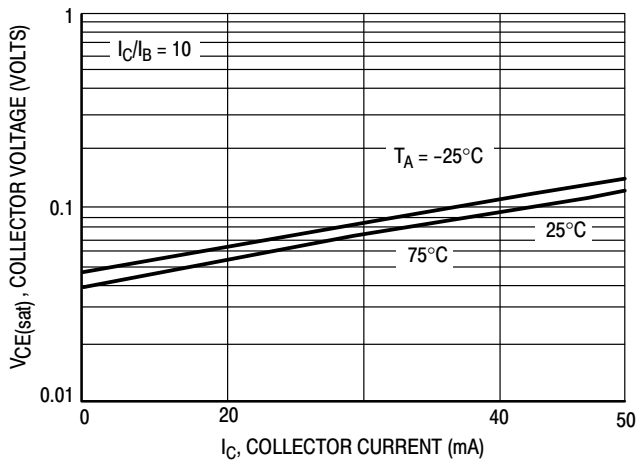

Figure 7. $V_{CE(sat)}$ versus I_C

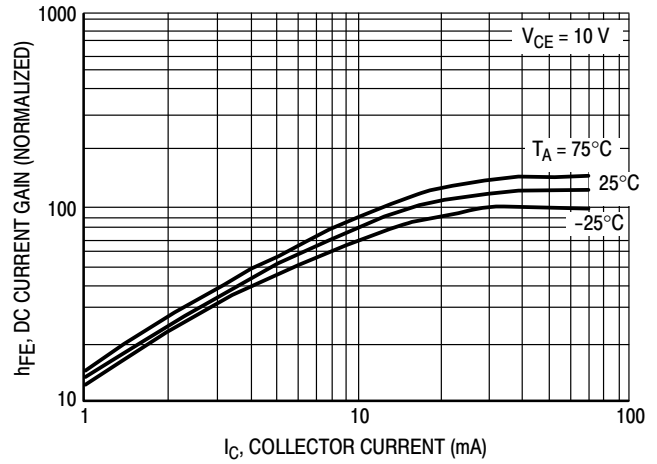

Figure 8. DC Current Gain

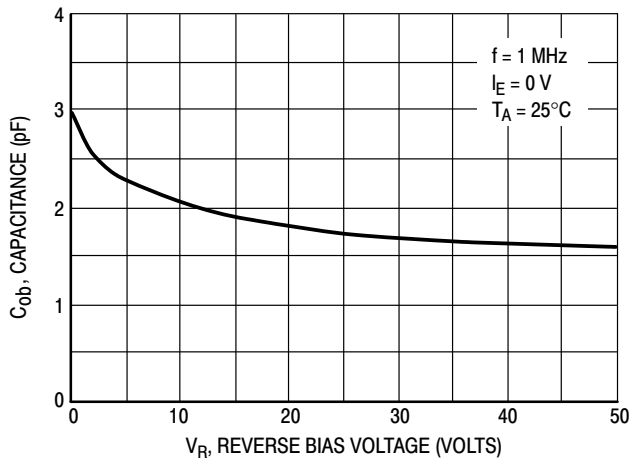

Figure 9. Output Capacitance

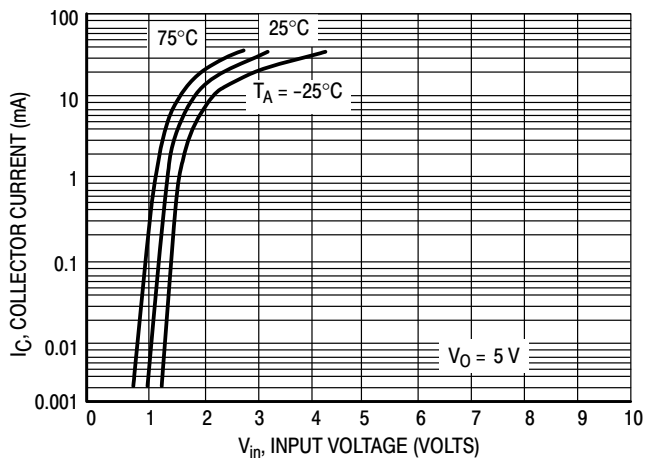

Figure 10. Output Current versus Input Voltage

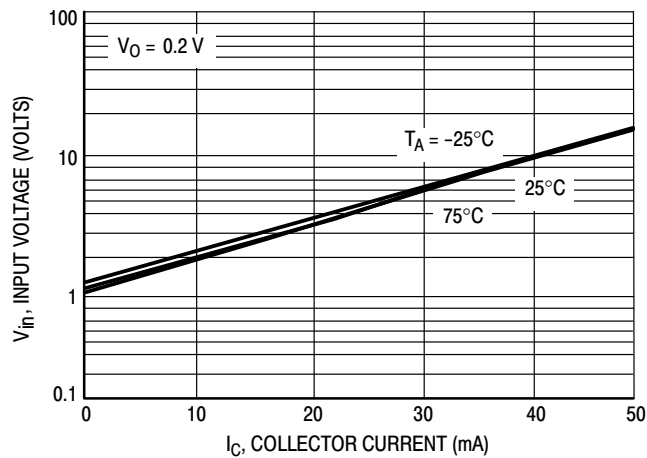

Figure 11. Input Voltage versus Output Current

MUN5311DW1T1G, SMUN5311DW1T1G, NSVMUN5311DW1T1G Series

TYPICAL ELECTRICAL CHARACTERISTICS – MUN5312DW1T1G, SMUN5312DW1T1G
NPN TRANSISTOR

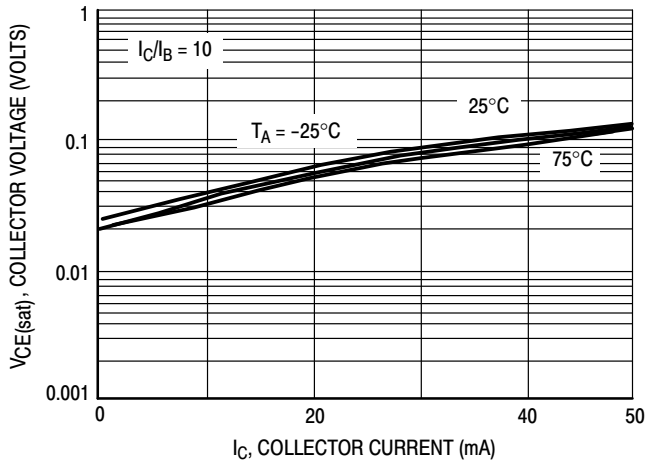

Figure 12. $V_{CE(sat)}$ versus I_C

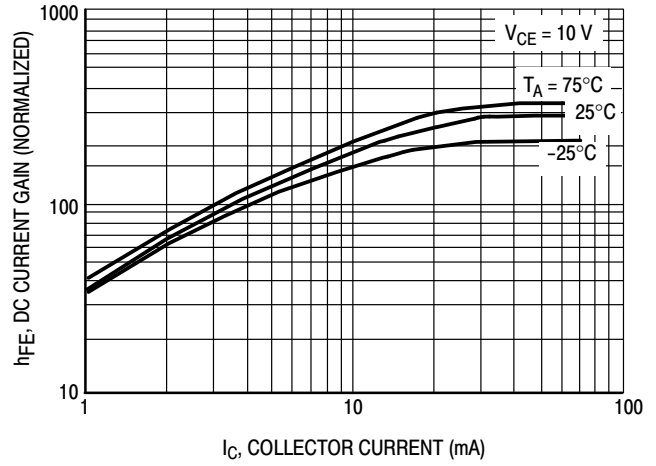

Figure 13. DC Current Gain

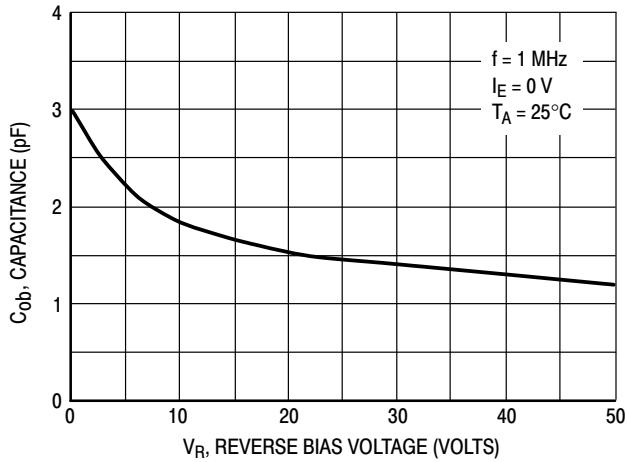

Figure 14. Output Capacitance

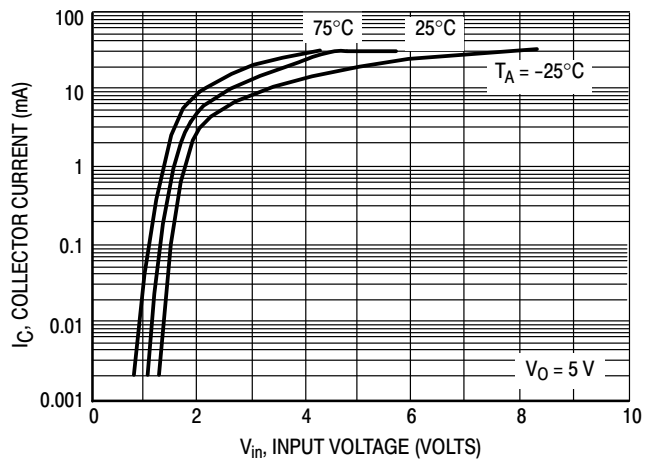

Figure 15. Output Current versus Input Voltage

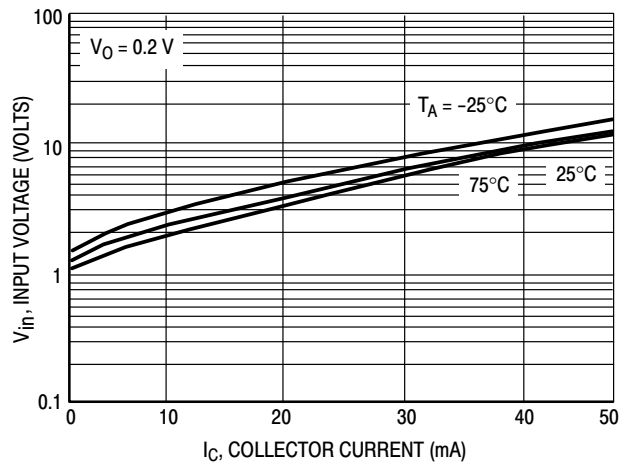

Figure 16. Input Voltage versus Output Current

MUN5311DW1T1G, SMUN5311DW1T1G, NSVMUN5311DW1T1G Series

TYPICAL ELECTRICAL CHARACTERISTICS – MUN5312DW1T1G, SMUN5312DW1T1G
PNP TRANSISTOR

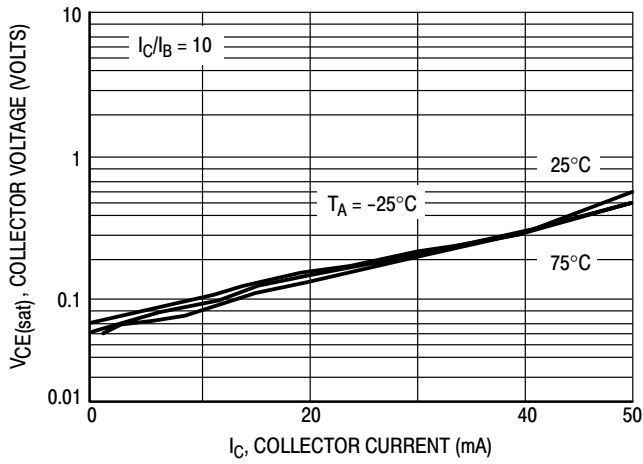

Figure 17. $V_{CE(sat)}$ versus I_C

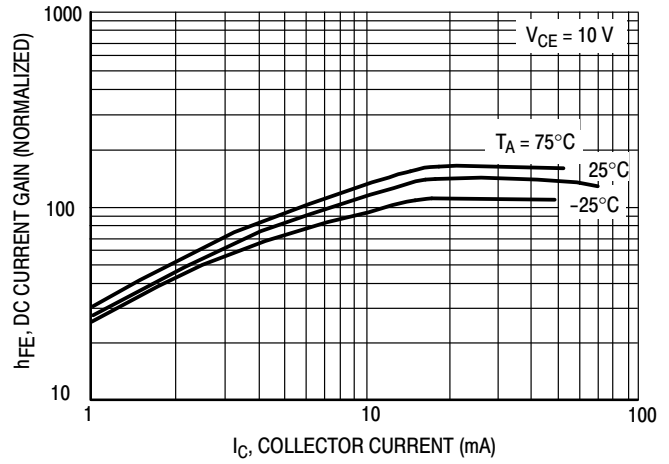

Figure 18. DC Current Gain

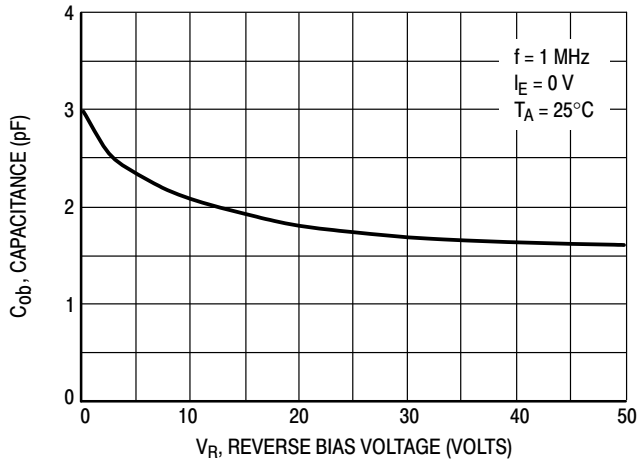

Figure 19. Output Capacitance

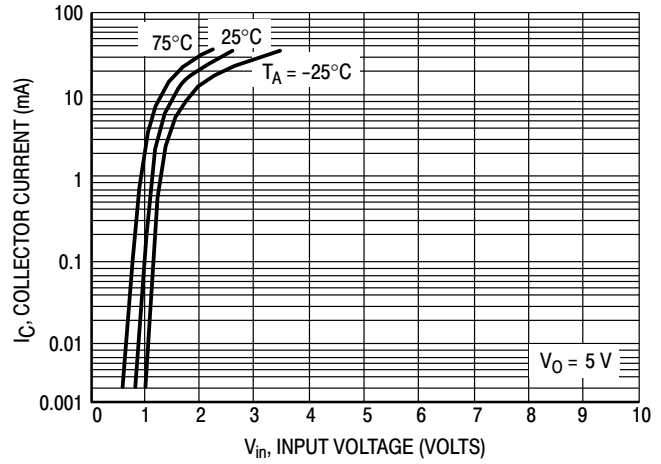

Figure 20. Output Current versus Input Voltage

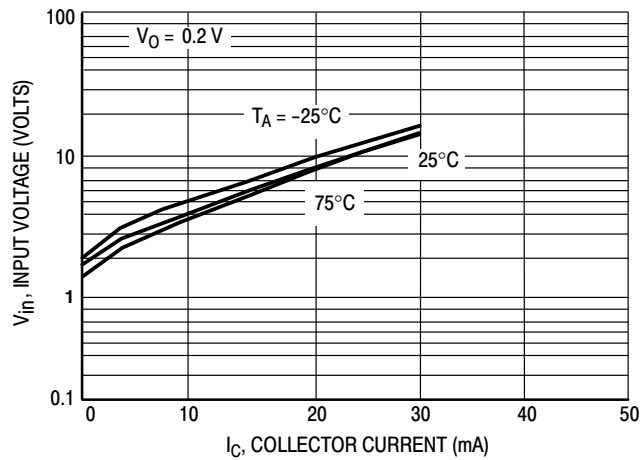

Figure 21. Input Voltage versus Output Current

MUN5311DW1T1G, SMUN5311DW1T1G, NSVMUN5311DW1T1G Series

TYPICAL ELECTRICAL CHARACTERISTICS – MUN5313DW1T1G, SMUN5313DW1T1G NPN TRANSISTOR

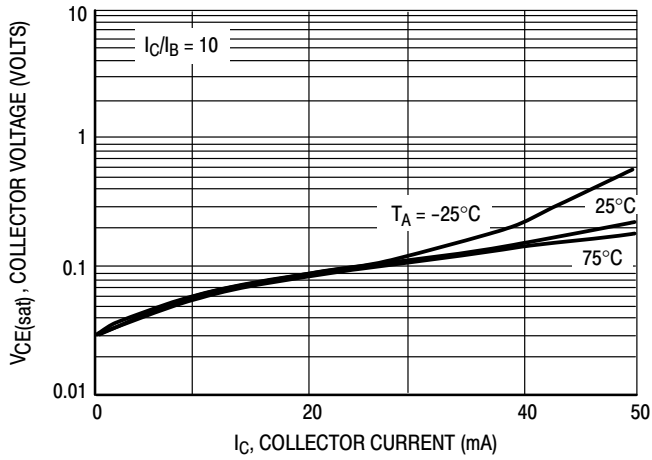

Figure 22. $V_{CE(sat)}$ versus I_C

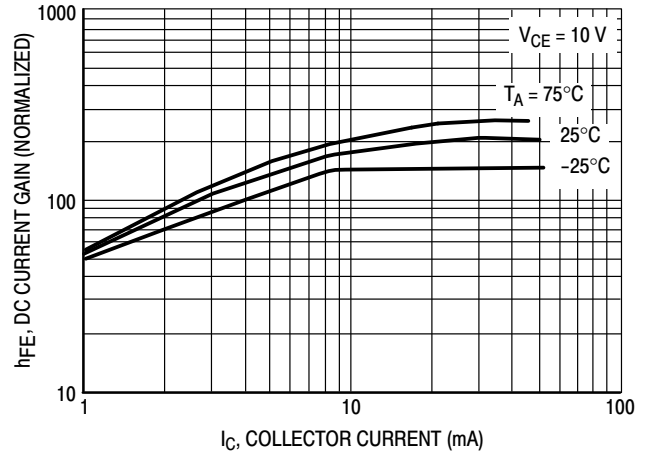

Figure 23. DC Current Gain

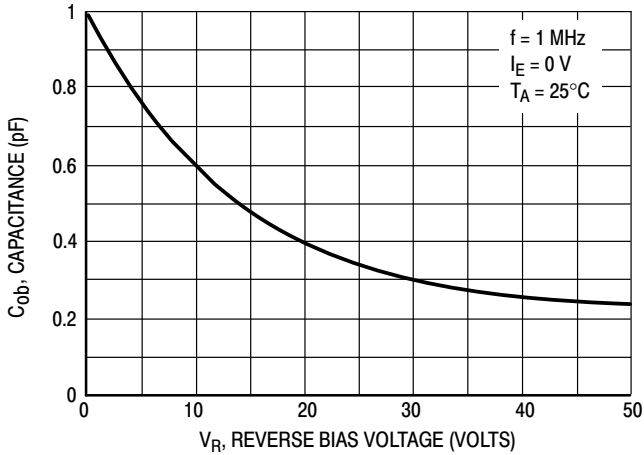

Figure 24. Output Capacitance

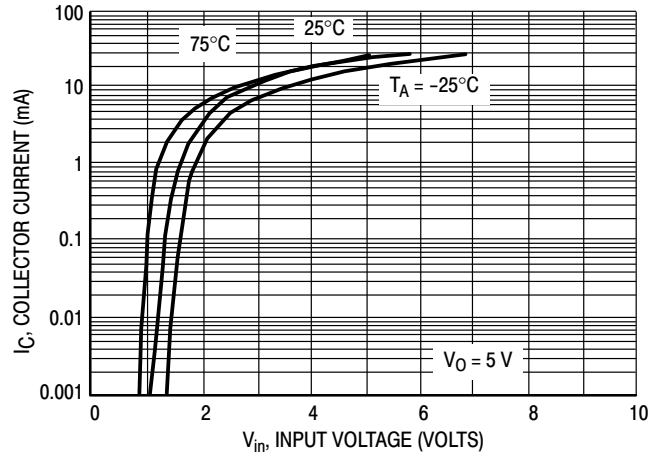

Figure 25. Output Current versus Input Voltage

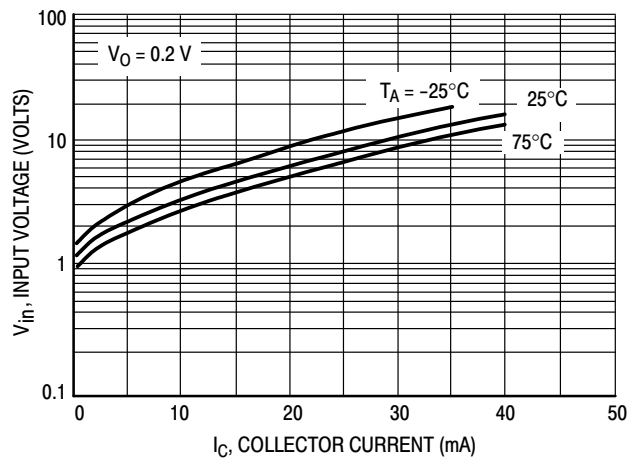

Figure 26. Input Voltage versus Output Current

MUN5311DW1T1G, SMUN5311DW1T1G, NSVMUN5311DW1T1G Series

TYPICAL ELECTRICAL CHARACTERISTICS – MUN5313DW1T1G, SMUN5313DW1T1G
PNP TRANSISTOR

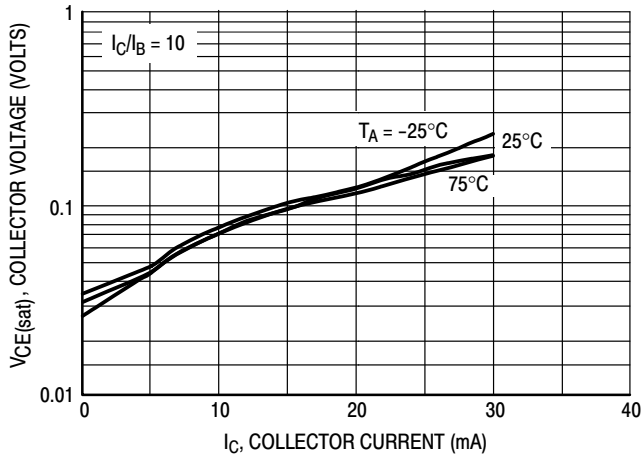

Figure 27. $V_{CE(sat)}$ versus I_C

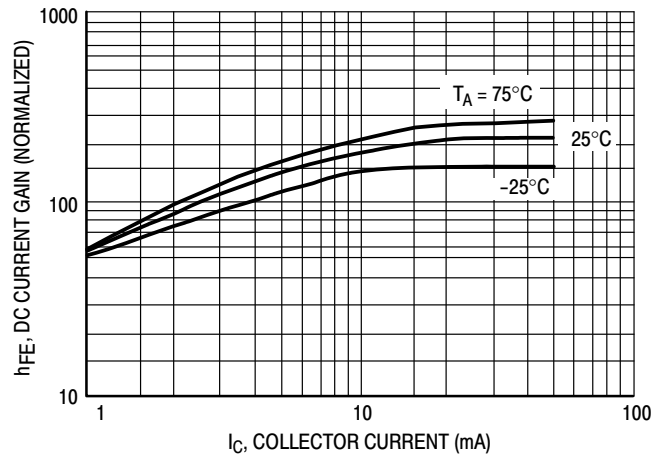

Figure 28. DC Current Gain

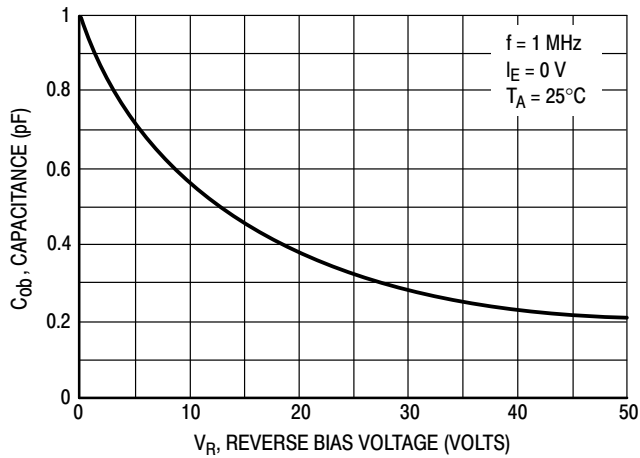

Figure 29. Output Capacitance

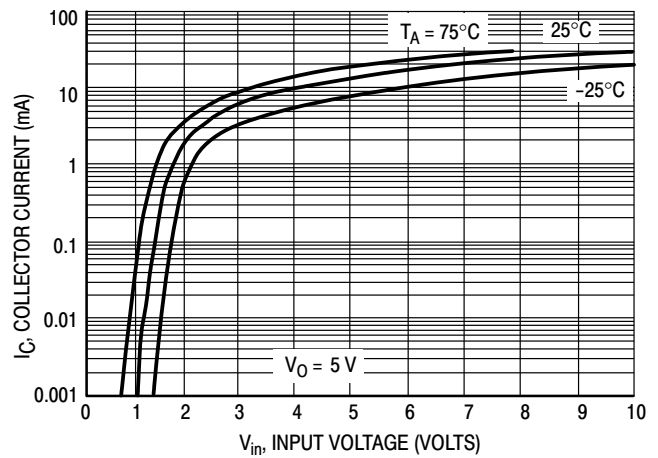

Figure 30. Output Current versus Input Voltage

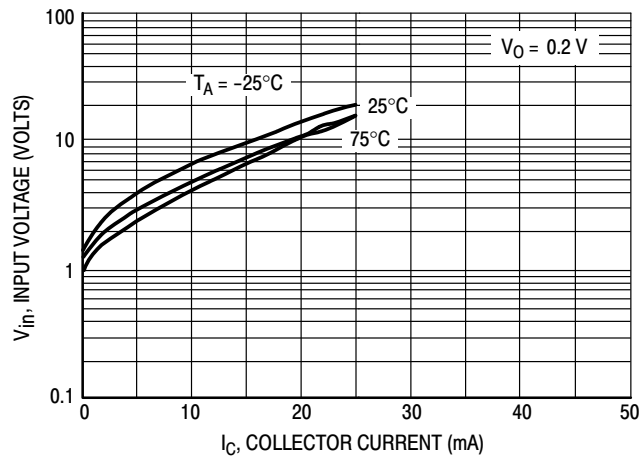

Figure 31. Input Voltage versus Output Current

MUN5311DW1T1G, SMUN5311DW1T1G, NSVMUN5311DW1T1G Series

TYPICAL ELECTRICAL CHARACTERISTICS – MUN5314DW1T1G, SMUN5314DW1T1G
NPN TRANSISTOR

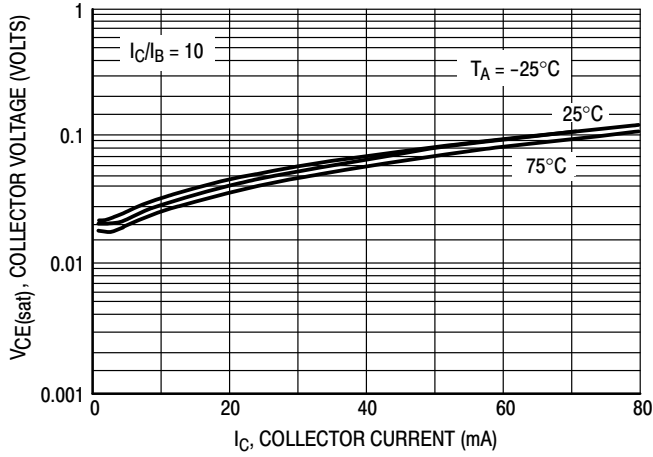

Figure 32. $V_{CE(sat)}$ versus I_C

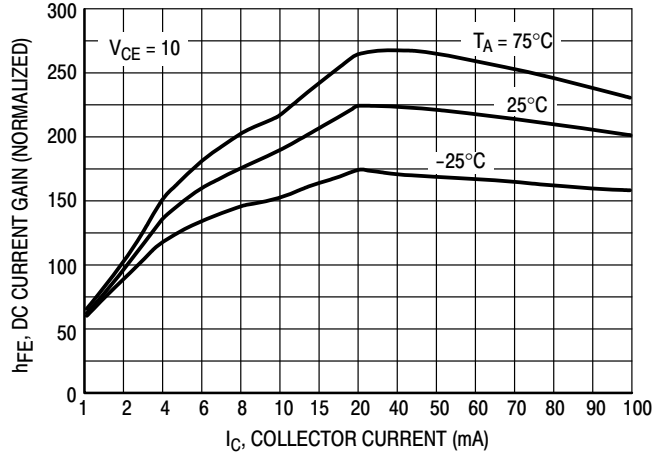

Figure 33. DC Current Gain

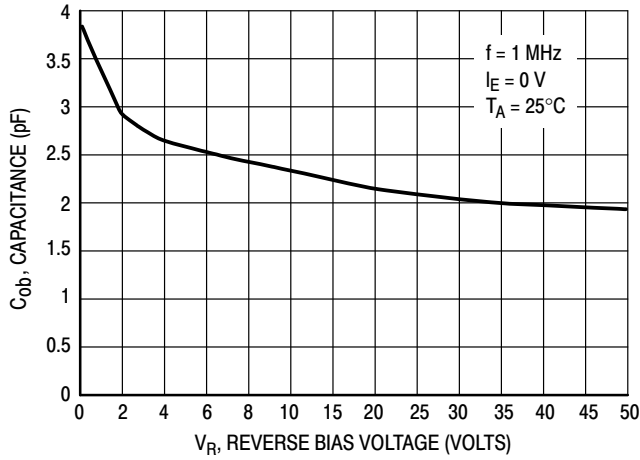

Figure 34. Output Capacitance

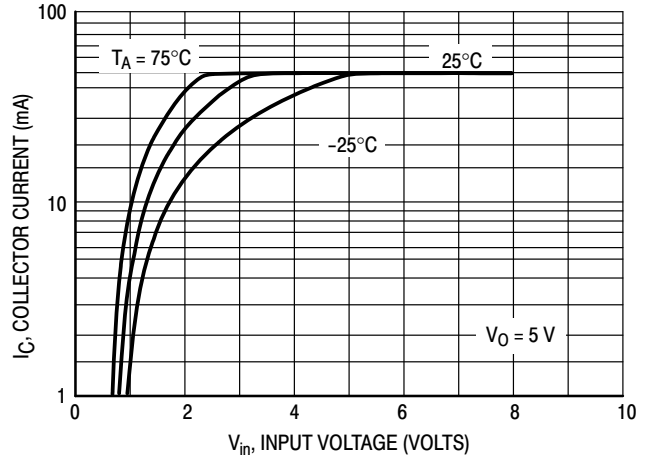

Figure 35. Output Current versus Input Voltage

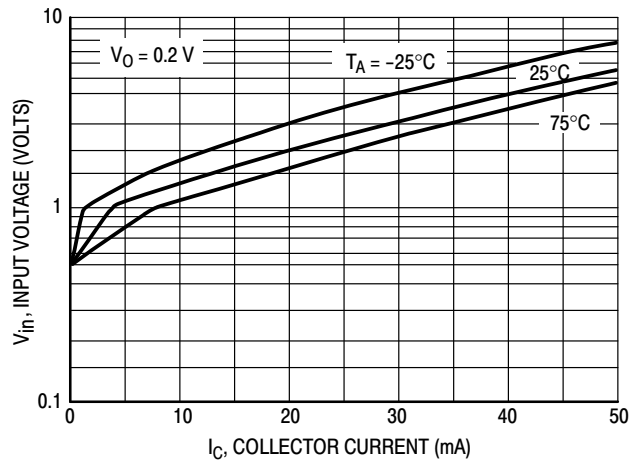

Figure 36. Input Voltage versus Output Current

MUN5311DW1T1G, SMUN5311DW1T1G, NSVMUN5311DW1T1G Series

TYPICAL ELECTRICAL CHARACTERISTICS – MUN5314DW1T1G, SMUN5314DW1T1G
PNP TRANSISTOR

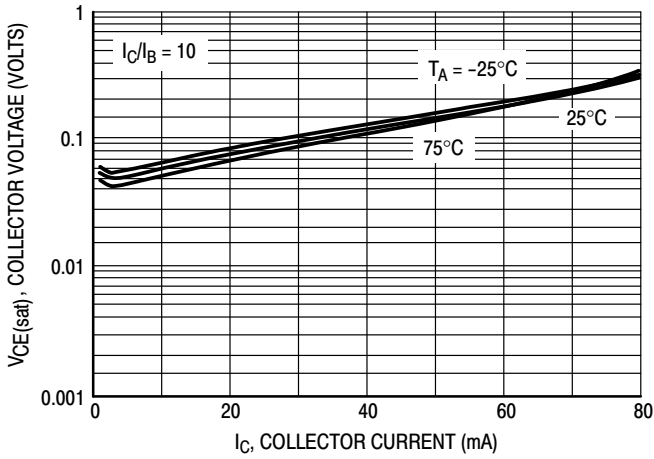

Figure 37. $V_{CE(sat)}$ versus I_C

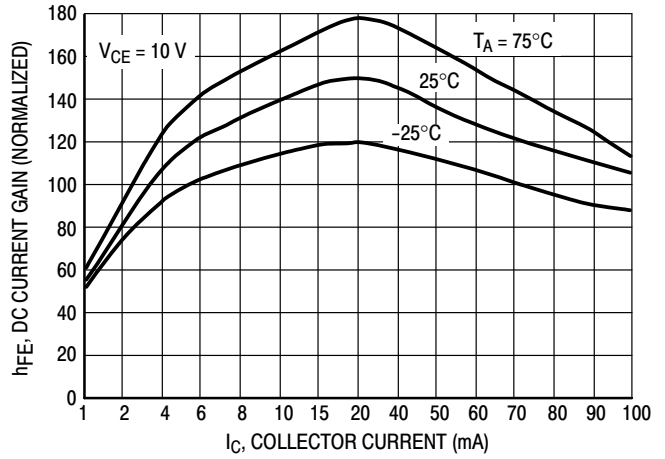

Figure 38. DC Current Gain

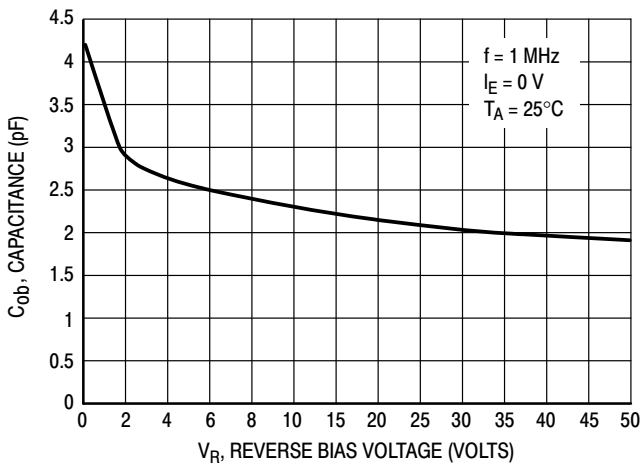

Figure 39. Output Capacitance

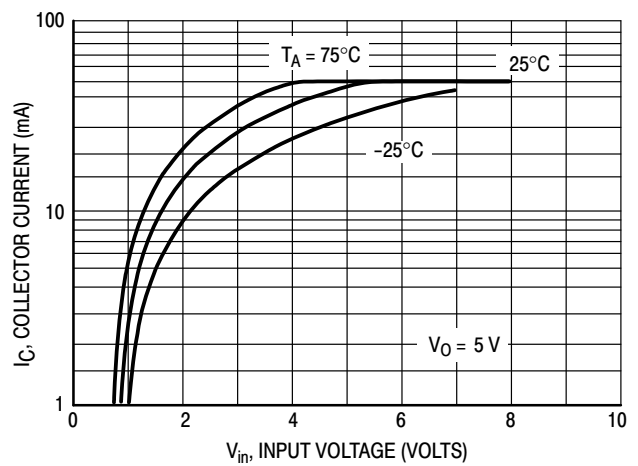

Figure 40. Output Current versus Input Voltage

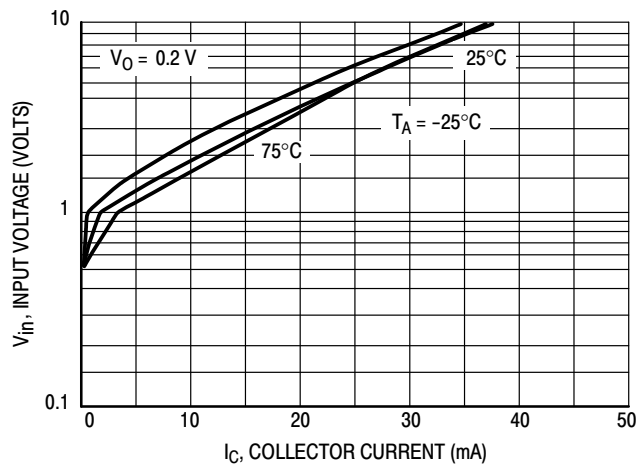

Figure 41. Input Voltage versus Output Current

MUN5311DW1T1G, SMUN5311DW1T1G, NSVMUN5311DW1T1G Series

TYPICAL ELECTRICAL CHARACTERISTICS — MUN5315DW1T1G, SMUN5315DW1T1G
NPN TRANSISTOR

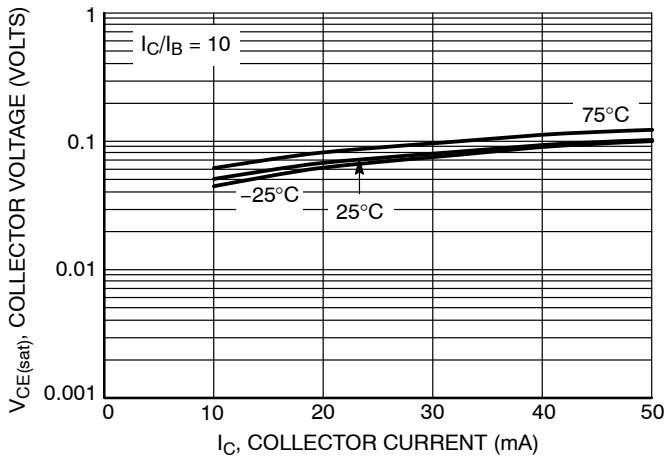

Figure 42. $V_{CE(sat)}$ versus I_C

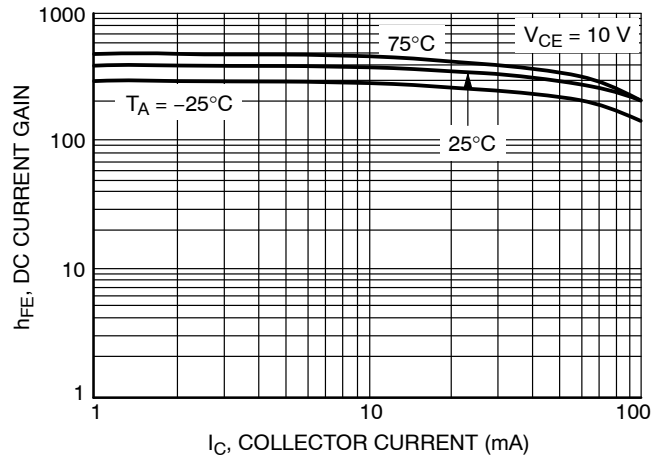

Figure 43. DC Current Gain

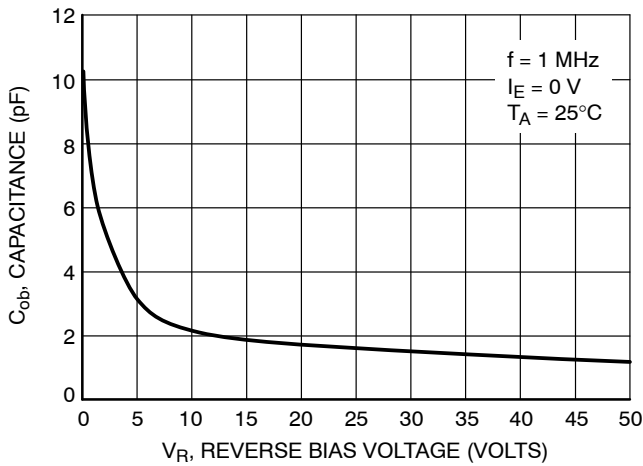

Figure 44. Output Capacitance

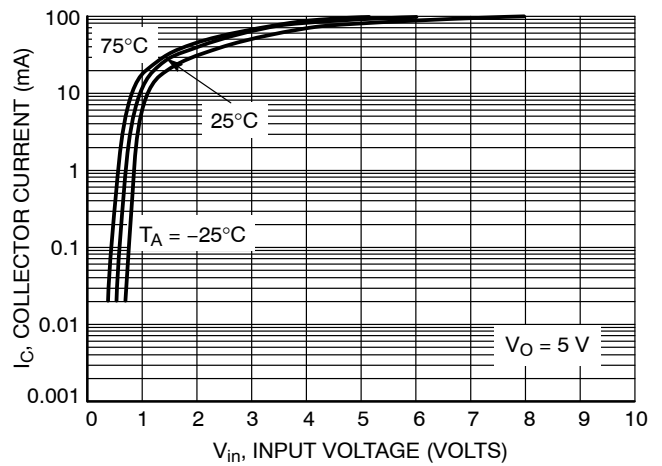

Figure 45. Output Current versus Input Voltage

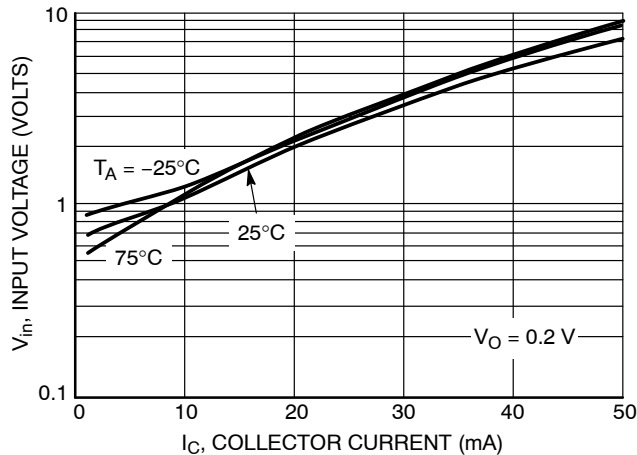

Figure 46. Input Voltage versus Output Current

MUN5311DW1T1G, SMUN5311DW1T1G, NSVMUN5311DW1T1G Series

TYPICAL ELECTRICAL CHARACTERISTICS — MUN5315DW1T1G, SMUN5315DW1T1G
PNP TRANSISTOR

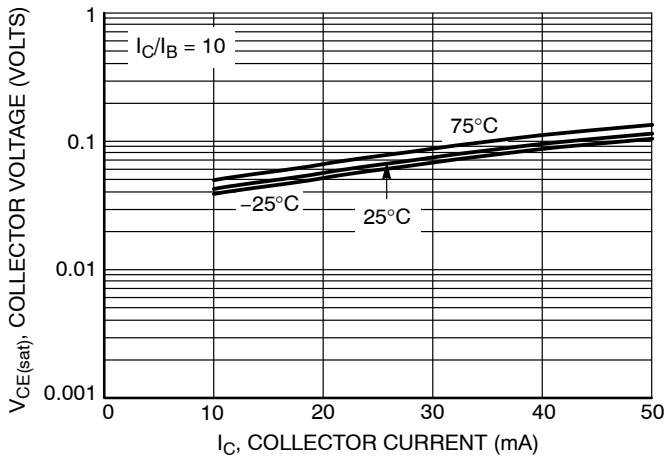

Figure 47. $V_{CE(sat)}$ versus I_C

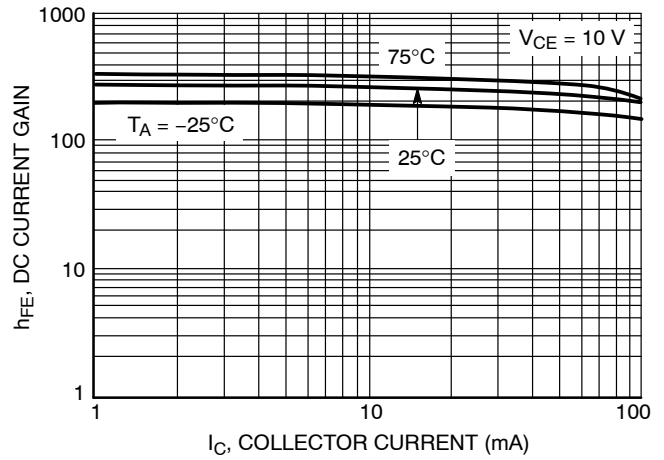

Figure 48. DC Current Gain

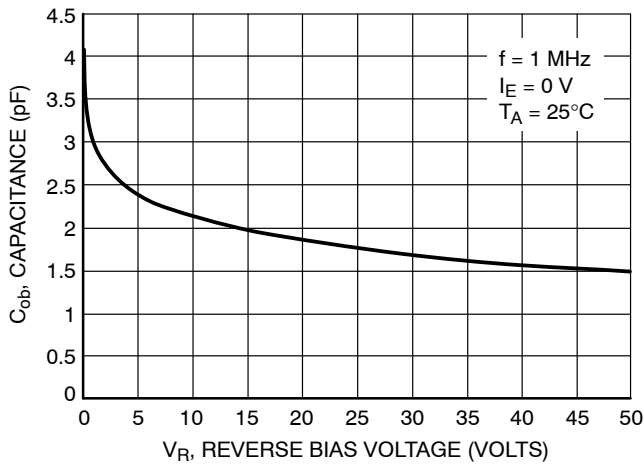

Figure 49. Output Capacitance

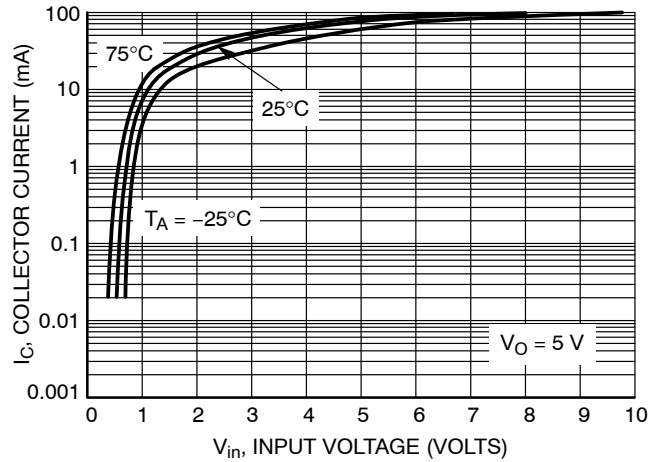

Figure 50. Output Current versus Input Voltage

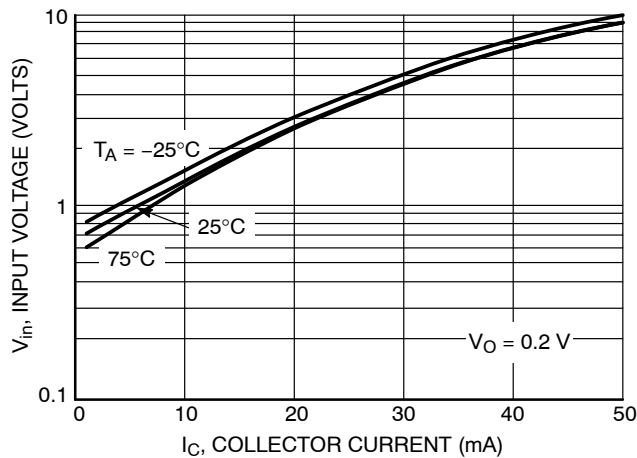

Figure 51. Input Voltage versus Output Current

TYPICAL ELECTRICAL CHARACTERISTICS — MUN5316DW1T1G NPN TRANSISTOR

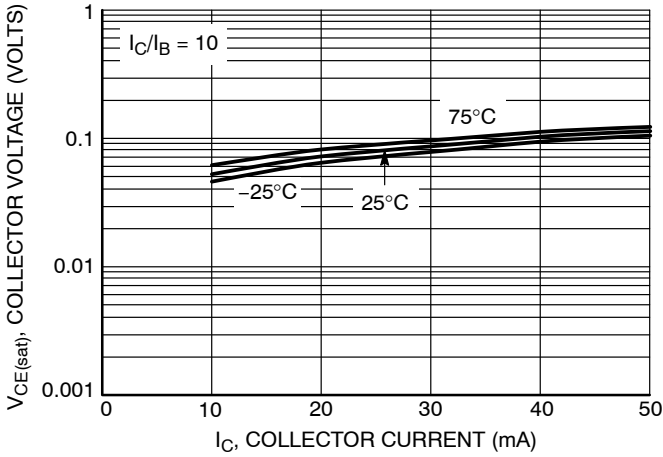

Figure 52. $V_{CE(sat)}$ versus I_C

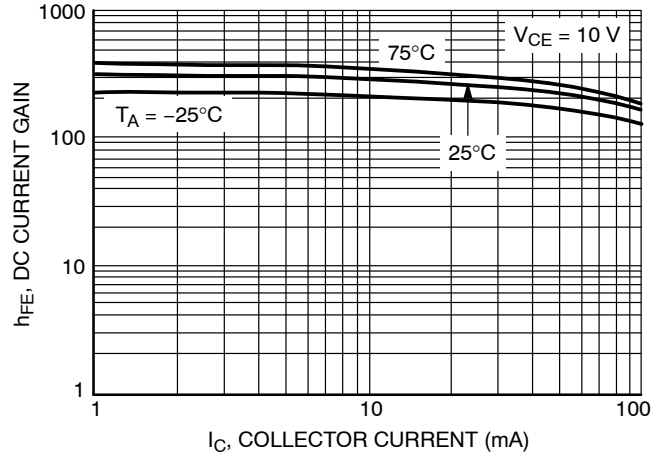

Figure 53. DC Current Gain

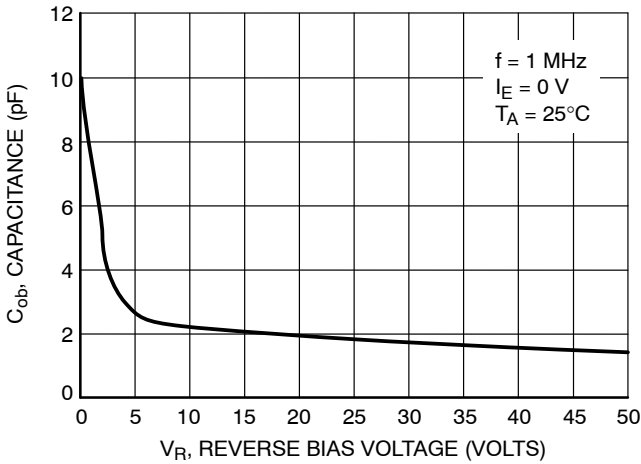

Figure 54. Output Capacitance

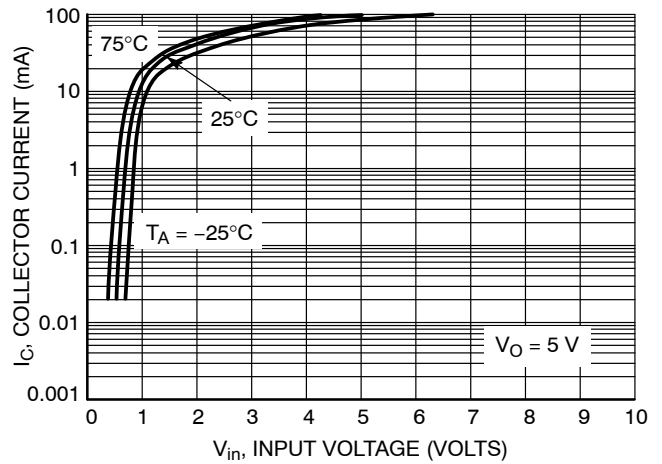

Figure 55. Output Current versus Input Voltage

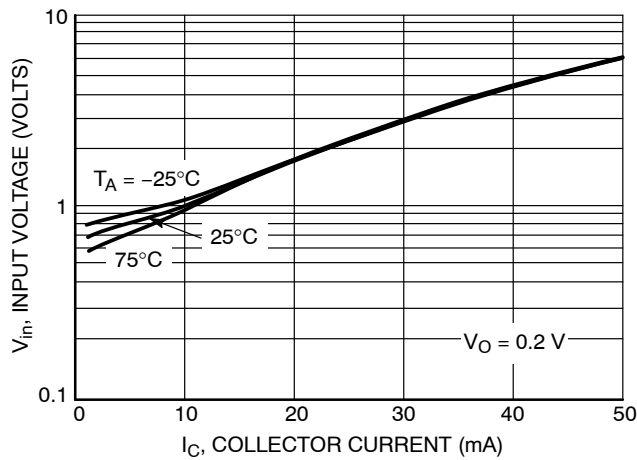

Figure 56. Input Voltage versus Output Current

TYPICAL ELECTRICAL CHARACTERISTICS — MUN5316DW1T1G PNP TRANSISTOR

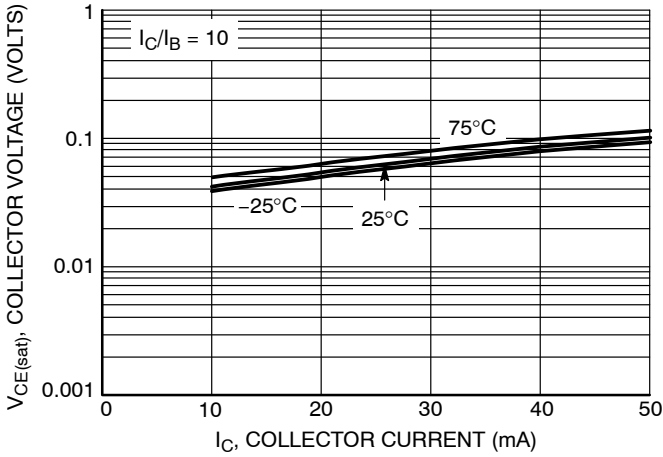

Figure 57. $V_{CE(sat)}$ versus I_C

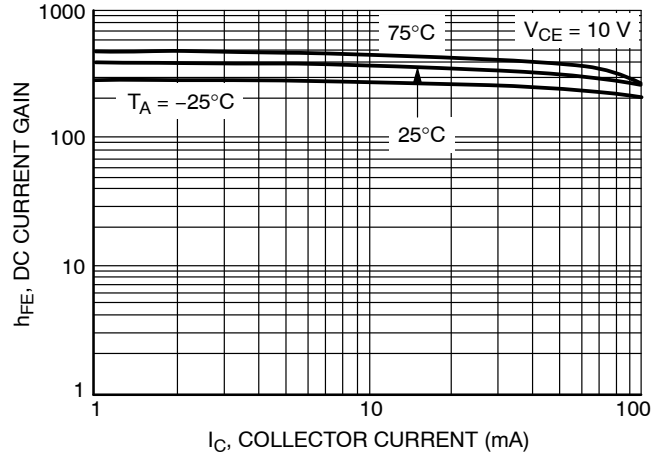

Figure 58. DC Current Gain

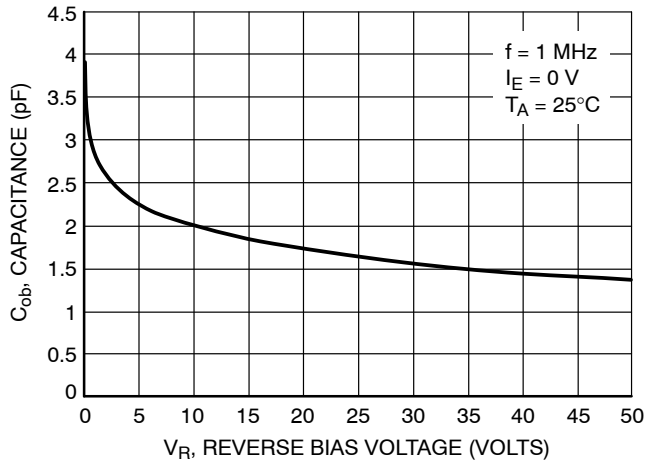

Figure 59. Output Capacitance

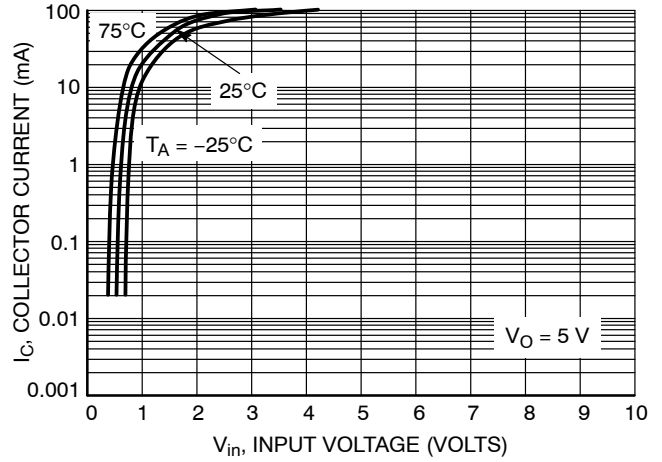

Figure 60. Output Current versus Input Voltage

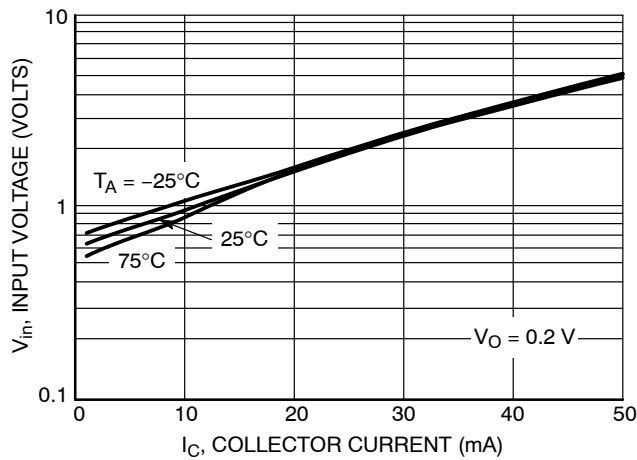

Figure 61. Input Voltage versus Output Current

MUN5311DW1T1G, SMUN5311DW1T1G, NSVMUN5311DW1T1G Series

TYPICAL ELECTRICAL CHARACTERISTICS — MUN5330DW1T1G, SMUN5330DW1T1G
NPN TRANSISTOR

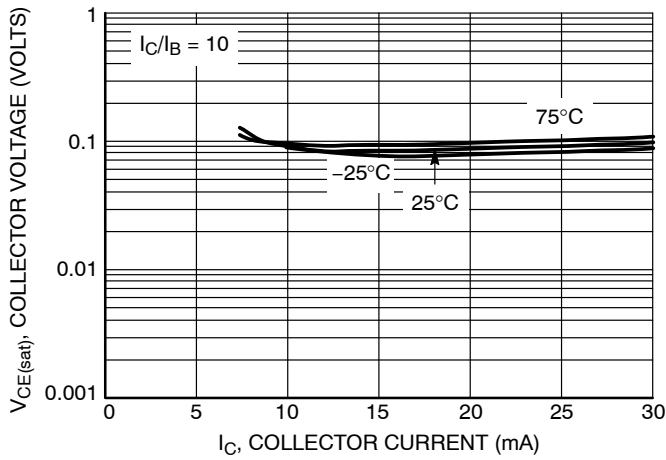

Figure 62. $V_{CE(sat)}$ versus I_C

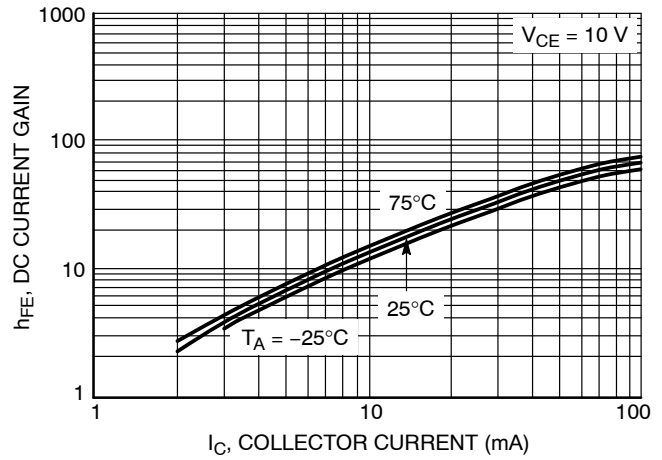

Figure 63. DC Current Gain

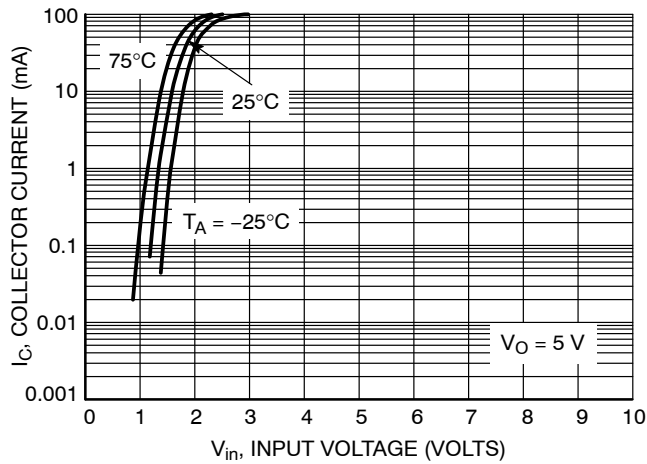

Figure 64. Output Current versus Input Voltage

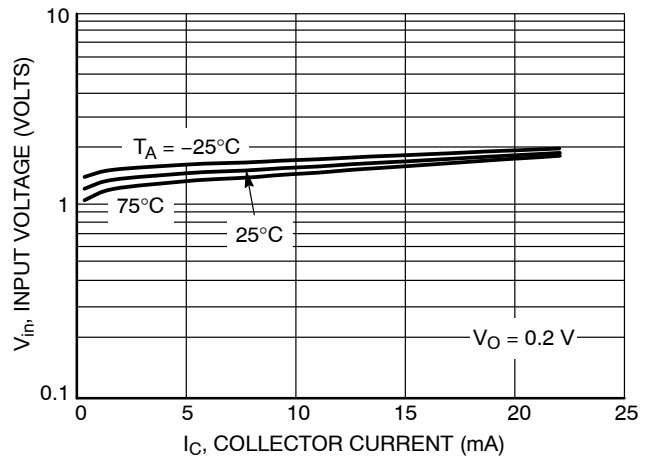

Figure 65. Input Voltage versus Output Current

MUN5311DW1T1G, SMUN5311DW1T1G, NSVMUN5311DW1T1G Series

TYPICAL ELECTRICAL CHARACTERISTICS — MUN5330DW1T1G, SMUN5330DW1T1G
PNP TRANSISTOR

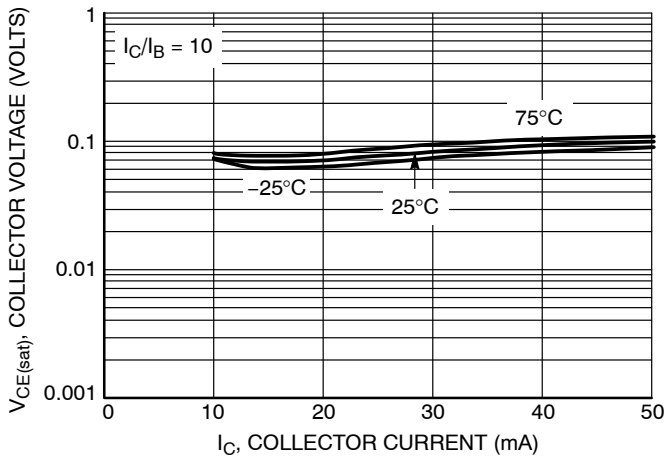

Figure 66. $V_{CE(sat)}$ versus I_C

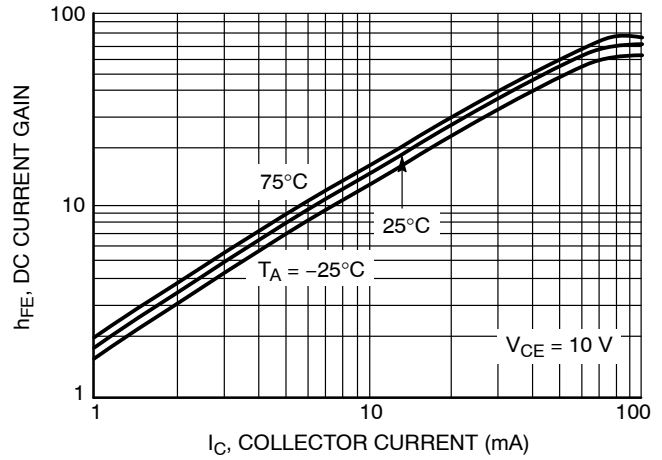

Figure 67. DC Current Gain

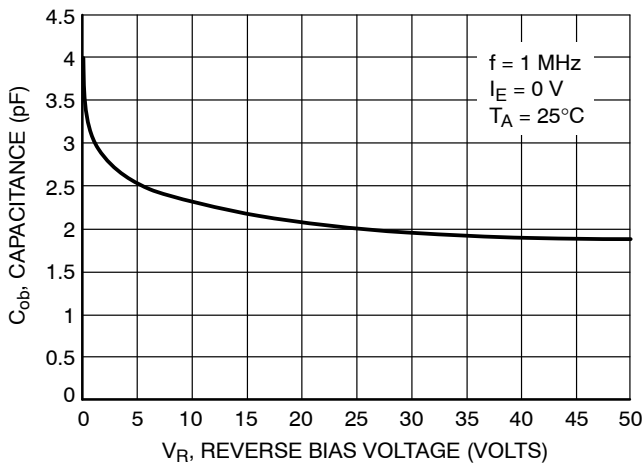

Figure 68. Output Capacitance

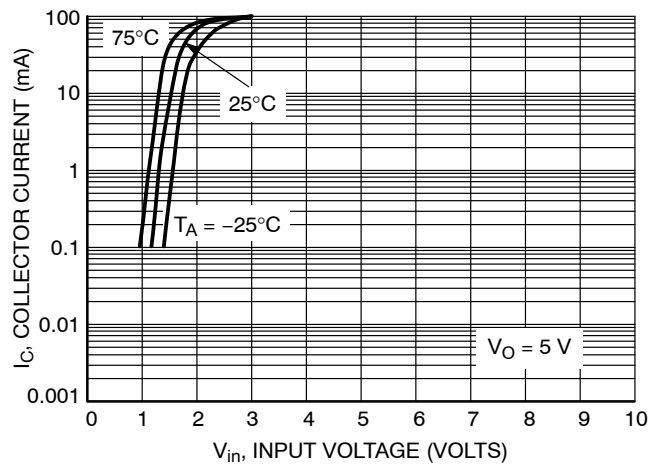

Figure 69. Output Current versus Input Voltage

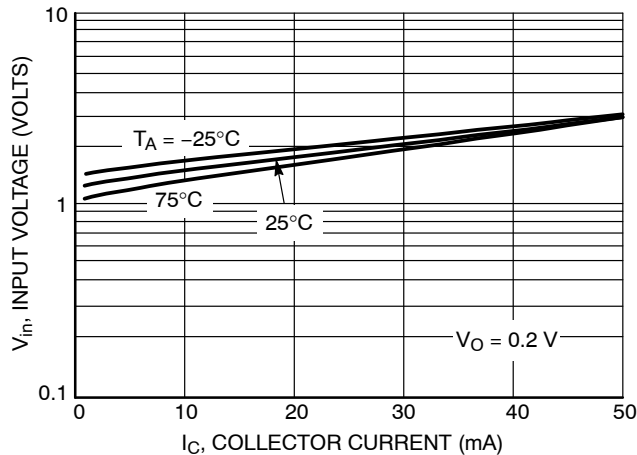

Figure 70. Input Voltage versus Output Current

TYPICAL ELECTRICAL CHARACTERISTICS — MUN5331DW1T1G NPN TRANSISTOR

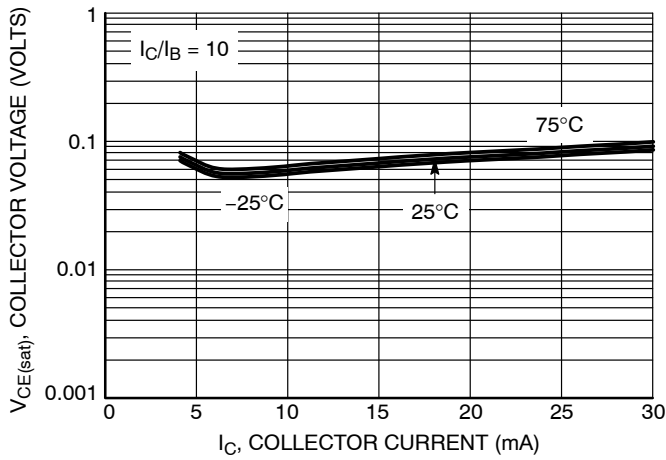

Figure 71. $V_{CE(sat)}$ versus I_C

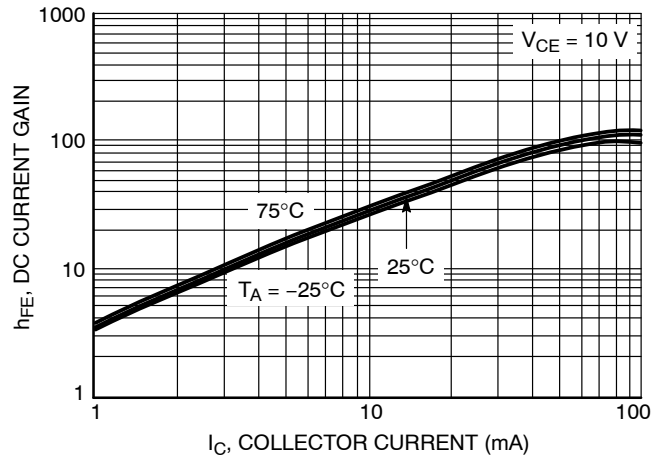

Figure 72. DC Current Gain

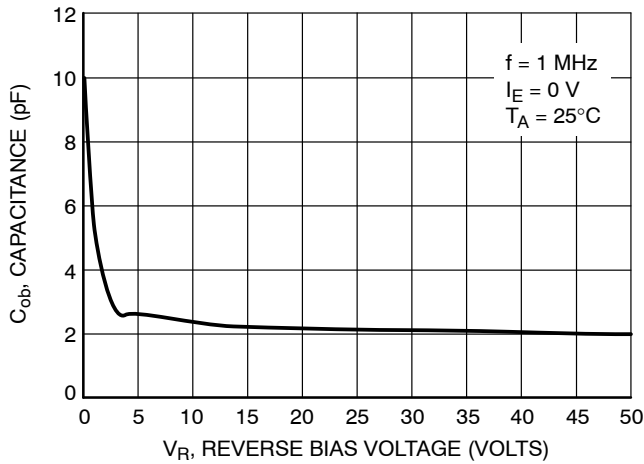

Figure 73. Output Capacitance

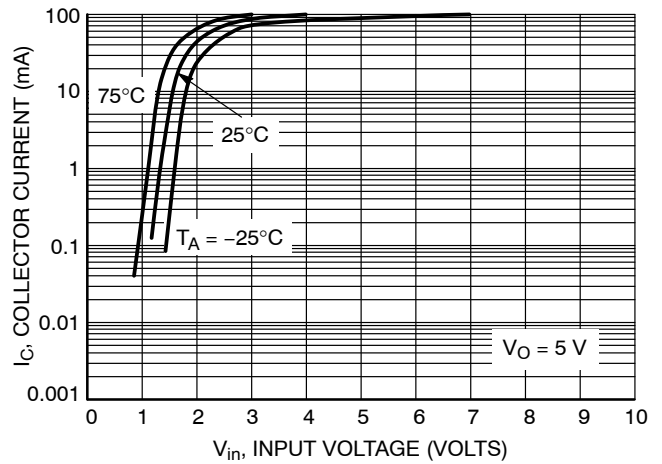

Figure 74. Output Current versus Input Voltage

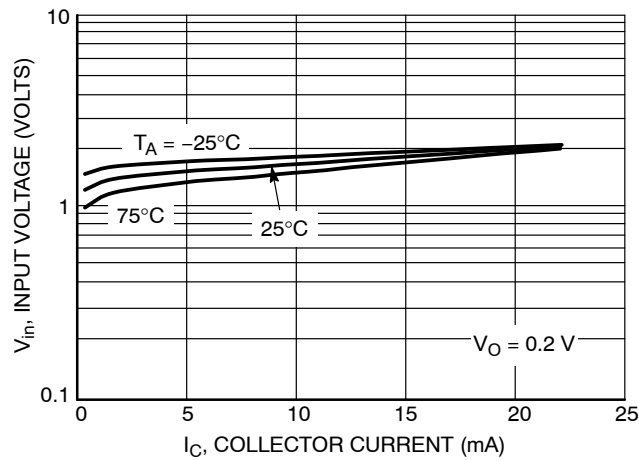

Figure 75. Input Voltage versus Output Current

TYPICAL ELECTRICAL CHARACTERISTICS — MUN5331DW1T1G PNP TRANSISTOR

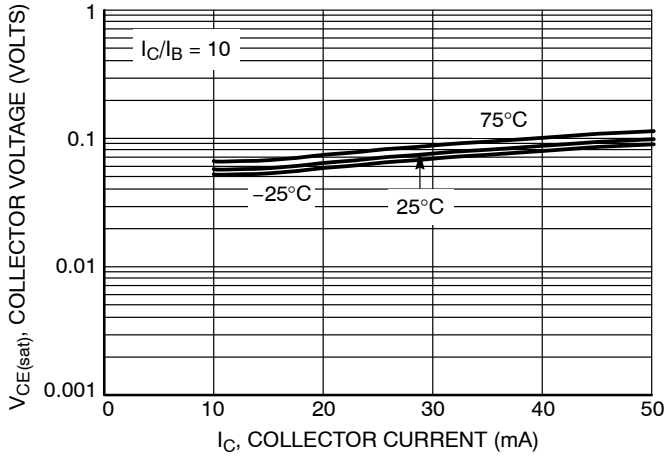

Figure 76. $V_{CE(sat)}$ versus I_C

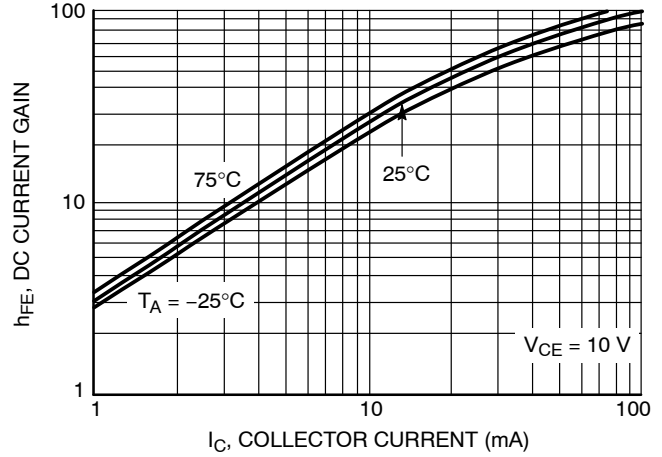

Figure 77. DC Current Gain

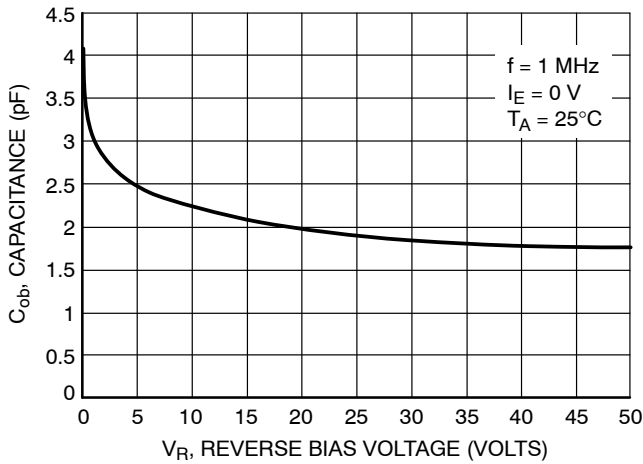

Figure 78. Output Capacitance

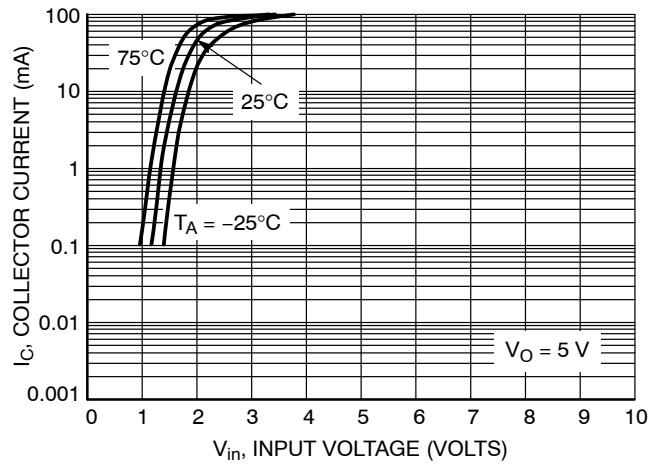

Figure 79. Output Current versus Input Voltage

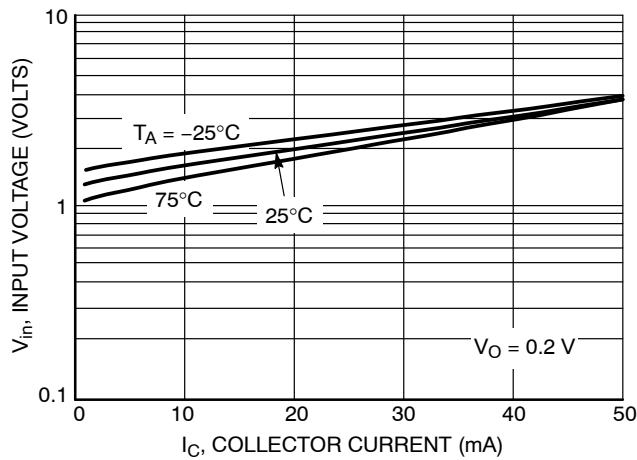

Figure 80. Input Voltage versus Output Current

MUN5311DW1T1G, SMUN5311DW1T1G, NSVMUN5311DW1T1G Series

TYPICAL ELECTRICAL CHARACTERISTICS — MUN5332DW1T1G, NSVMUN5332DW1T1G NPN TRANSISTOR

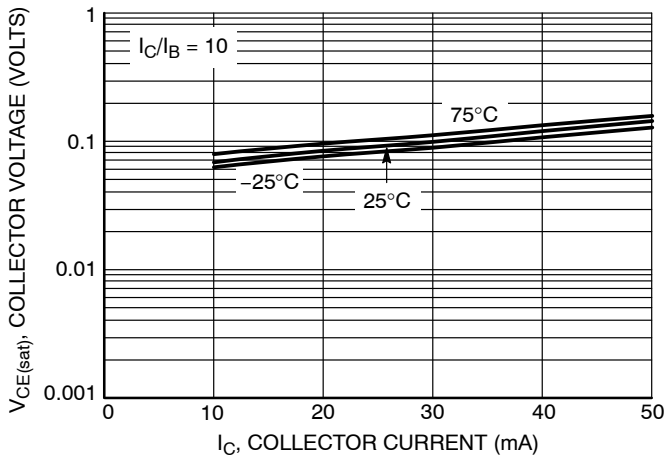

Figure 81. $V_{CE(sat)}$ versus I_C

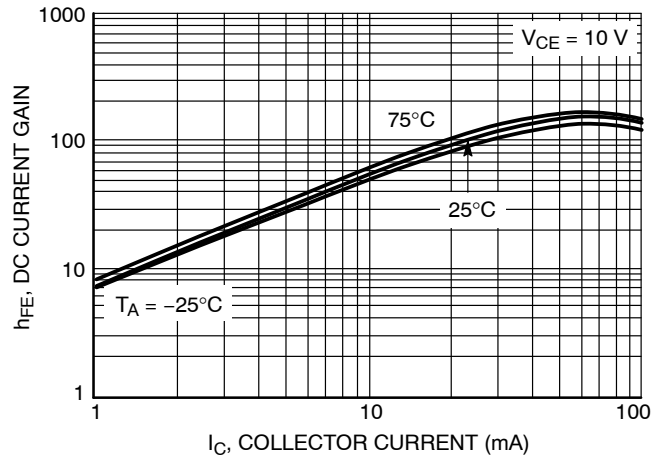

Figure 82. DC Current Gain

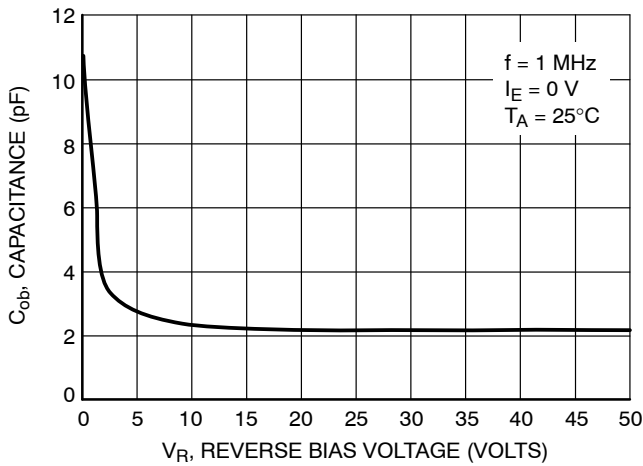

Figure 83. Output Capacitance

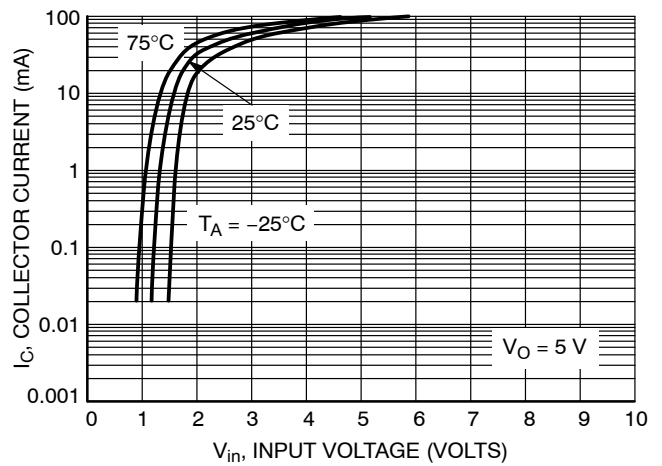

Figure 84. Output Current versus Input Voltage

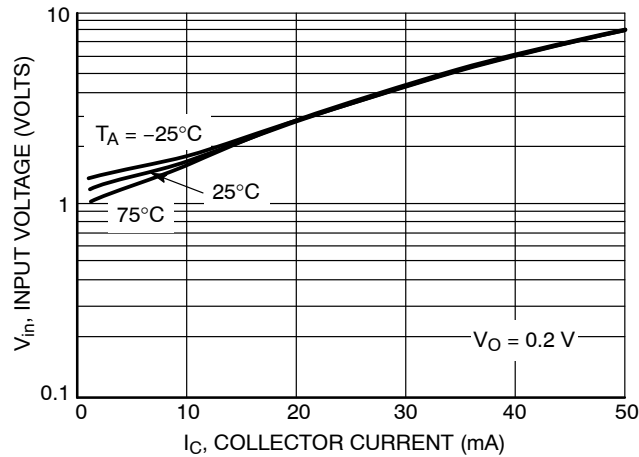

Figure 85. Input Voltage versus Output Current

MUN5311DW1T1G, SMUN5311DW1T1G, NSVMUN5311DW1T1G Series

TYPICAL ELECTRICAL CHARACTERISTICS — MUN5332DW1T1G, NSVMUN5332DW1T1G PNP TRANSISTOR

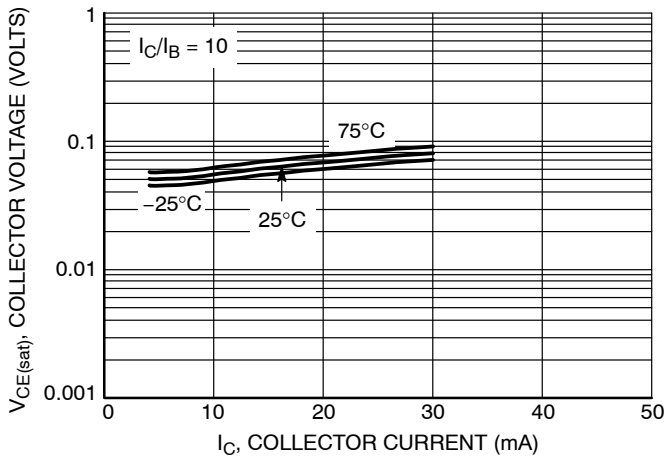

Figure 86. $V_{CE(sat)}$ versus I_C

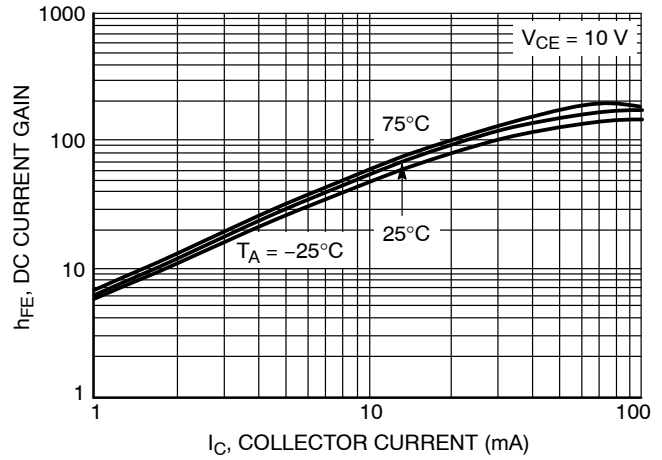

Figure 87. DC Current Gain

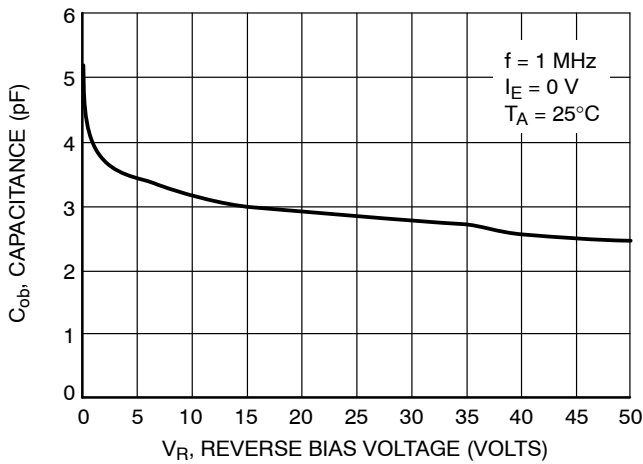

Figure 88. Output Capacitance

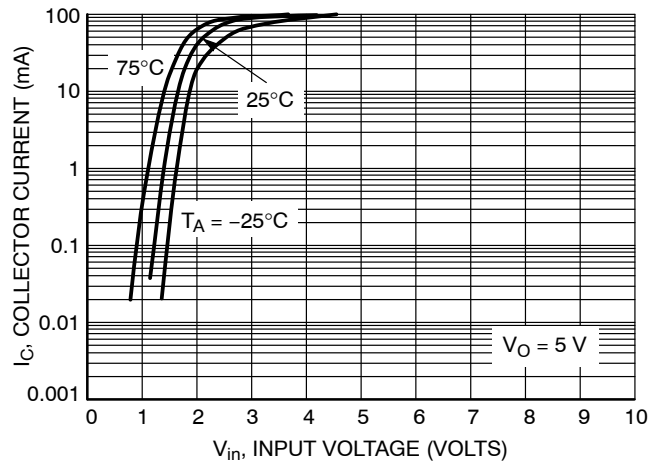

Figure 89. Output Current versus Input Voltage

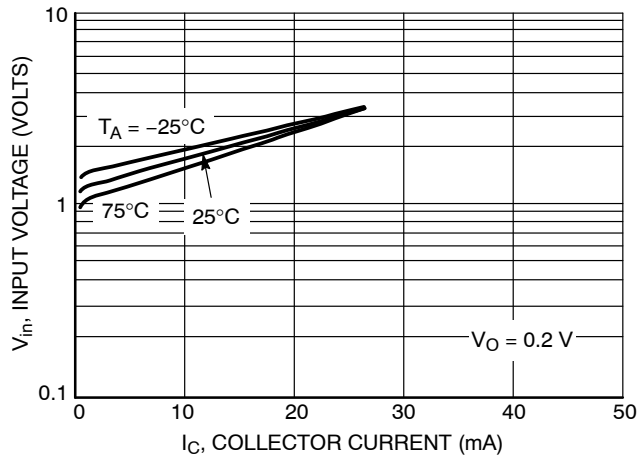

Figure 90. Input Voltage versus Output Current

MUN5311DW1T1G, SMUN5311DW1T1G, NSVMUN5311DW1T1G Series

TYPICAL ELECTRICAL CHARACTERISTICS — MUN5333DW1T1G, NSVMUN5333DW1T1G
NPN TRANSISTOR

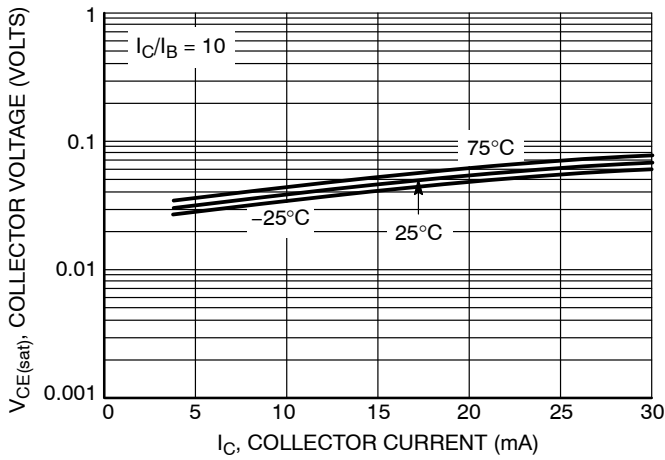

Figure 91. $V_{CE(sat)}$ versus I_C

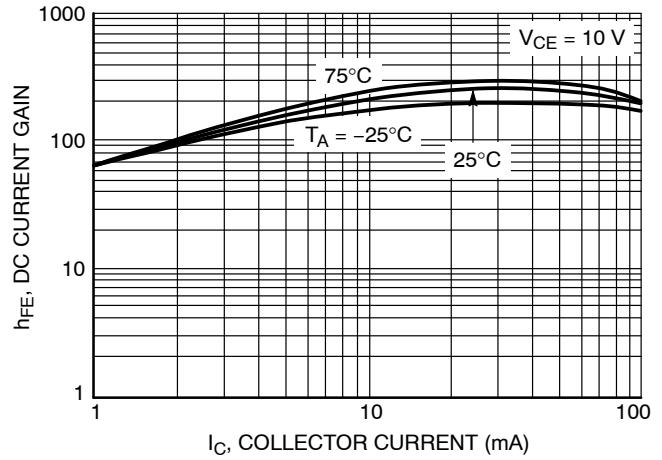

Figure 92. DC Current Gain

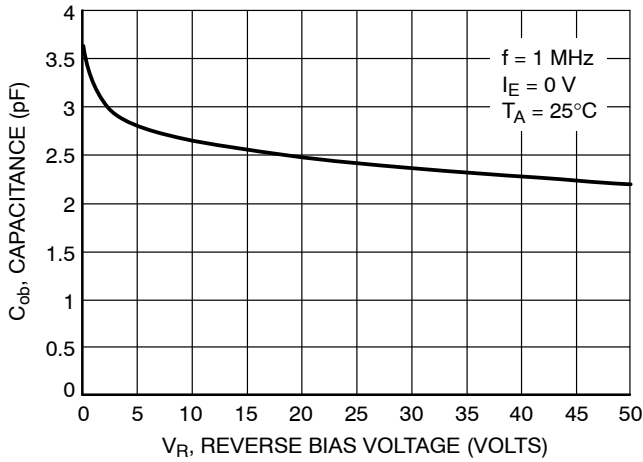

Figure 93. Output Capacitance

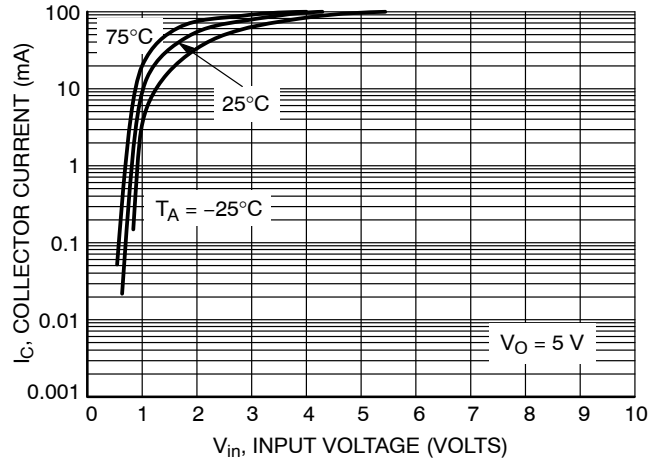

Figure 94. Output Current versus Input Voltage

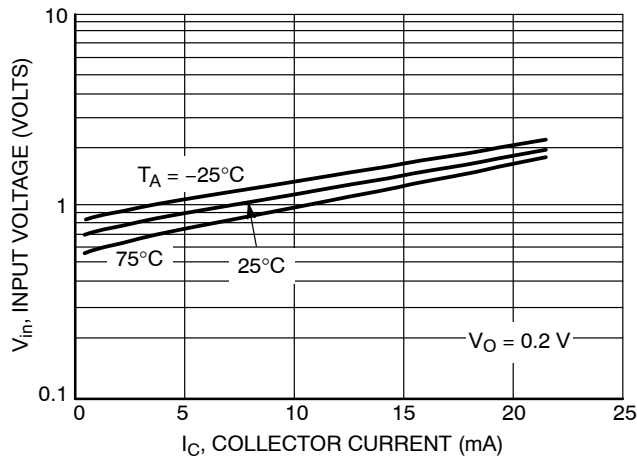

Figure 95. Input Voltage versus Output Current

MUN5311DW1T1G, SMUN5311DW1T1G, NSVMUN5311DW1T1G Series

TYPICAL ELECTRICAL CHARACTERISTICS — MUN5333DW1T1G, NSVMUN5333DW1T1G
PNP TRANSISTOR

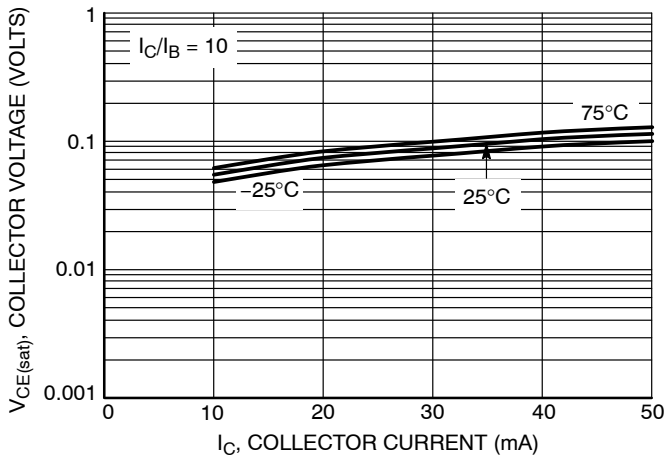

Figure 96. $V_{CE(sat)}$ versus I_C

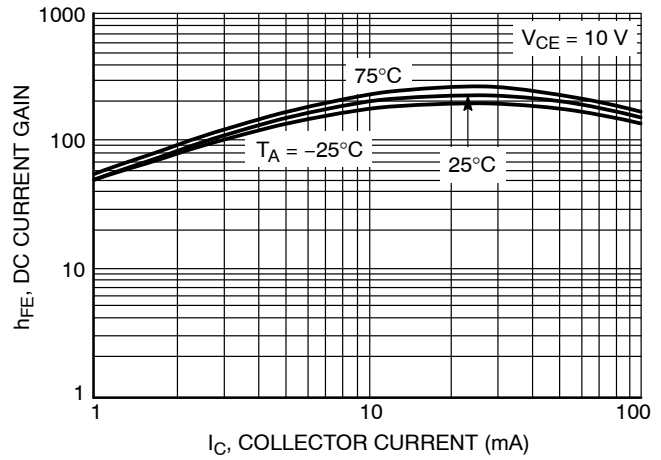

Figure 97. DC Current Gain

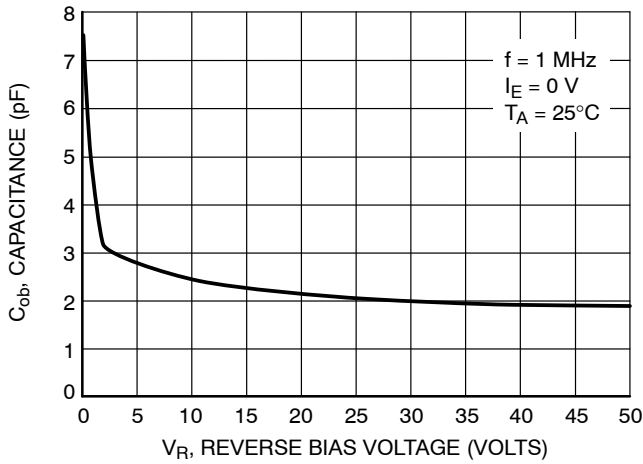

Figure 98. Output Capacitance

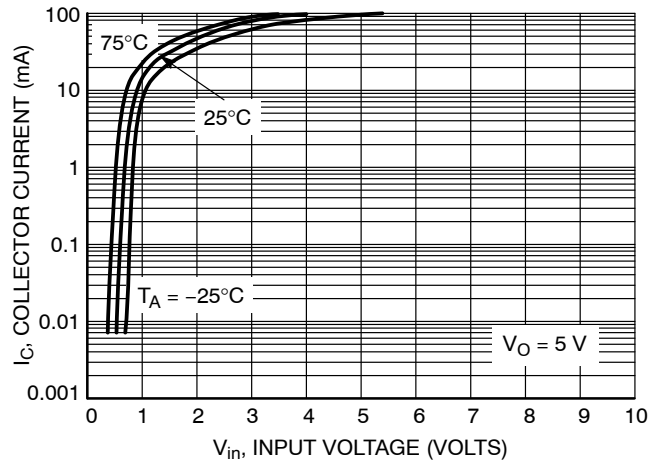

Figure 99. Output Current versus Input Voltage

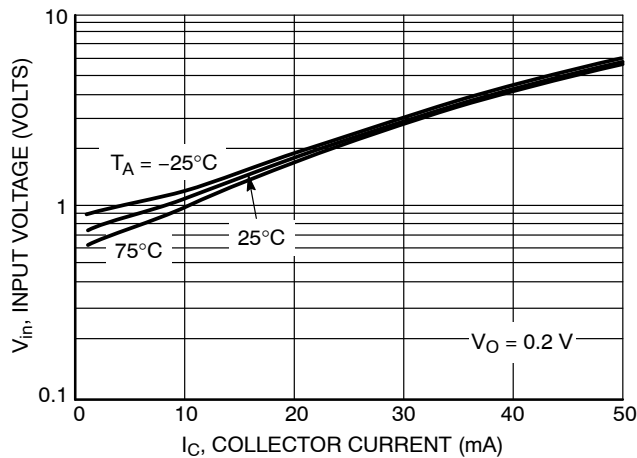

Figure 100. Input Voltage versus Output Current

MUN5311DW1T1G, SMUN5311DW1T1G, NSVMUN5311DW1T1G Series

TYPICAL ELECTRICAL CHARACTERISTICS — MUN5334DW1T1G, NSVMUN5334DW1T1G
NPN TRANSISTOR

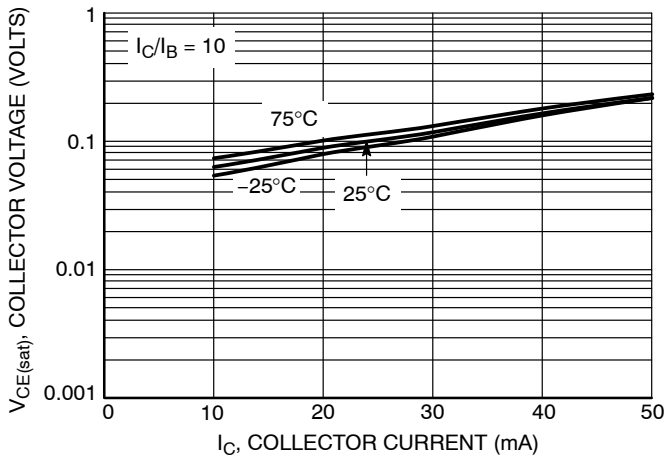

Figure 101. $V_{CE(sat)}$ versus I_C

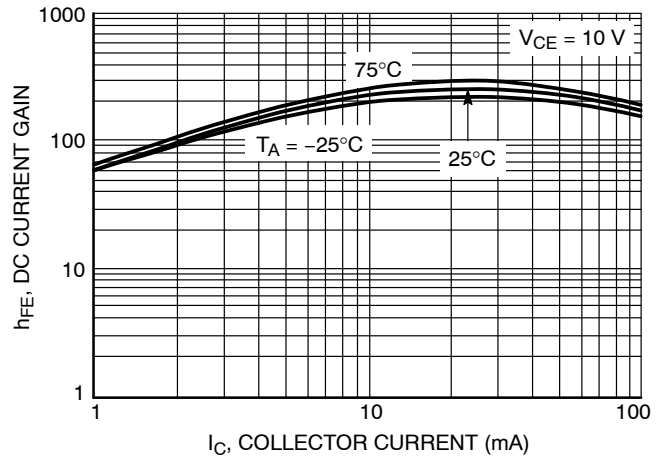

Figure 102. DC Current Gain

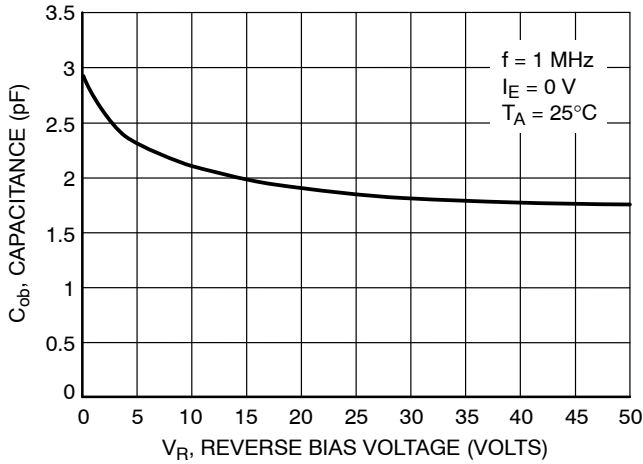

Figure 103. Output Capacitance

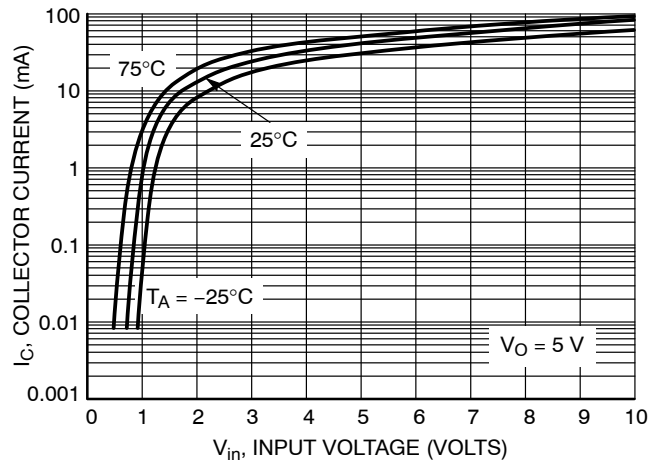

Figure 104. Output Current versus Input Voltage

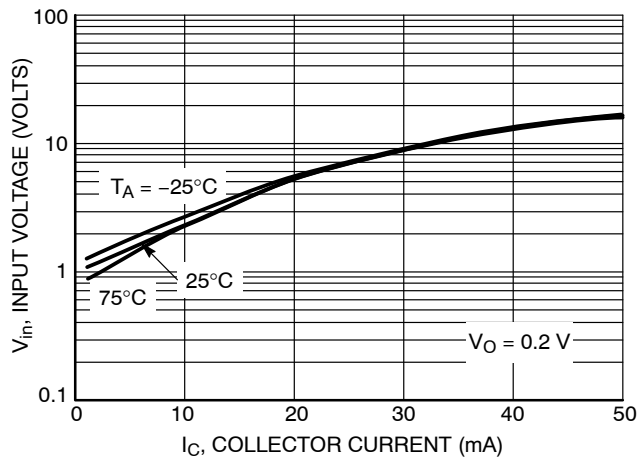

Figure 105. Input Voltage versus Output Current

MUN5311DW1T1G, SMUN5311DW1T1G, NSVMUN5311DW1T1G Series

TYPICAL ELECTRICAL CHARACTERISTICS — MUN5334DW1T1G, NSVMUN5334DW1T1G
PNP TRANSISTOR

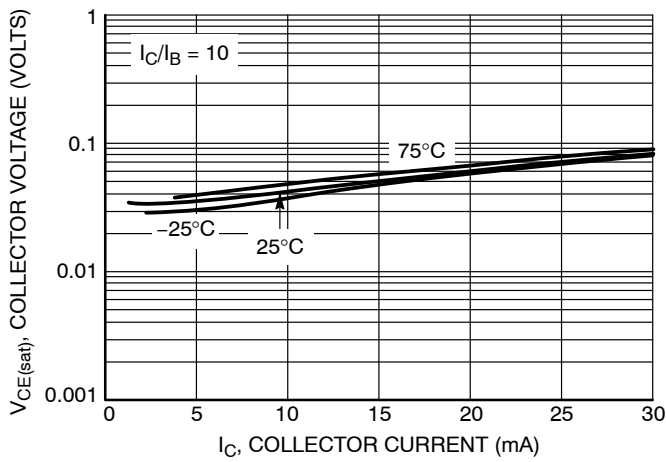

Figure 106. $V_{CE(sat)}$ versus I_C

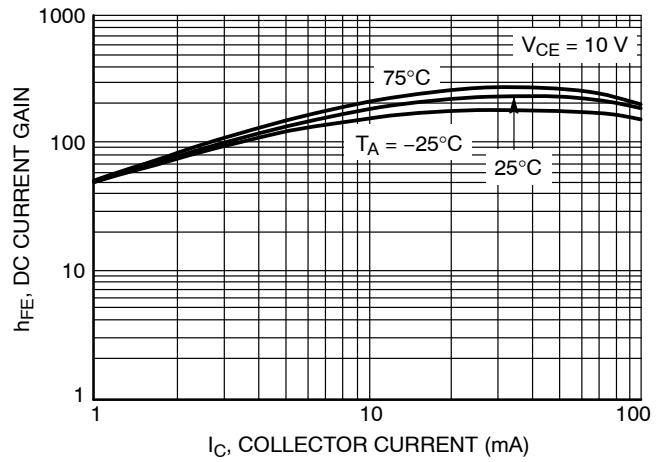

Figure 107. DC Current Gain

MUN5311DW1T1G, SMUN5311DW1T1G, NSVMUN5311DW1T1G Series

TYPICAL ELECTRICAL CHARACTERISTICS — MUN5335DW1T1G, SMUN5335DW1T1G
NPN TRANSISTOR

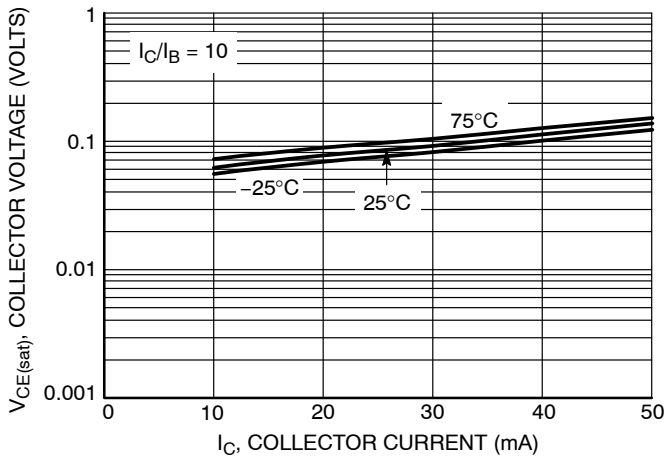

Figure 108. $V_{CE(sat)}$ versus I_C

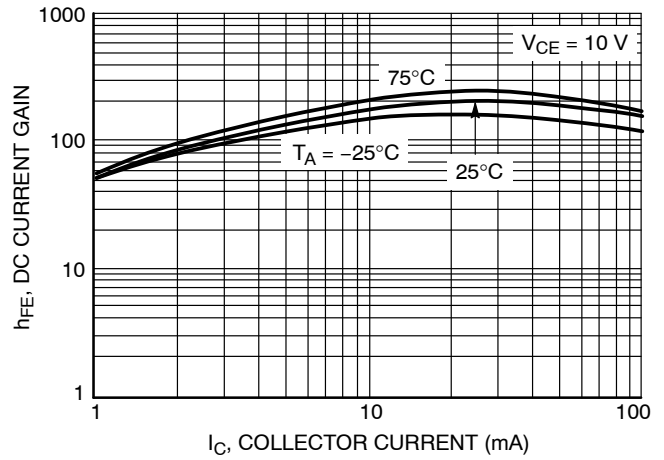

Figure 109. DC Current Gain

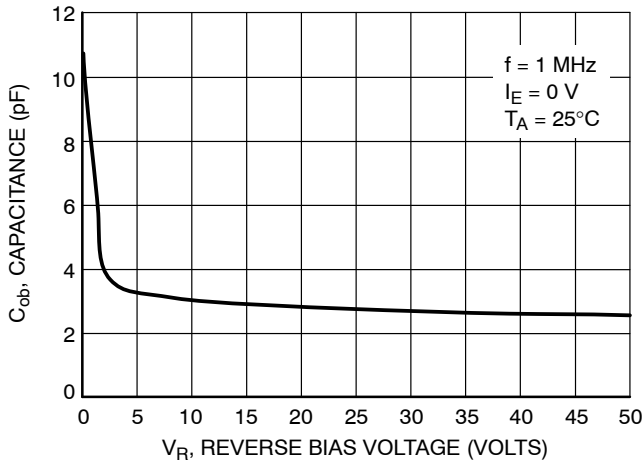

Figure 110. Output Capacitance

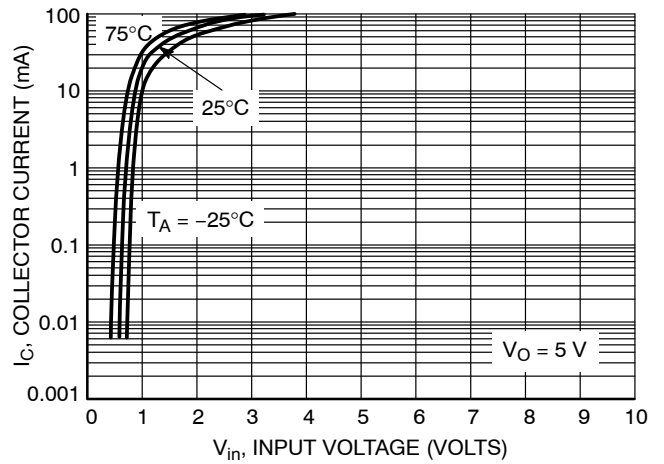

Figure 111. Output Current versus Input Voltage

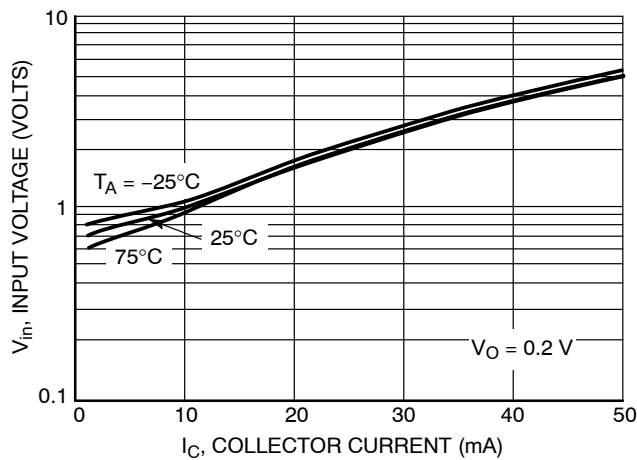

Figure 112. Input Voltage versus Output Current

MUN5311DW1T1G, SMUN5311DW1T1G, NSVMUN5311DW1T1G Series

TYPICAL ELECTRICAL CHARACTERISTICS — MUN5335DW1T1G, SMUN5335DW1T1G
PNP TRANSISTOR

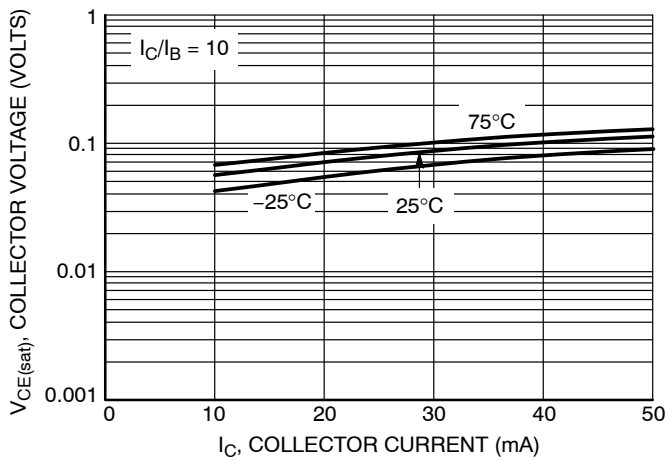

Figure 113. $V_{CE(sat)}$ versus I_C

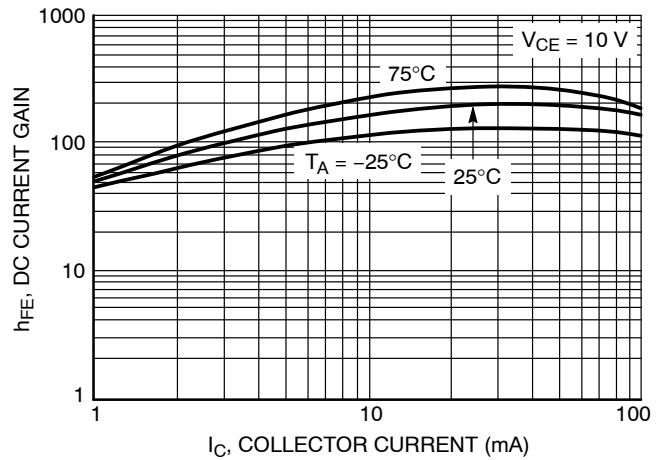

Figure 114. DC Current Gain

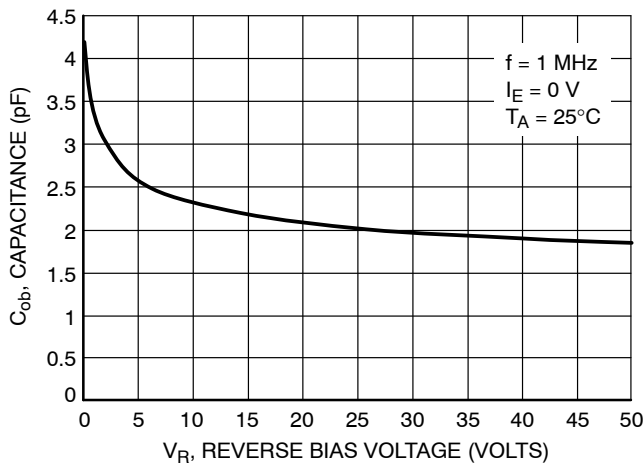

Figure 115. Output Capacitance

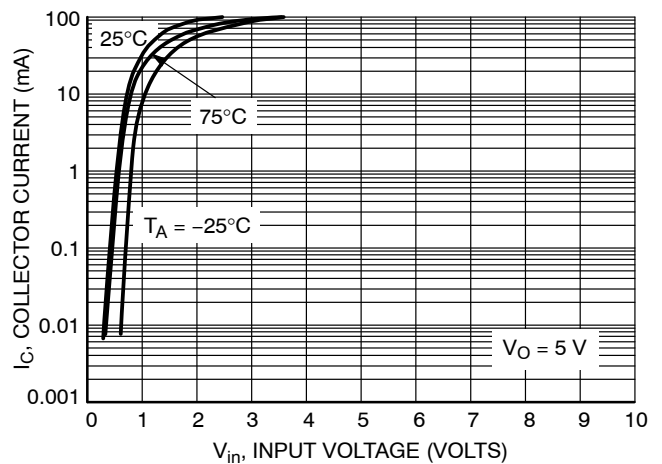

Figure 116. Output Current versus Input Voltage

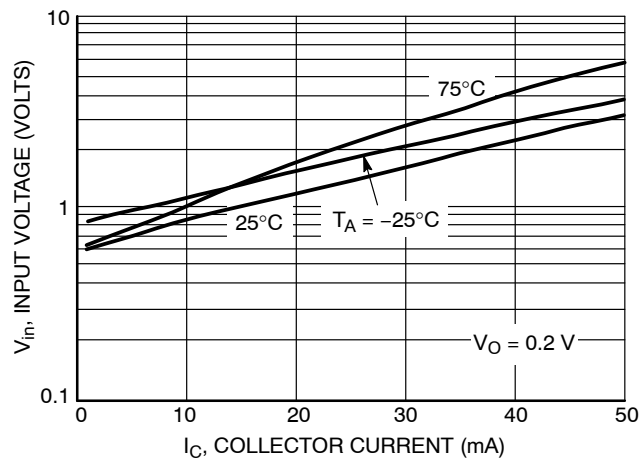

Figure 117. Input Voltage versus Output Current

TYPICAL ELECTRICAL CHARACTERISTICS — MUN5336DW1T1G NPN TRANSISTOR

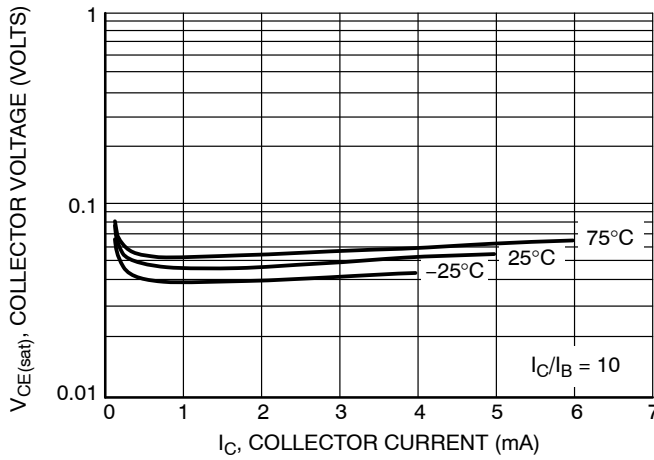

Figure 118. $V_{CE(sat)}$ versus I_C

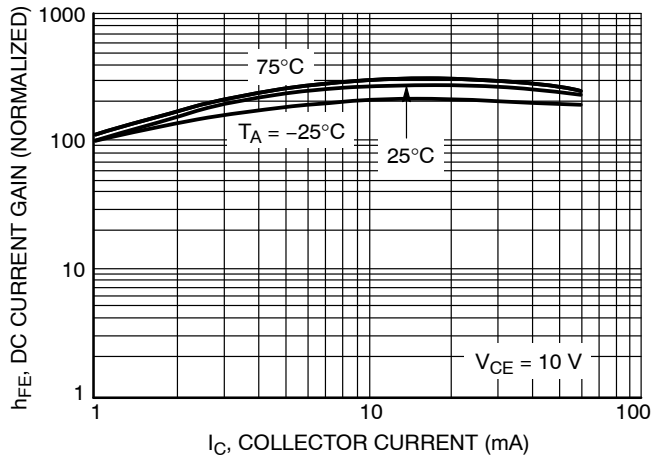

Figure 119. DC Current Gain

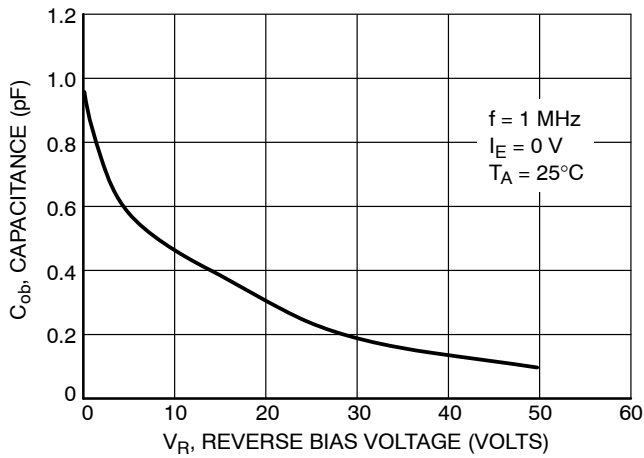

Figure 120. Output Capacitance

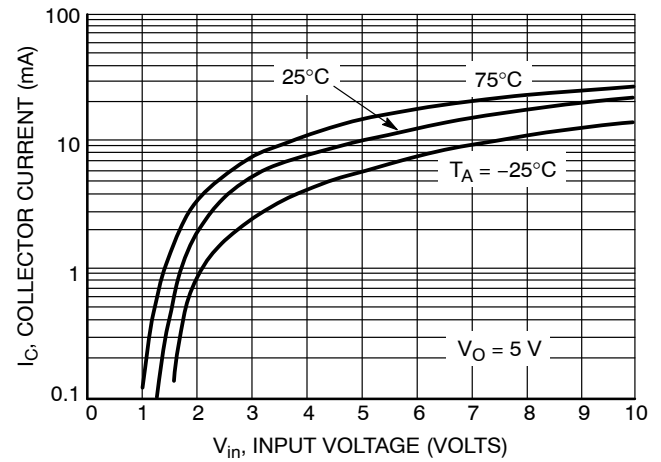

Figure 121. Output Current versus Input Voltage

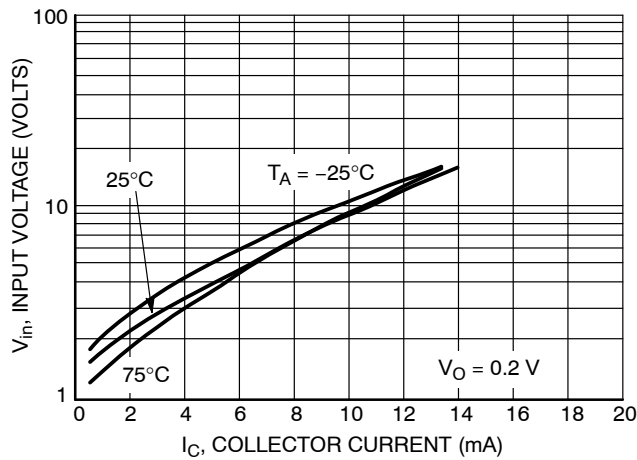

Figure 122. Input Voltage versus Output Current

TYPICAL ELECTRICAL CHARACTERISTICS — MUN5336DW1T1G PNP TRANSISTOR

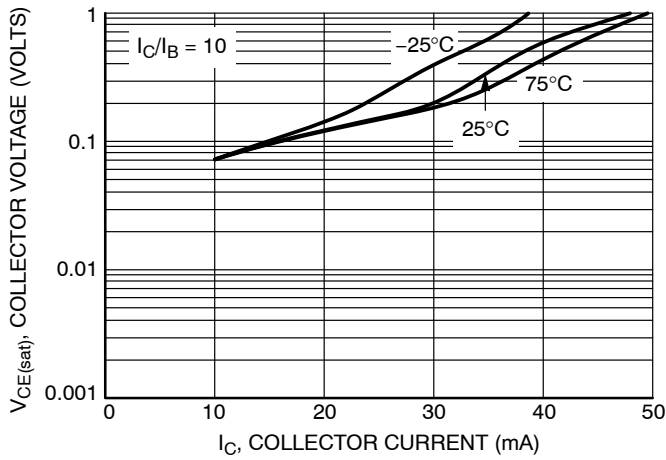

Figure 123. $V_{CE(sat)}$ versus I_C

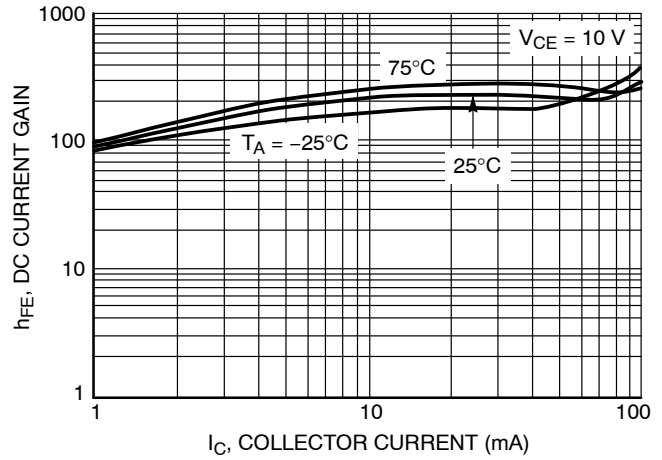

Figure 124. DC Current Gain

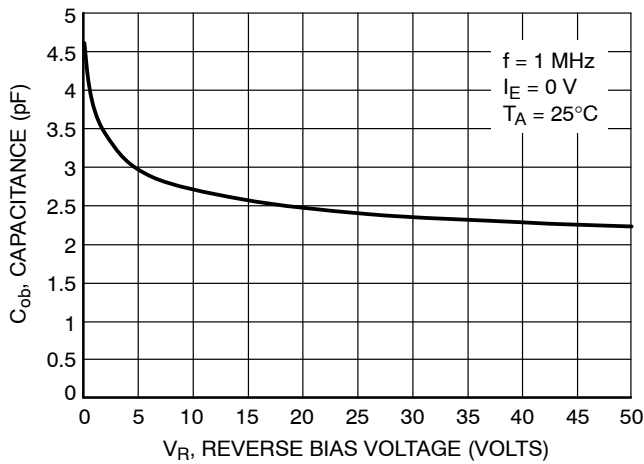

Figure 125. Output Capacitance

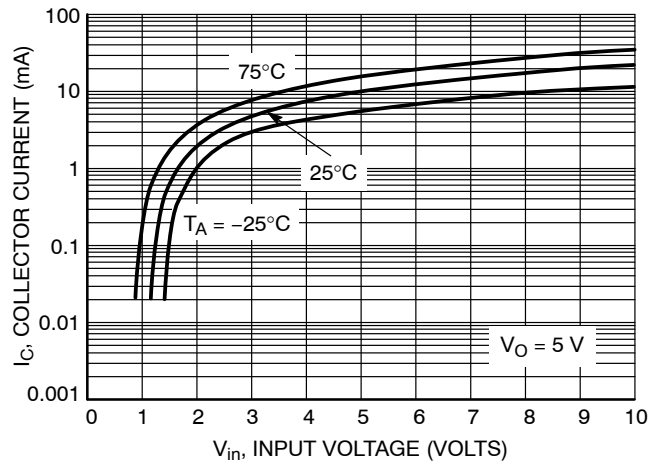

Figure 126. Output Current versus Input Voltage

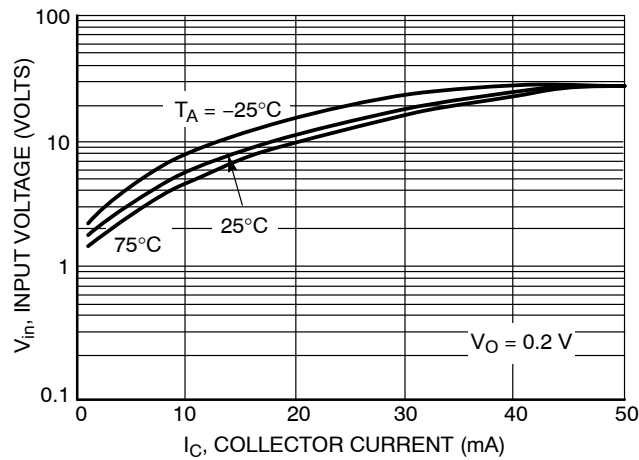

Figure 127. Input Voltage versus Output Current

TYPICAL ELECTRICAL CHARACTERISTICS — MUN5337DW1T1G NPN TRANSISTOR

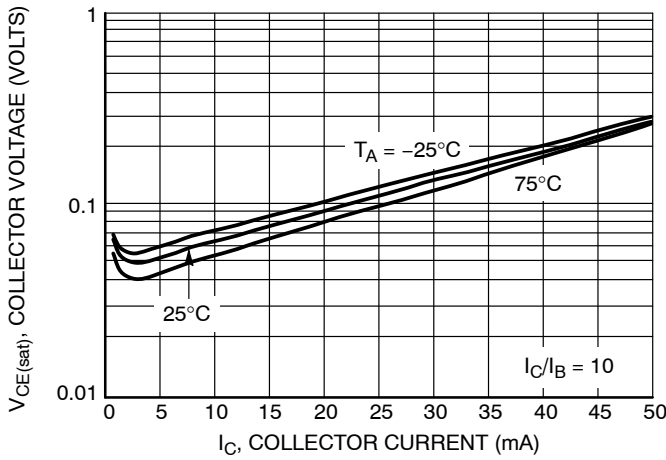

Figure 128. $V_{CE(sat)}$ versus I_C

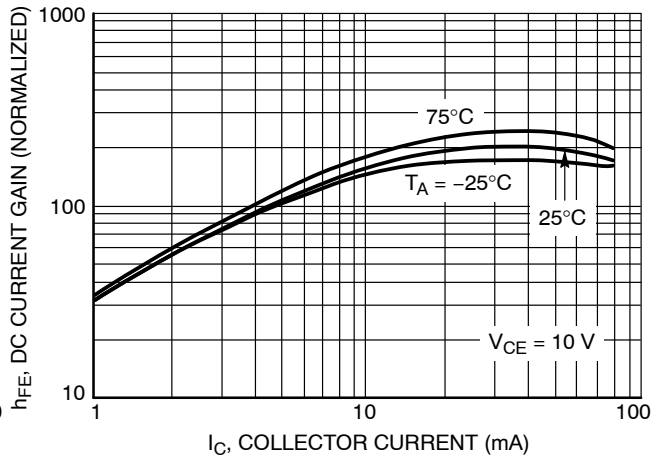

Figure 129. DC Current Gain

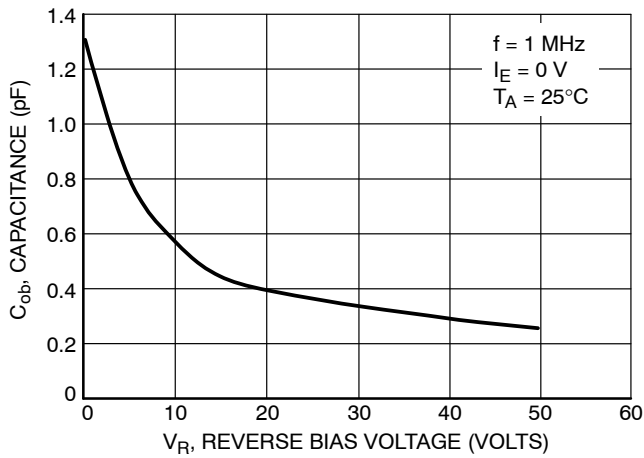

Figure 130. Output Capacitance

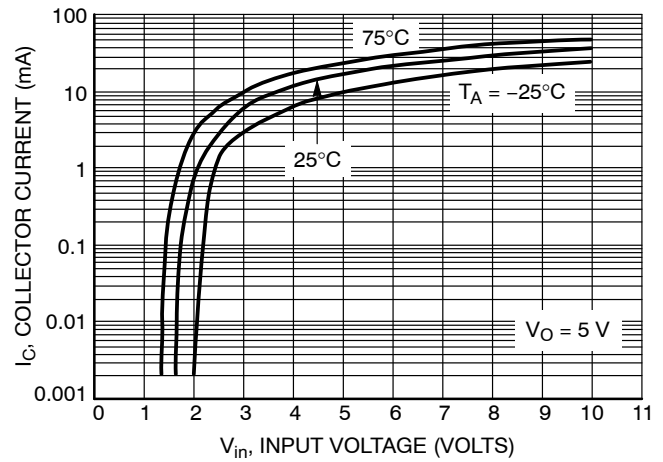

Figure 131. Output Current versus Input Voltage

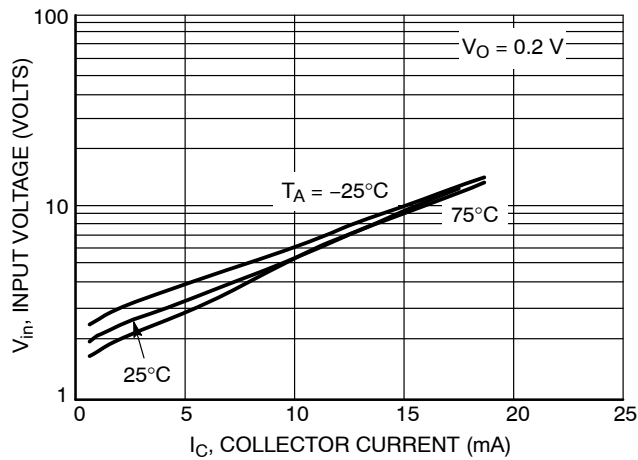

Figure 132. Input Voltage versus Output Current

TYPICAL ELECTRICAL CHARACTERISTICS — MUN5337DW1T1G PNP TRANSISTOR

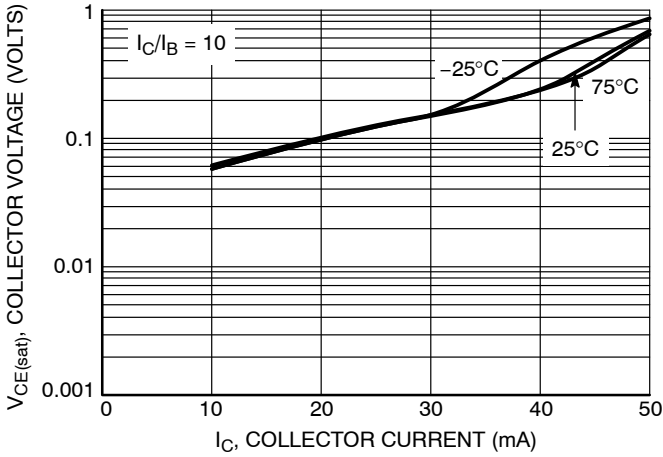

Figure 133. $V_{CE(sat)}$ versus I_C

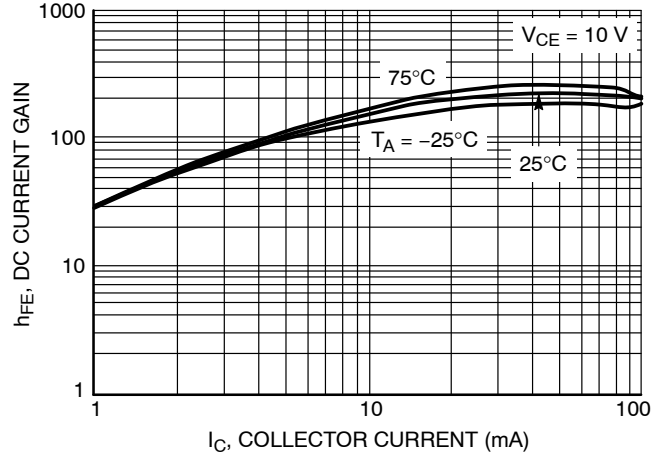

Figure 134. DC Current Gain

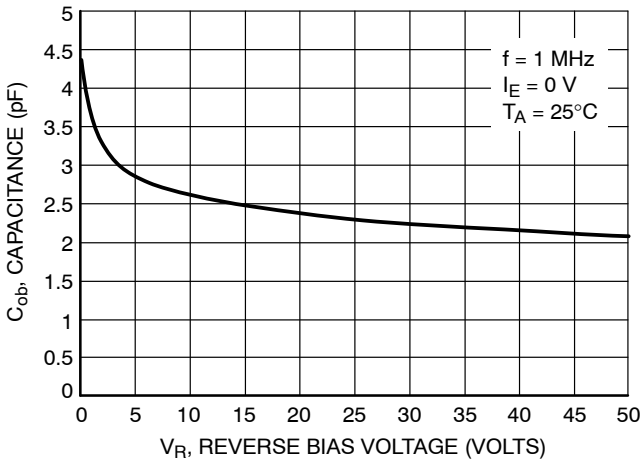

Figure 135. Output Capacitance

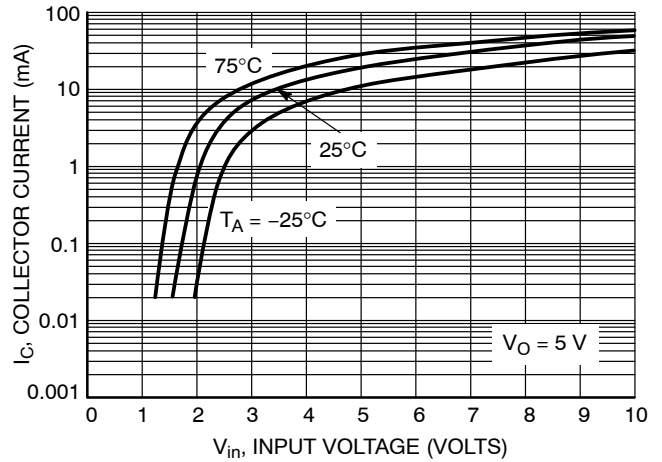

Figure 136. Output Current versus Input Voltage

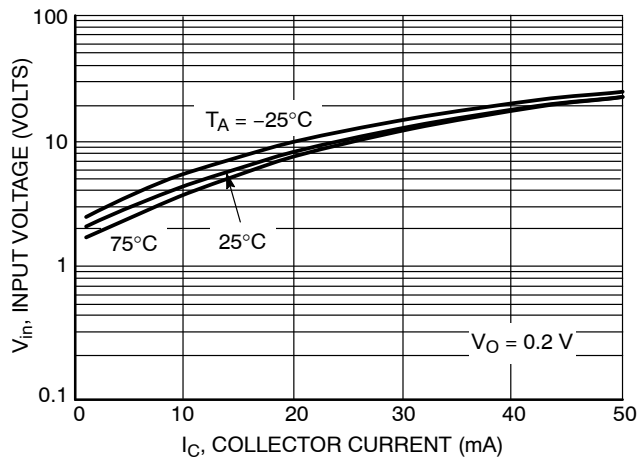
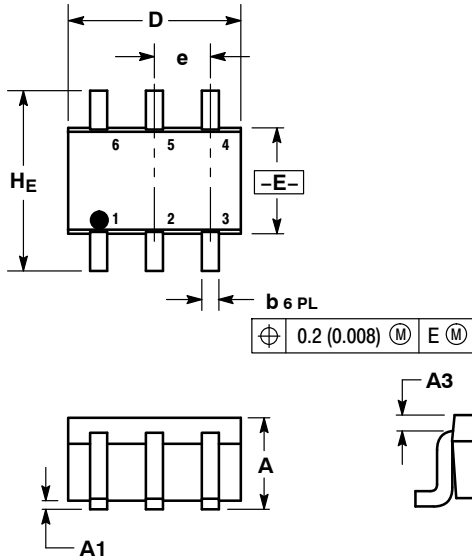

Figure 137. Input Voltage versus Output Current

MUN5311DW1T1G, SMUN5311DW1T1G, NSVMUN5311DW1T1G Series

PACKAGE DIMENSIONS

SC-88/SC70-6/SOT-363
CASE 419B-02
ISSUE W



NOTES:

1. DIMENSIONING AND TOLERANCING PER ANSI Y14.5M, 1982.
2. CONTROLLING DIMENSION: INCH.
3. 419B-01 OBSOLETE, NEW STANDARD 419B-02.

DIM	MILLIMETERS			INCHES		
	MIN	NOM	MAX	MIN	NOM	MAX
A	0.80	0.95	1.10	0.031	0.037	0.043
A1	0.00	0.05	0.10	0.000	0.002	0.004
A3	0.20 REF			0.008 REF		
b	0.10	0.21	0.30	0.004	0.008	0.012
C	0.10	0.14	0.25	0.004	0.005	0.010
D	1.80	2.00	2.20	0.070	0.078	0.086
E	1.15	1.25	1.35	0.045	0.049	0.053
e	0.65 BSC			0.026 BSC		
L	0.10	0.20	0.30	0.004	0.008	0.012
HE	2.00	2.10	2.20	0.078	0.082	0.086

STYLE 1:

- PIN 1: EMITTER 2
- BASE 2
- COLLECTOR 1
- EMITTER 1
- BASE 1
- COLLECTOR 2

SOLDERING FOOTPRINT*

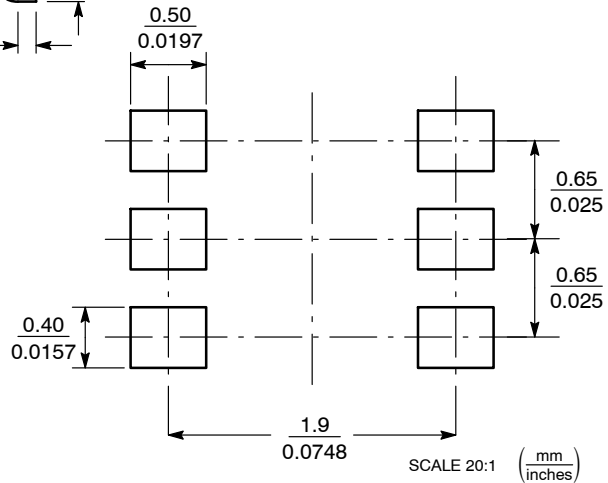

SC-88/SC70-6/SOT-363

*For additional information on our Pb-Free strategy and soldering details, please download the ON Semiconductor Soldering and Mounting Techniques Reference Manual, SOLDERRM/D.

ON Semiconductor and are registered trademarks of Semiconductor Components Industries, LLC (SCILLC). SCILLC reserves the right to make changes without further notice to any products herein. SCILLC makes no warranty, representation or guarantee regarding the suitability of its products for any particular purpose, nor does SCILLC assume any liability arising out of the application or use of any product or circuit, and specifically disclaims any and all liability, including without limitation special, consequential or incidental damages. "Typical" parameters which may be provided in SCILLC data sheets and/or specifications can and do vary in different applications and actual performance may vary over time. All operating parameters, including "Typicals" must be validated for each customer application by customer's technical experts. SCILLC does not convey any license under its patent rights nor the rights of others. SCILLC products are not designed, intended, or authorized for use as components in systems intended for surgical implant into the body, or other applications intended to support or sustain life, or for any other application in which the failure of the SCILLC product could create a situation where personal injury or death may occur. Should Buyer purchase or use SCILLC products for any such unintended or unauthorized application, Buyer shall indemnify and hold SCILLC and its officers, employees, subsidiaries, affiliates, and distributors harmless against all claims, costs, damages, and expenses, and reasonable attorney fees arising out of, directly or indirectly, any claim of personal injury or death associated with such unintended or unauthorized use, even if such claim alleges that SCILLC was negligent regarding the design or manufacture of the part. SCILLC is an Equal Opportunity/Affirmative Action Employer. This literature is subject to all applicable copyright laws and is not for resale in any manner.

PUBLICATION ORDERING INFORMATION

LITERATURE FULFILLMENT:
Literature Distribution Center for ON Semiconductor
P.O. Box 5163, Denver, Colorado 80217 USA
Phone: 303-675-2175 or 800-344-3860 Toll Free USA/Canada
Fax: 303-675-2176 or 800-344-3867 Toll Free USA/Canada
Email: orderlit@onsemi.com

N. American Technical Support: 800-282-9855 Toll Free
USA/Canada
Europe, Middle East and Africa Technical Support:
Phone: 421 33 790 2910
Japan Customer Focus Center
Phone: 81-3-5817-1050

ON Semiconductor Website: www.onsemi.com
Order Literature: <http://www.onsemi.com/orderlit>
For additional information, please contact your local Sales Representative