

## Features

- Ultra Low Leakage Current
- Excellent High Temperature Stability
- Patented Super Barrier Rectifier Technology
- Soft, Fast Switching Capability
- 150°C Operating Junction Temperature
- **Lead Free Finish, RoHS Compliant (Note 1)**
- **“Green” Device (Note 4)**

## Mechanical Data

- Case: DFN3030-4
- Case Material: Molded Plastic “Green” Molding Compound, UL Flammability Classification Rating 94V-0
- Moisture Sensitivity: Level 1 per J-STD-020
- Terminals: Finish – NiPdAu Over Copper Lead Frame, Solderable per MIL-STD-202, Method 208 **(e3)**
- Polarity: See Diagram
- Marking Information: See Page 3
- Ordering Information: See Page 3
- Weight: 0.02 grams (approximate)

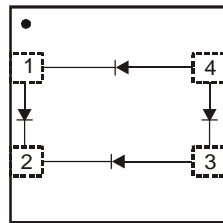

Top View  
Device Schematic

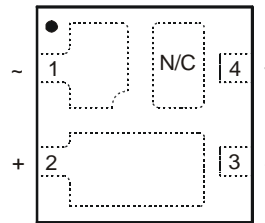

Top View  
Pin Configuration

## Maximum Ratings @T<sub>A</sub> = 25°C unless otherwise specified

Single phase, half wave, 60Hz, resistive or inductive load.  
For capacitance load, derate current by 20%.

Characteristic	Symbol	Value	Unit
Peak Repetitive Reverse Voltage	V <sub>RRM</sub>	100	V
Working Peak Reverse Voltage	V <sub>RWM</sub>		
DC Blocking Voltage	V <sub>RM</sub>		
RMS Reverse Voltage	V <sub>R(RMS)</sub>	70	V
Average Rectified Output Current	I <sub>O</sub>	500	mA
Non-Repetitive Peak Forward Surge Current 8.3ms Single Half Sine-Wave Superimposed on Rated Load (Per Diode)	I <sub>FSM</sub>	8	A

## Thermal Characteristics

Characteristic	Symbol	Typ	Max	Unit
Power Dissipation (Note 2)	P <sub>D</sub>	-	0.56	W
Thermal Resistance Junction to Ambient Air (Note 2)	R <sub>θJA</sub>	-	222	°C/W
Thermal Resistance Junction to Ambient Air (Note 3)	R <sub>θJA</sub>	-	149	°C/W
Operating and Storage Temperature Range	T <sub>J</sub> , T <sub>STG</sub>	-55 to +150		°C

## Electrical Characteristics @T<sub>A</sub> = 25°C unless otherwise specified

Characteristic	Symbol	Min	Typ	Max	Unit	Test Condition
Reverse Breakdown Voltage (Note 4)	V <sub>(BR)R</sub>	100	-	-	V	I <sub>R</sub> = 250 μA
Forward Voltage (Per Diode)	V <sub>F</sub>	-	0.54 0.67 0.56	0.60 0.73 0.63	V	I <sub>F</sub> = 0.25A, T <sub>J</sub> = 25°C I <sub>F</sub> = 0.5A, T <sub>J</sub> = 25°C I <sub>F</sub> = 0.5A, T <sub>J</sub> = 125°C
Reverse Current (Note 4) (Per Diode)	I <sub>R</sub>	-	0.3 32	25 250	μA	V <sub>R</sub> = 100V, T <sub>J</sub> = 25°C V <sub>R</sub> = 100V, T <sub>J</sub> = 125°C

- Notes:
1. EU Directive 2002/95/EC (RoHS). All applicable RoHS exemptions applied, see EU Directive 2002/95/EC Annex Notes.
  2. FR-4 PCB, 2 oz. Copper, minimum recommended pad layout per <http://www.diodes.com/datasheets/ap02001.pdf>.
  3. Polyimide PCB, 2 oz. copper; minimum recommended pad layout per <http://www.diodes.com/datasheets/ap02001.pdf>.
  4. Diodes Inc.'s “Green” policy can be found on our website at [http://www.diodes.com/products/lead\\_free/index.php](http://www.diodes.com/products/lead_free/index.php)
  5. Short duration pulse test used to minimize self-heating effect.

SBR is a registered trademark of Diodes Incorporated.

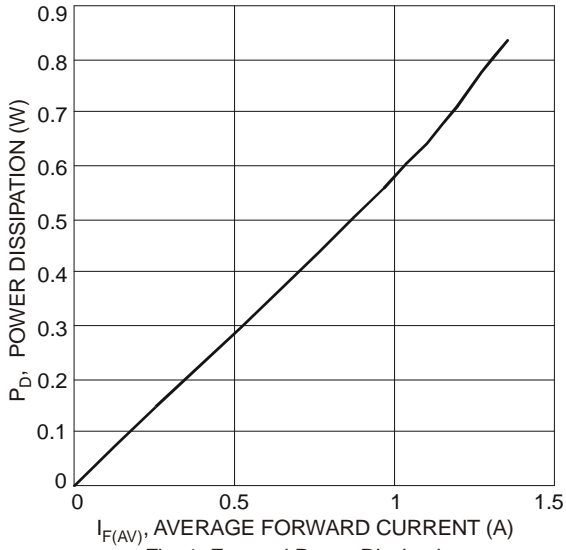

Fig. 1 Forward Power Dissipation

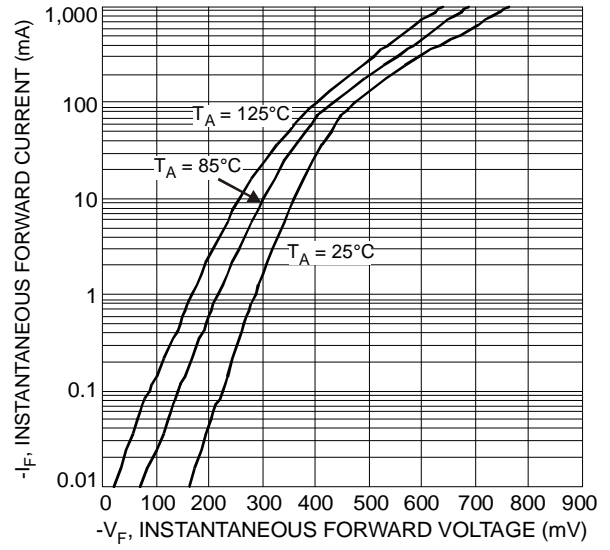

Fig. 2 Typical Forward Characteristics

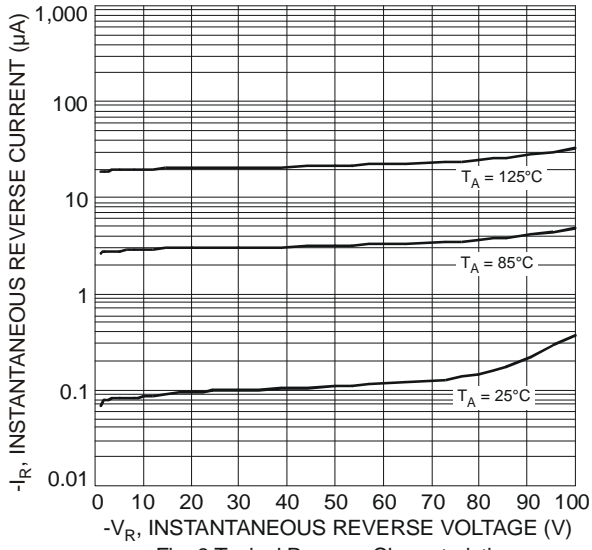

Fig. 3 Typical Reverse Characteristics

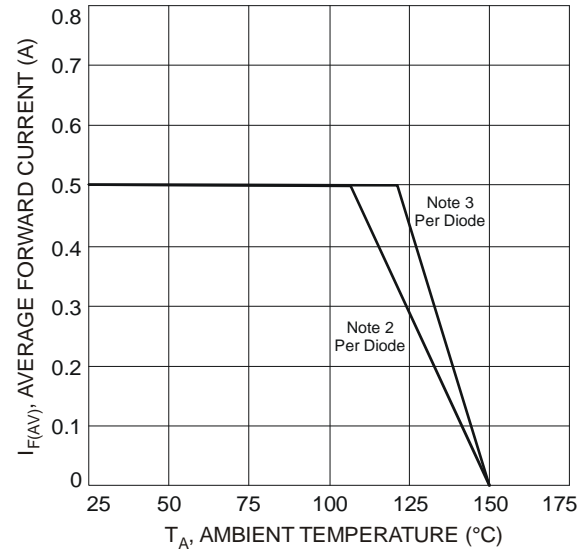

Fig. 4 Forward Current Derating Curve

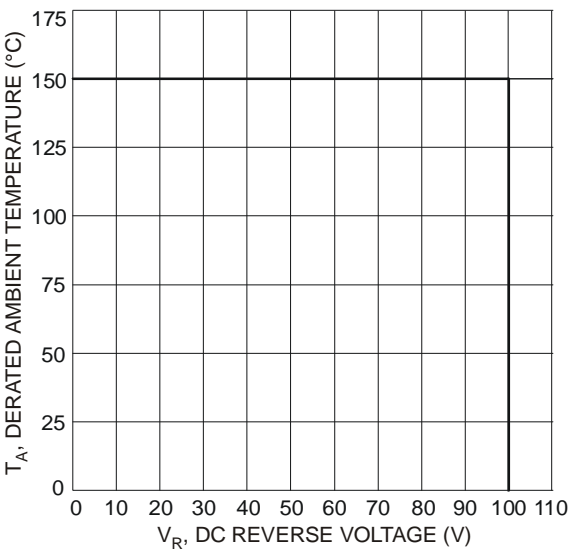

Fig. 5 Operating Temperature Derating

SBR is a registered trademark of Diodes Incorporated.

## Ordering Information (Note 6)

Part Number	Case	Packaging
SBR05M100BLP-7	DFN3030-4	3000/Tape & Reel

Notes: 6. For packaging details, go to our website at <http://www.diodes.com/datasheets/ap02007.pdf>.

## Marking Information

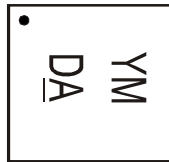

DA = Product Type Marking Code  
 YM = Date Code Marking  
 Y = Year (ex: U = 2007)  
 M = Month (ex: 9 = September)

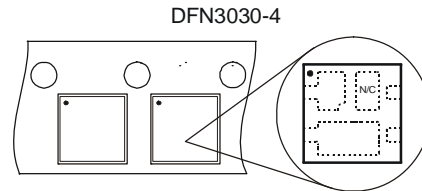

### Date Code Key

Year	2007	2008	2009	2010	2011	2012	2013	2014	2015
Code	U	V	W	X	Y	Z	A	B	C

Month	Jan	Feb	Mar	Apr	May	Jun	Jul	Aug	Sep	Oct	Nov	Dec
Code	1	2	3	4	5	6	7	8	9	O	N	D

## Package Outline Dimensions

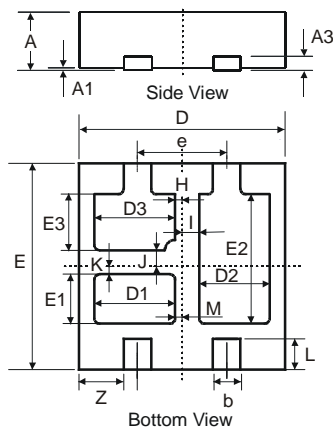

DFN3030-4			
Dim	Min	Max	Typ
A	0.57	0.63	0.60
A1	0	0.05	0.02
A3	-	-	0.15
b	0.35	0.45	0.40
D	2.90	3.10	3.00
D1	1.075	1.275	1.175
D2	0.925	1.125	1.025
D3	1.075	1.275	1.175
E	2.90	3.10	3.00
e	-	-	1.30
E1	0.615	0.815	0.715
E2	1.78	1.98	1.88
E3	0.715	0.915	0.815
H	0.05	0.15	0.10
I	0.20	0.30	0.25
J	0.185	0.285	0.235
K	0.065	0.165	0.115
L	0.30	0.60	0.45
M	0.05	0.15	0.10
Z	-	-	0.65
All Dimensions in mm			

**Suggested Pad Layout**

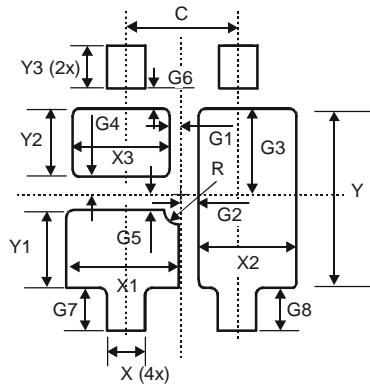

Dimensions	Value (in mm)
C	1.300
G1	0.100
G2	0.150
G3	0.830
G4	0.115
G5	0.135
G6	0.170
G7	0.500
G8	0.500
R	0.150
X	0.500
X1	1.375
X2	1.225
X3	1.175
Y	1.980
Y1	1.015
Y2	0.715
Y3	0.650

**IMPORTANT NOTICE**

DIODES INCORPORATED MAKES NO WARRANTY OF ANY KIND, EXPRESS OR IMPLIED, WITH REGARDS TO THIS DOCUMENT, INCLUDING, BUT NOT LIMITED TO, THE IMPLIED WARRANTIES OF MERCHANTABILITY AND FITNESS FOR A PARTICULAR PURPOSE (AND THEIR EQUIVALENTS UNDER THE LAWS OF ANY JURISDICTION).

Diodes Incorporated and its subsidiaries reserve the right to make modifications, enhancements, improvements, corrections or other changes without further notice to this document and any product described herein. Diodes Incorporated does not assume any liability arising out of the application or use of this document or any product described herein; neither does Diodes Incorporated convey any license under its patent or trademark rights, nor the rights of others. Any Customer or user of this document or products described herein in such applications shall assume all risks of such use and will agree to hold Diodes Incorporated and all the companies whose products are represented on Diodes Incorporated website, harmless against all damages.

Diodes Incorporated does not warrant or accept any liability whatsoever in respect of any products purchased through unauthorized sales channel. Should Customers purchase or use Diodes Incorporated products for any unintended or unauthorized application, Customers shall indemnify and hold Diodes Incorporated and its representatives harmless against all claims, damages, expenses, and attorney fees arising out of, directly or indirectly, any claim of personal injury or death associated with such unintended or unauthorized application.

Products described herein may be covered by one or more United States, international or foreign patents pending. Product names and markings noted herein may also be covered by one or more United States, international or foreign trademarks.

**LIFE SUPPORT**

Diodes Incorporated products are specifically not authorized for use as critical components in life support devices or systems without the express written approval of the Chief Executive Officer of Diodes Incorporated. As used herein:

- A. Life support devices or systems are devices or systems which:
  - 1. are intended to implant into the body, or
  - 2. support or sustain life and whose failure to perform when properly used in accordance with instructions for use provided in the labeling can be reasonably expected to result in significant injury to the user.
- B. A critical component is any component in a life support device or system whose failure to perform can be reasonably expected to cause the failure of the life support device or to affect its safety or effectiveness.

Customers represent that they have all necessary expertise in the safety and regulatory ramifications of their life support devices or systems, and acknowledge and agree that they are solely responsible for all legal, regulatory and safety-related requirements concerning their products and any use of Diodes Incorporated products in such safety-critical, life support devices or systems, notwithstanding any devices- or systems-related information or support that may be provided by Diodes Incorporated. Further, Customers must fully indemnify Diodes Incorporated and its representatives against any damages arising out of the use of Diodes Incorporated products in such safety-critical, life support devices or systems.

Copyright © 2010, Diodes Incorporated

[www.diodes.com](http://www.diodes.com)

SBR is a registered trademark of Diodes Incorporated.