

ST03-43F1

43V

特長

- 1 Wクラス
- 小型SMD
- 車載用途も対応可能

Feature

- 1W Class
- Small SMD
- Available for automotive use

■ 外観図 OUTLINE

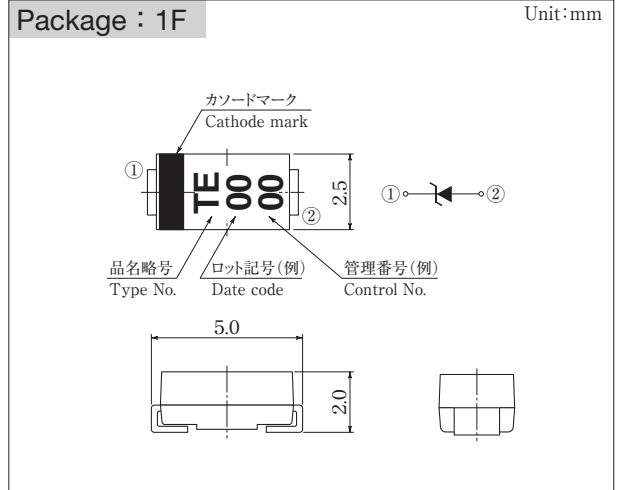

外形図については新電元Webサイトをご参照下さい。捺印表示については捺印仕様をご確認下さい。

For details of the outline dimensions, refer to our web site. As for the marking, refer to the specification "Marking, Terminal Connection".

■ 定格表 RATINGS

● 絶対最大定格 Absolute Maximum Ratings (指定のない場合は $T_l = 25^\circ\text{C}$ / unless otherwise specified)

項目 Item	記号 Symbol	条件 Conditions	規格値 Ratings	単位 Unit
保存温度 Storage Temperature	T_{stg}		- 55 ~ 175	$^\circ\text{C}$
接合部温度 Operating Junction Temperature	T_j		150	$^\circ\text{C}$
せん頭サージ逆電流 Maximum Surge Reverse Current	I_{RSM}	10/1000 μs 非繰り返し 10/1000 μs Non-repetitive	5	A
せん頭サージ逆電力 Maximum Surge Reverse Power	P_{RSM}	10/1000 μs 非繰り返し 10/1000 μs Non-repetitive	300	W
連続印加電圧 Maximum Reverse Voltage	V_{RM}		33	V

● 電氣的・熱的特性 Electrical Characteristics (指定のない場合は $T_l = 25^\circ\text{C}$ / unless otherwise specified)

動作開始電圧 Breakdown Voltage	V_{BR}	$I_R = 1\text{mA}$	MIN 40 MAX 45	V
逆電流 Reverse Current	I_R	$V_R = 33\text{V}$, パルス測定 Pulse measurement	MAX 5.0	μA
熱抵抗 Thermal Resistance	θ_{jl}	接合部・リード間, プリント基板実装 Junction to lead, On glass-epoxy substrate	MAX 23	$^\circ\text{C}/\text{W}$
	θ_{ja}	接合部・周囲間, プリント基板実装 Junction to ambient, On glass-epoxy substrate	MAX 157	

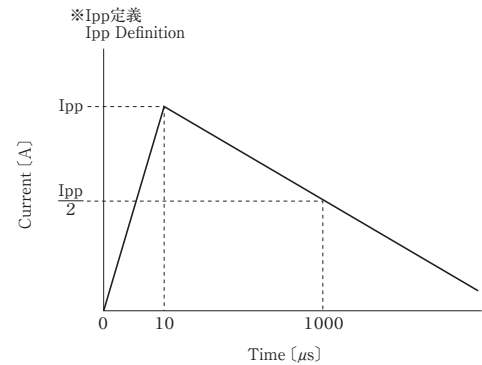

■特性図 CHARACTERISTIC DIAGRAMS

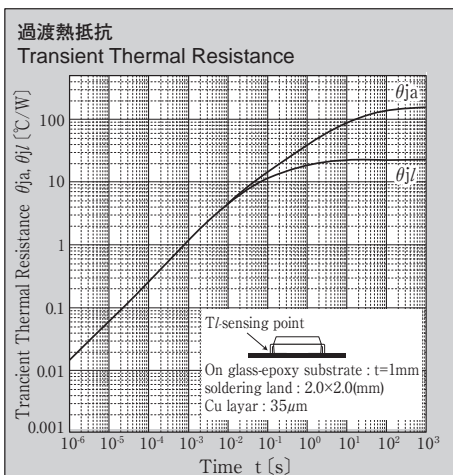
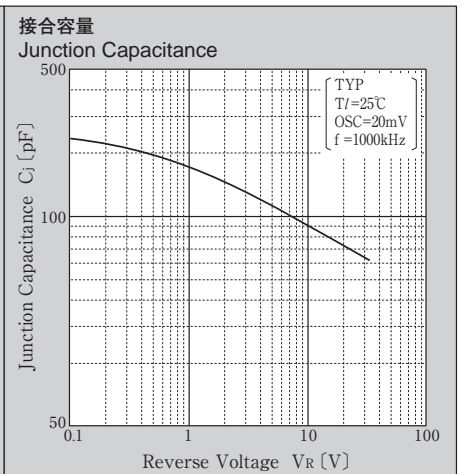
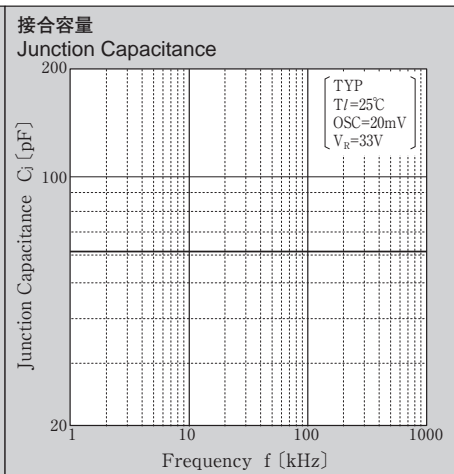
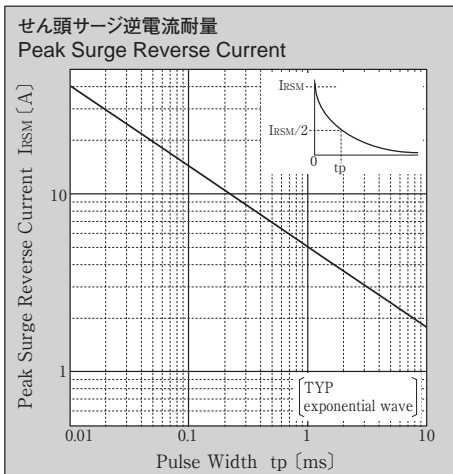
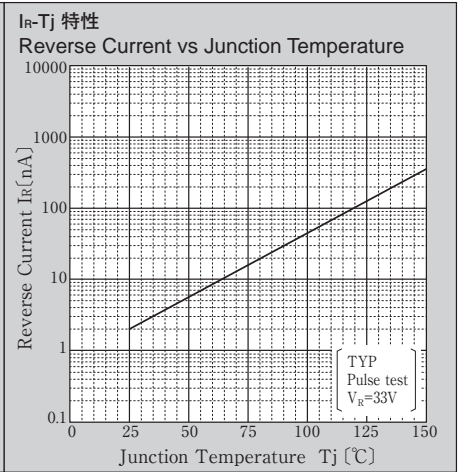
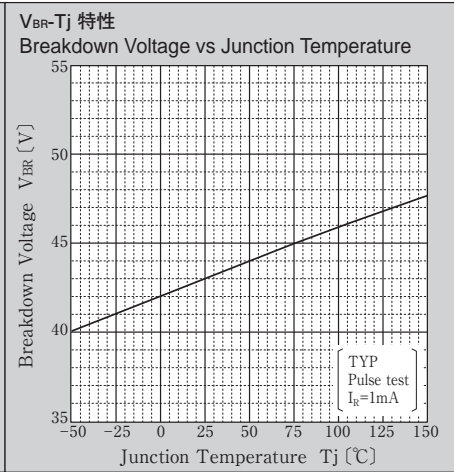
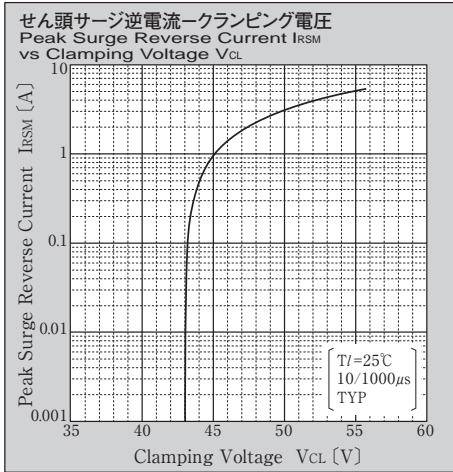

* Sine waveは50Hzで測定しています。
* 50Hz sine wave is used for measurements.

ご注意

1. ご採用に際しては、別途仕様書をご請求の上、ご確認をお願いいたします。
2. 本資料に記載されている当社製品の品質水準は、一般的な信頼度が要求される標準用途を意図しています。その製品の故障や誤動作が直接生命や人体に影響を及ぼすような極めて高い品質、信頼度を要求される特別、特定用途の機器、装置にご使用の場合には必ず事前に当社へご連絡の上、確認を得て下さい。当社の製品の品質水準は以下のように分類しております。
 - 【標準用途】
コンピュータ、OA 等の事務機器、通信用端末機器、計測器、AV 機器、アミューズメント機器、家電、工作機器、パーソナル機器、産業用機器等
 - 【特別用途】
輸送機器(車載、船舶等)、基幹用通信機器、交通信号機器、防災/防犯機器、各種安全機器、医療機器等
 - 【特定用途】
原子力制御システム、航空機器、航空宇宙機器、海底中継機器、生命維持のための装置、システム等
3. 当社は品質と信頼性の向上に絶えず努めていますが、必要に応じ、安全性を考慮した冗長設計、延焼防止設計、誤動作防止設計等の手段により結果として人身事故、火災事故、社会的な損害等が防止できるようご検討下さい。
4. 本資料に記載されている内容は、製品改良などのためお断りなしに変更することがありますのでご了承下さい。製品のご購入に際しましては事前に当社または特約店へ最新の情報をご確認下さい。
5. 本資料の使用によって起因する損害または特許権その他権利の侵害に関しては、当社は一切その責任を負いません。
6. 本資料によって第三者または当社の特許権その他権利の実施に対する保証または実施権の許諾を行うものではありません。
7. 本資料に記載されている製品が、外国為替及び外国貿易管理法に基づき規制されている場合、輸出には同法に基づく日本国政府の輸出許可が必要です。
8. 本資料の一部または全部を当社に無断で転載または複製することを堅くお断りいたします。

Notes

1. If you wish to use any such product, please be sure to refer to the specifications issued by Shindengen.
2. All products described or contained herein are designed with a quality level intended for use in standard applications requiring an ordinary level of reliability. If these products are to be used in equipment or devices for special or specific applications requiring an extremely high grade of quality or reliability in which failures or malfunctions of products may directly affect human life or health, a local Shindengen office must be contacted in advance to confirm that the intended use of the product is appropriate. Shindengen products are grouped into the following three applications according to the quality grade.

[Standard applications]

Computers, office automation and other office equipment, communication terminals, test and measurement equipment, audio/visual equipment, amusement equipment, consumer electronics, machine tools, personal electronic equipment, industrial equipment, etc.

[Special applications]

Transportation equipment (vehicles, ships, etc.), trunk-line communication equipment, traffic signal control systems, anti-disaster/crime systems, safety equipment, medical equipment, etc.

[Specific applications]

Nuclear reactor control systems, aircraft, aerospace equipment, submarine repeaters, life support equipment and systems, etc.

3. Although Shindengen continuously endeavors to enhance the quality and reliability of its products, customers are advised to consider and take safety measures in their design, such as redundancy, fire containment and anti-failure, so that personal injury, fires, or societal damages can be prevented.
4. Please note that all information described or contained herein is subject to change without notice due to product upgrades and other reasons. When buying Shindengen products, please contact the Company's offices or distributors to obtain the latest information.
5. Shindengen shall not bear any responsibility with regards to damages or infringement of any third-party patent rights and other intellectual property rights incurred due to the use of information on this website.
6. The information and materials on this website neither warrant the use of Shindengen's or any third party's patent rights and other intellectual property rights, nor grant license to such rights.
7. In the event that any product described or contained herein falls under the category of strategic products controlled under the Foreign Exchange and Foreign Trade Control Law of Japan, exporting of such products shall require an export license from the Japanese government in accordance with the above law.
8. No reprinting or reproduction of the materials on this website, either in whole or in part, is permitted without proper authorization from Shindengen.