

Thyristor Module

$$I_{TRMS} = 2x 400 A$$

$$I_{TAVM} = 2x 240 A$$

$$V_{RRM} = 2400 V$$

V_{RSM}	V_{RRM}	Type
V_{DSM}	V_{DRM}	
V	V	
2500	2400	MCC 224-24io1

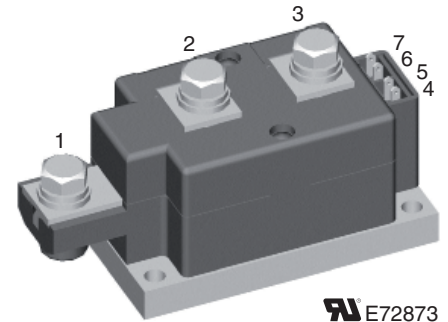
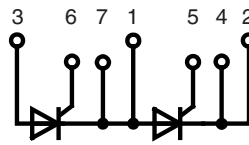

Symbol	Conditions	Maximum Ratings	
I_{TRMS}	$T_{VJ} = T_{VJM}$	400	A
I_{TAVM}	$T_C = 85^{\circ}C; 180^{\circ}$ sine	240	A
I_{TSM}	$T_{VJ} = 45^{\circ}C; t = 10$ ms (50 Hz)	8000	A
	$V_R = 0; t = 8.3$ ms (60 Hz)	8500	A
	$T_{VJ} = T_{VJM}; t = 10$ ms (50 Hz)	7000	A
	$V_R = 0; t = 8.3$ ms (60 Hz)	7500	A
I^2t	$T_{VJ} = 45^{\circ}C; t = 10$ ms (50 Hz)	320 000	A ² s
	$V_R = 0; t = 8.3$ ms (60 Hz)	303 000	A ² s
	$T_{VJ} = T_{VJM}; t = 10$ ms (50 Hz)	245 000	A ² s
	$V_R = 0; t = 8.3$ ms (60 Hz)	240 000	A ² s
$(di/dt)_{cr}$	$T_{VJ} = T_{VJM};$ repetitive, $I_T = 750$ A	100	A/ μ s
	$f = 50$ Hz; $t_p = 200$ μ s; $V_D = 2/3 V_{DRM};$ $I_G = 1$ A; $di_G/dt = 1$ A/ μ s	500	A/ μ s
$(dv/dt)_{cr}$	$T_{VJ} = T_{VJM}; V_D = 2/3 V_{DRM};$ $R_{GK} = \infty;$ method 1 (linear voltage rise)	1000	V/ μ s
P_{GM}	$T_{VJ} = T_{VJM}; t_p = 30$ μ s	120	W
	$I_T = I_{T(AV)M}; t_p = 500$ μ s	60	W
P_{GAV}		20	W
V_{RGM}		10	V
T_{VJ}		-40...+130	$^{\circ}C$
T_{VJM}		130	$^{\circ}C$
T_{stg}		-40...+125	$^{\circ}C$
V_{ISOL}	50/60 Hz, RMS $t = 1$ min	3000	V~
	$I_{ISOL} \leq 1$ mA $t = 1$ s	3600	V~
M_d	Mounting torque (M6)	4.5 - 7	Nm
	Terminal connection torque (M8)	11 - 13	Nm
Weight	Typical including screws	750	g

Data according to IEC 60747 and refer to a single diode unless otherwise stated.

Features

- International standard package
- **Direct Copper Bonded** Al₂O₃-ceramic with copper base plate
- Planar passivated chips
- Isolation voltage 3600 V~
- UL registered, E 72873
- Keyed gate/cathode twin pins

Applications

- Motor control, softstarter
- Power converter
- Heat and temperature control for industrial furnaces and chemical processes
- Lighting control
- Solid state switches

Advantages

- Simple mounting
- Improved temperature and power cycling
- Reduced protection circuits

Symbol	Conditions	Characteristic Values	
		typ.	max.
I_{RRM}, I_{DRM}	$V_R / V_D = V_{RRM} / V_{DRM}$	$T_{VJ} = T_{VJM}$	40 mA
V_T, V_F	$I_T, I_F = 600$ A	$T_{VJ} = 25^\circ\text{C}$	1.4 V
V_{T0}	For power-loss calculations only		0.8 V
r_t		$T_{VJ} = T_{VJM}$	0.76 mΩ
V_{GT}	$V_D = 6$ V	$T_{VJ} = 25^\circ\text{C}$	2 V
		$T_{VJ} = -40^\circ\text{C}$	3 V
I_{GT}	$V_D = 6$ V	$T_{VJ} = 25^\circ\text{C}$	150 mA
		$T_{VJ} = -40^\circ\text{C}$	220 mA
V_{GD}	$V_D = 2/3 V_{DRM}$	$T_{VJ} = T_{VJM}$	0.25 V
I_{GD}			10 mA
I_L	$t_p = 30 \mu\text{s}; V_D = 6$ V $I_G = 0.45$ A; $di_G/dt = 0.45$ A/ μs	$T_{VJ} = 25^\circ\text{C}$	200 mA
I_H	$V_D = 6$ V; $R_{GK} = \infty$;	$T_{VJ} = 25^\circ\text{C}$	150 mA
t_{gd}	$V_D = 1/2 V_{DRM}$ $I_G = 1$ A; $di_G/dt = 1$ A/ μs	$T_{VJ} = 25^\circ\text{C}$	2 μs
t_q	$V_D = 2/3 V_{DRM}$ $dv/dt = 50$ V/ μs ; $-di/dt = 10$ A/ μs $I_T = 300$ A; $V_R = 100$ V; $t_p = 200 \mu\text{s}$	$T_{VJ} = T_{VJM}$	200 μs
Q_S	$I_T = 300$ A; $-di/dt = 50$ A/ μs	$T_{VJ} = T_{VJM}$	550 μC
I_{RM}			235 A
R_{thJC}	per thyristor; DC current per module	other values	0.139 K/W 0.07 K/W
R_{thJK}	per thyristor; DC current per module	see Fig. 8/9	0.179 K/W 0.09 K/W
d_S	Creeping distance on surface		12.7 mm
d_A	Creepage distance in air		9.6 mm
a	Maximum allowable acceleration		50 m/s ²

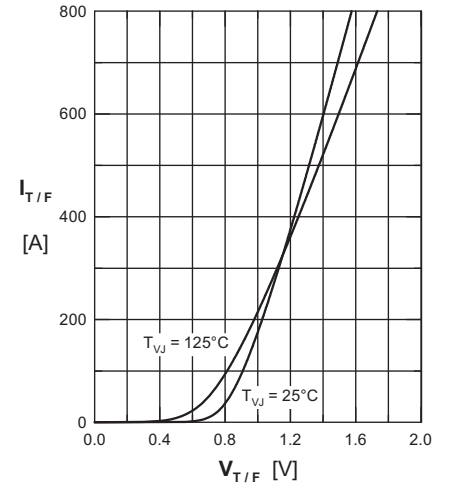

Fig. 1 Forward characteristics

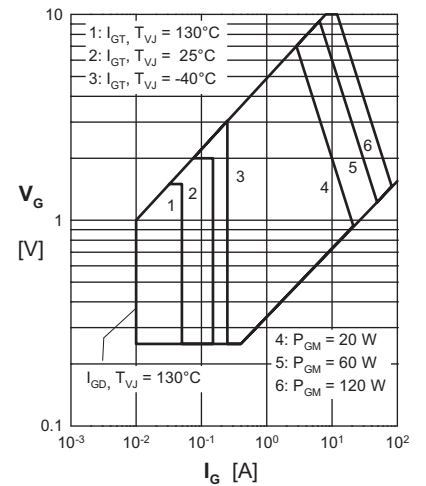

Fig. 2 Gate trigger characteristics

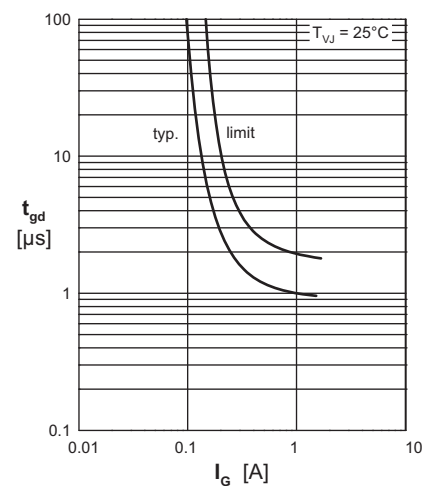
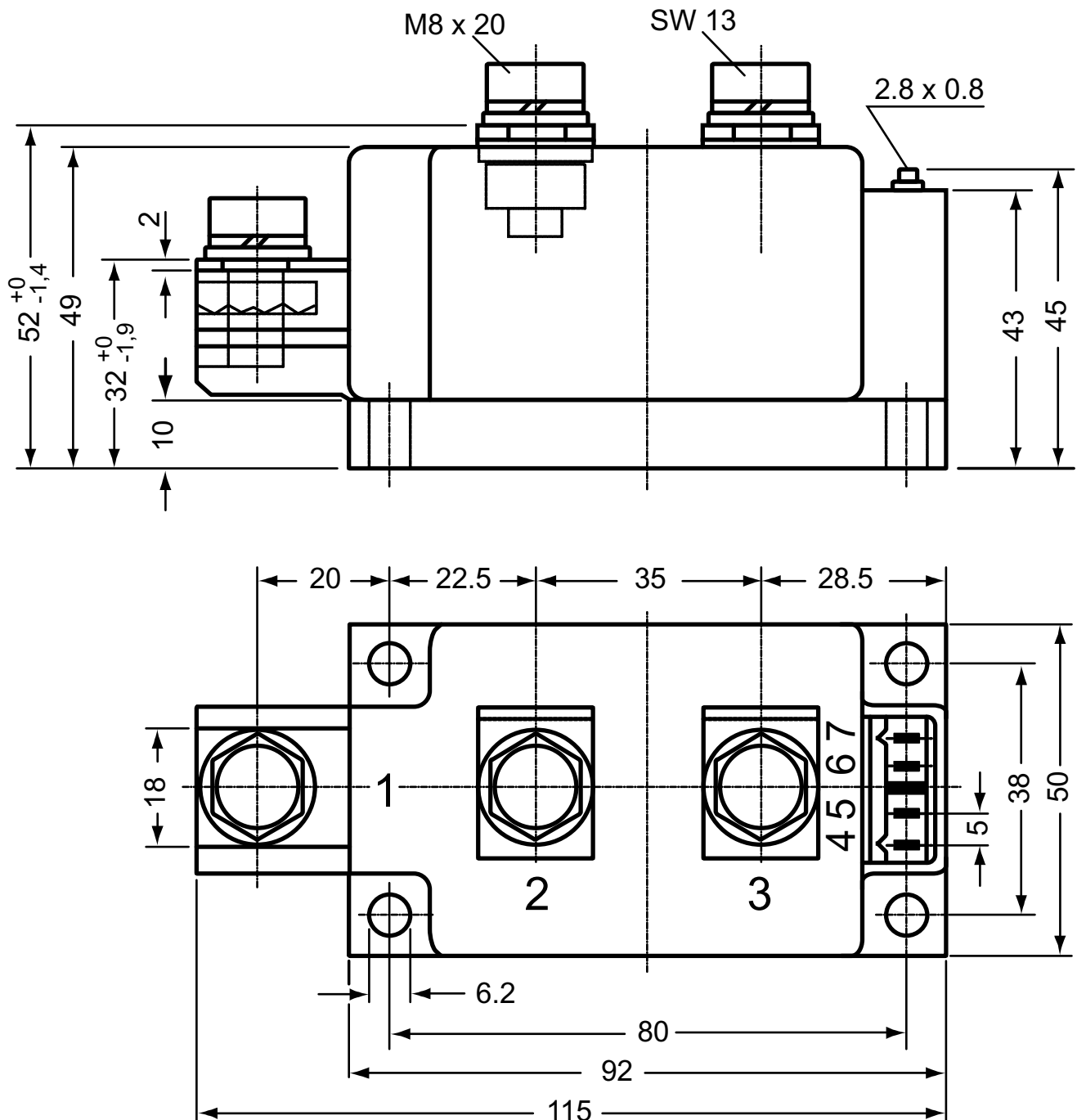

Fig. 3 Gate trigger delay time

Dimensions in mm (1 mm = 0.0394")

Optional accessories for modules

Keyed gate/cathode twin plugs with wire length = 350 mm, gate = white, cathode = red

 Type ZY 180L (L = Left for pin pair 4/5) } UL 758, style 3751
 Type ZY 180R (R = Right for pin pair 6/7) }

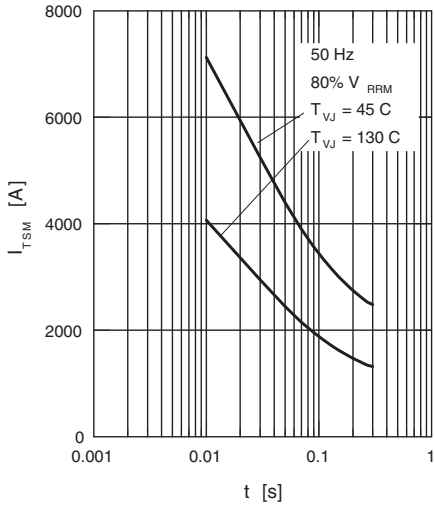

Fig. 4 Surge overload current
 I_{TSM} : Crest value, t : duration

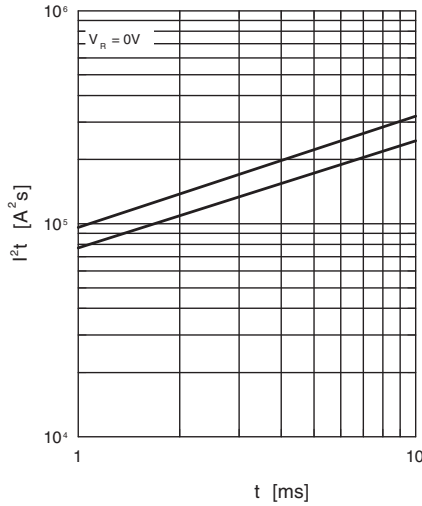

Fig. 5 i^2t versus time (1-10 ms)

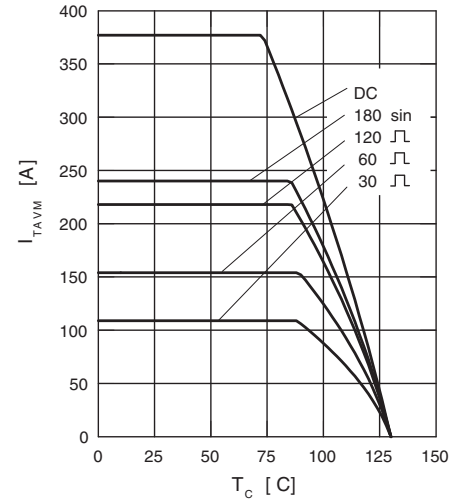

Fig. 5a Maximum forward current at case temperature

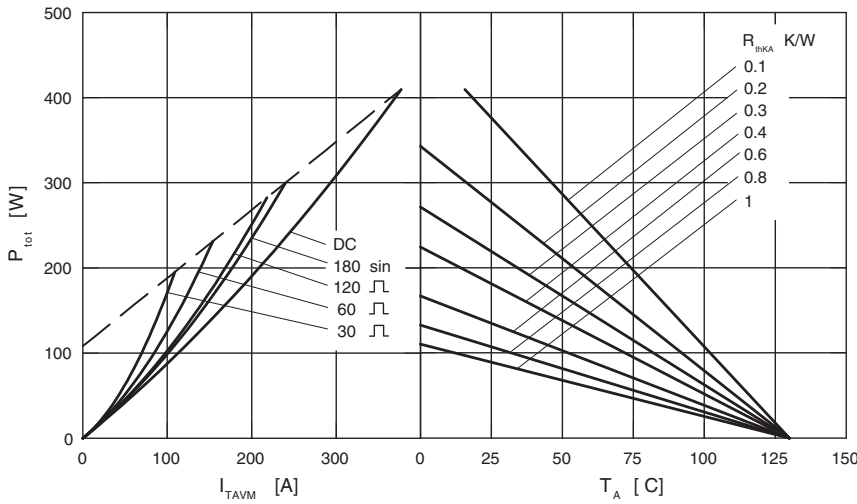

Fig. 6 Power dissipation vs. on-state current and ambient temperature

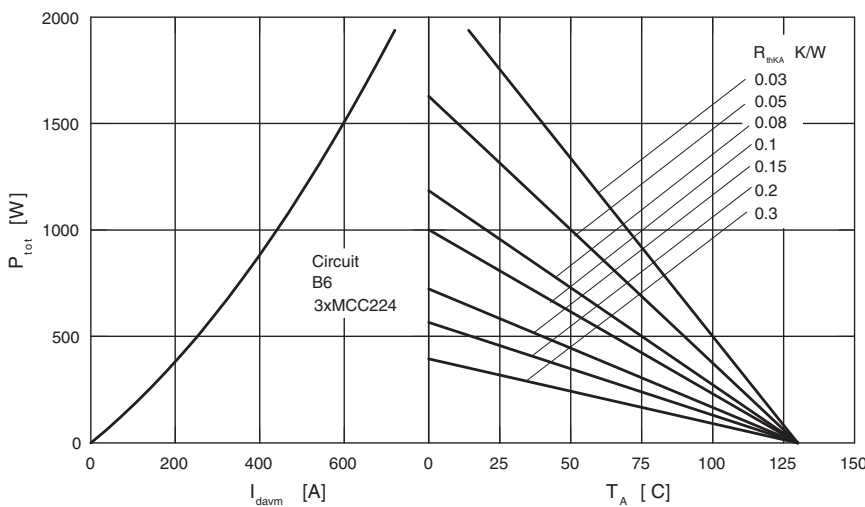

Fig. 7 Three phase rectifier bridge:
Power dissipation vs. direct output current and ambient temperature

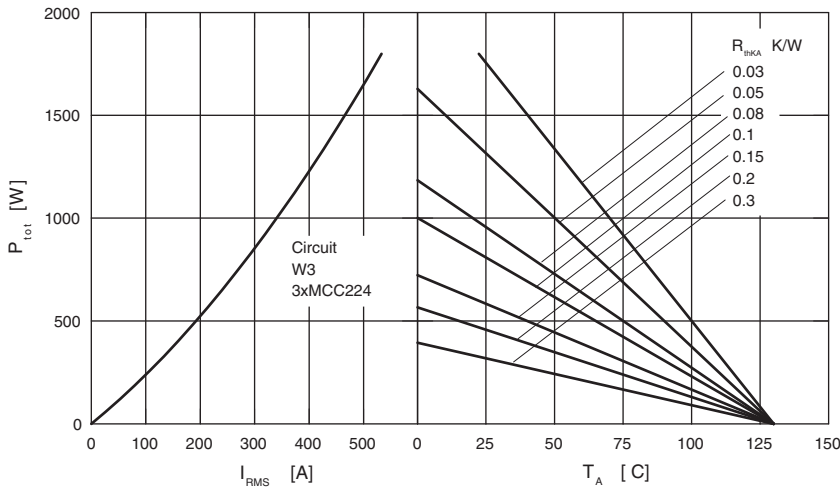

Fig. 8 3~ AC-controller: Power dissipation vs. RMS output current & ambient temperature

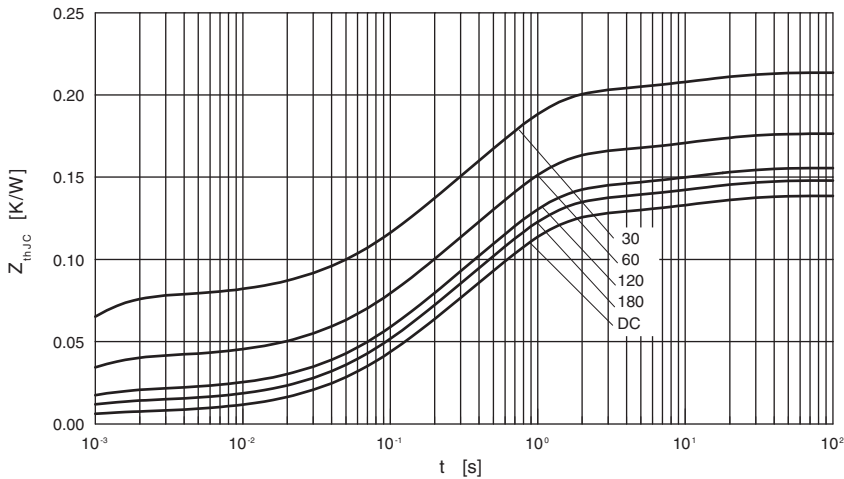

Fig. 9 Transient thermal impedance junction to case

R_{thJC} for various conduction angles d:

d	R_{thJC} (K/W)
DC	0.139
180°	0.148
120°	0.156
60°	0.176
30°	0.214

Constants for Z_{thJC} calculation:

i	R_{thi} (K/W)	t_i (s)
1	0.0067	0.00054
2	0.0358	0.098
3	0.0832	0.54
4	0.0129	12

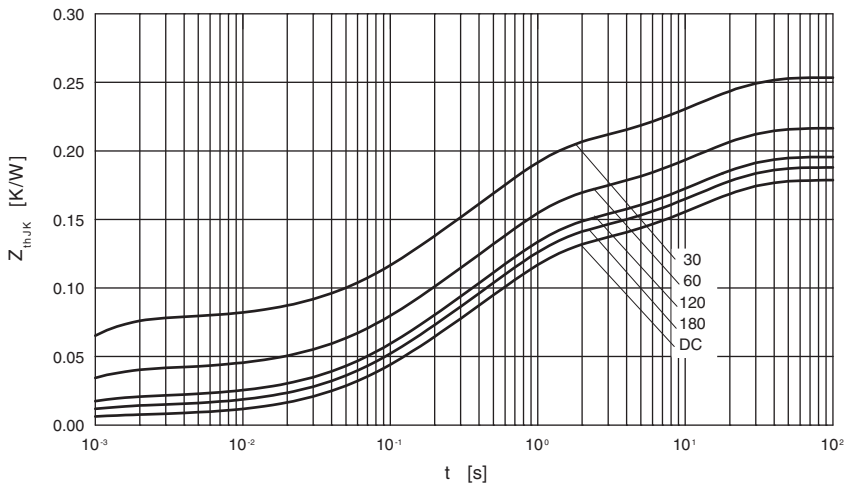

Fig. 10 Transient thermal impedance junction to heatsink

R_{thJK} for various conduction angles d:

d	R_{thJK} (K/W)
DC	0.179
180°	0.188
120°	0.196
60°	0.216
30°	0.256

Constants for Z_{thJK} calculation:

i	R_{thi} (K/W)	t_i (s)
1	0.0067	0.001
2	0.0358	0.08
3	0.0832	0.20
4	0.0129	1.0
5	0.04	