

Thyristor Modules

Thyristor/Diode Modules

$$I_{TRMS} = 2x 400 A$$

$$I_{TAVM} = 2x 240 A$$

$$V_{RRM} = 2000/2200 V$$

V_{RSM}	V_{RRM}	Type
V_{DSM}	V_{DRM}	
V	V	
2100	2000	MCC 224-20io1 MCD 224-20io1
2300	2200	MCC 224-22io1 MCD 224-22io1

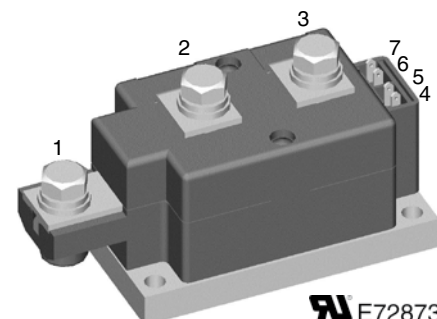
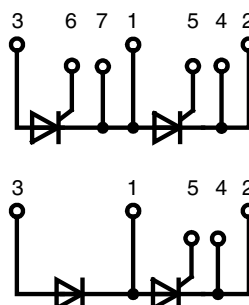

Symbol	Conditions	Maximum Ratings
I_{TRMS}	$T_{VJ} = T_{VJM}$	400 A
I_{TAVM}	$T_C = 85^{\circ}C$; 180° sine	240 A
I_{TSM}	$T_{VJ} = 45^{\circ}C$; $t = 10$ ms (50 Hz)	8000 A
	$V_R = 0$; $t = 8.3$ ms (60 Hz)	8500 A
	$T_{VJ} = T_{VJM}$; $t = 10$ ms (50 Hz)	7000 A
	$V_R = 0$; $t = 8.3$ ms (60 Hz)	7500 A
I^2t	$T_{VJ} = 45^{\circ}C$; $t = 10$ ms (50 Hz)	320 000 A ² s
	$V_R = 0$; $t = 8.3$ ms (60 Hz)	303 000 A ² s
	$T_{VJ} = T_{VJM}$; $t = 10$ ms (50 Hz)	245 000 A ² s
	$V_R = 0$; $t = 8.3$ ms (60 Hz)	240 000 A ² s
$(di/dt)_{cr}$	$T_{VJ} = T_{VJM}$; repetitive, $I_T = 750$ A	100 A/ μ s
	$f = 50$ Hz; $t_p = 200$ μ s; $V_D = 2/3 V_{DRM}$; $I_G = 1$ A; $di_G/dt = 1$ A/ μ s	500 A/ μ s
$(dv/dt)_{cr}$	$T_{VJ} = T_{VJM}$; $V_D = 2/3 V_{DRM}$; $R_{GK} = \infty$; method 1 (linear voltage rise)	1000 V/ μ s
P_{GM}	$T_{VJ} = T_{VJM}$; $t_p = 30$ μ s	120 W
	$I_T = I_{T(AV)M}$; $t_p = 500$ μ s	60 W
P_{GAV}		20 W
V_{RGM}		10 V
T_{VJ}		-40...+130 °C
T_{VJM}		130 °C
T_{stg}		-40...+125 °C
V_{ISOL}	50/60 Hz, RMS $t = 1$ min	3000 V~
	$I_{ISOL} \leq 1$ mA $t = 1$ s	3600 V~
M_d	Mounting torque (M6)	4.5 - 7 Nm
	Terminal connection torque (M8)	11 - 13 Nm
Weight	Typical including screws	750 g

Features

- International standard package
- Direct Copper Bonded Al₂O₃-ceramic base plate
- Planar passivated chips
- Isolation voltage 3600 V~
- UL registered, E 72873
- Keyed gate/cathode twin pins

Applications

- Motor control, softstarter
- Power converter
- Heat and temperature control for industrial furnaces and chemical processes
- Lighting control
- Solid state switches

Advantages

- Simple mounting
- Improved temperature and power cycling
- Reduced protection circuits

Data according to IEC 60747 and refer to a single diode unless otherwise stated.

Symbol	Conditions	Characteristic Values	
		typ.	max.
I_{RRM}, I_{DRM}	$V_R / V_D = V_{RRM} / V_{DRM}$	$T_{VJ} = T_{VJM}$	40 mA
V_T	$I_T = 600$ A	$T_{VJ} = 25^\circ\text{C}$	1.4 V
V_{T0}	For power-loss calculations only		0.8 V
r_t		$T_{VJ} = T_{VJM}$	0.76 mΩ
V_{GT}	$V_D = 6$ V	$T_{VJ} = 25^\circ\text{C}$ $T_{VJ} = -40^\circ\text{C}$	2 V 3 V
I_{GT}	$V_D = 6$ V	$T_{VJ} = 25^\circ\text{C}$ $T_{VJ} = -40^\circ\text{C}$	150 mA 220 mA
V_{GD} I_{GD}	$V_D = \frac{2}{3} V_{DRM}$	$T_{VJ} = T_{VJM}$	0.25 V 10 mA
I_L	$t_p = 30 \mu\text{s}; V_D = 6$ V $I_G = 0.45$ A; $di_G/dt = 0.45$ A/ μs	$T_{VJ} = 25^\circ\text{C}$	200 mA
I_H	$V_D = 6$ V; $R_{GK} = \infty$;	$T_{VJ} = 25^\circ\text{C}$	150 mA
t_{gd}	$V_D = \frac{1}{2} V_{DRM}$ $I_G = 1$ A; $di_G/dt = 1$ A/ μs	$T_{VJ} = 25^\circ\text{C}$	2 μs
t_q	$V_D = \frac{2}{3} V_{DRM}$ $dv/dt = 50$ V/ μs ; $-di/dt = 10$ A/ μs $I_T = 300$ A; $V_R = 100$ V; $t_p = 200 \mu\text{s}$	$T_{VJ} = T_{VJM}$	200 μs
Q_S I_{RM}	$I_T = 300$ A; $-di/dt = 50$ A/ μs	$T_{VJ} = T_{VJM}$	760 μC 275 A
R_{thJC}	per thyristor; DC current per module		0.139 K/W 0.069 K/W
R_{thJK}	per thyristor; DC current per module		0.179 K/W 0.089 K/W
d_S	Creeping distance on surface		12.7 mm
d_A	Creepage distance in air		9.6 mm
a	Maximum allowable acceleration		50 m/s ²

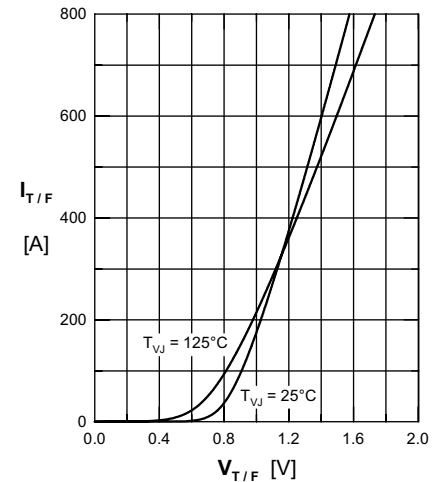

Fig. 1 Forward characteristics

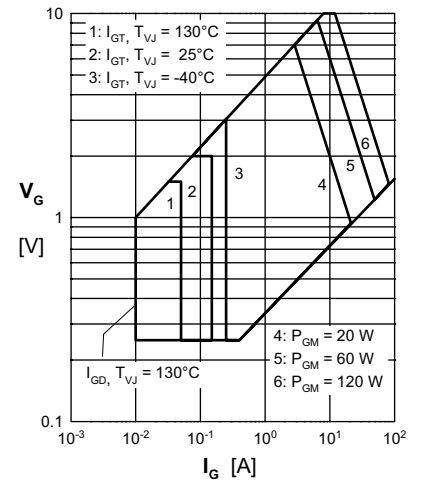

Fig. 2 Gate trigger characteristics

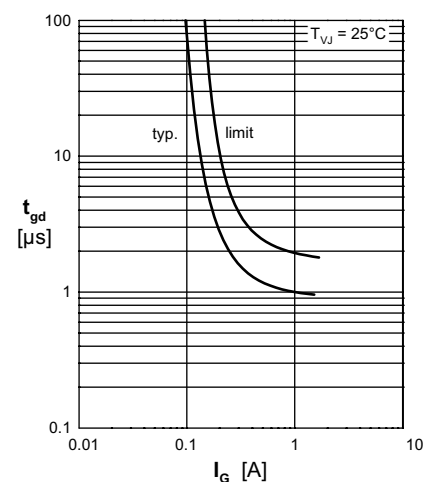
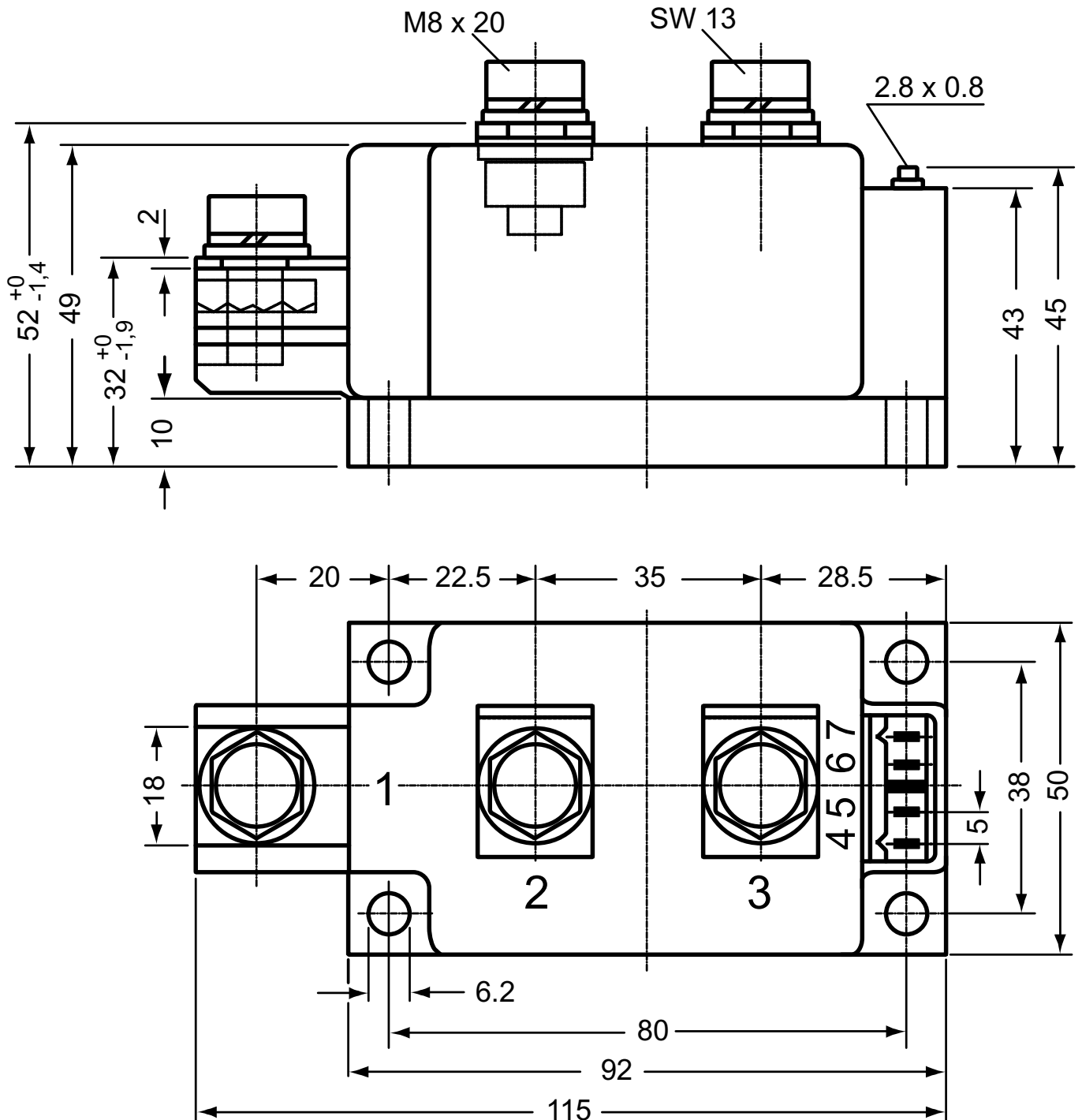

Fig. 3 Gate trigger delay time

Dimensions in mm (1 mm = 0.0394")



Optional accessories for modules

Keyed gate/cathode twin plugs with wire length = 350 mm, gate = white, cathode = red

Type ZY 180L (L = Left for pin pair 4/5)

Type ZY 180R (R = Right for pin pair 6/7) } UL 758, style 3751

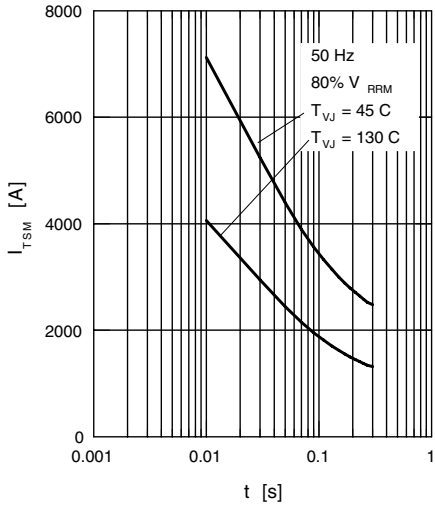

Fig. 4 Surge overload current
 I_{TSM} : Crest value, t : duration

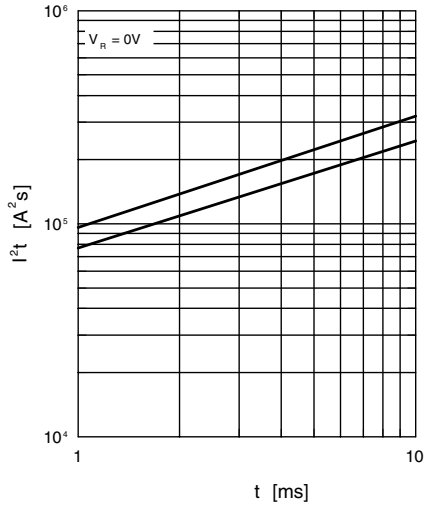

Fig. 5 i^2t versus time (1-10 ms)

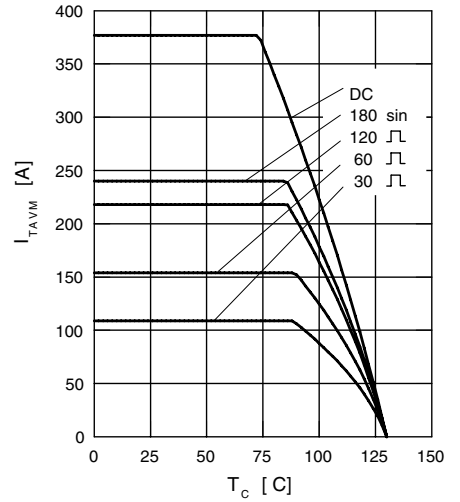

Fig. 5a Maximum forward current at case temperature

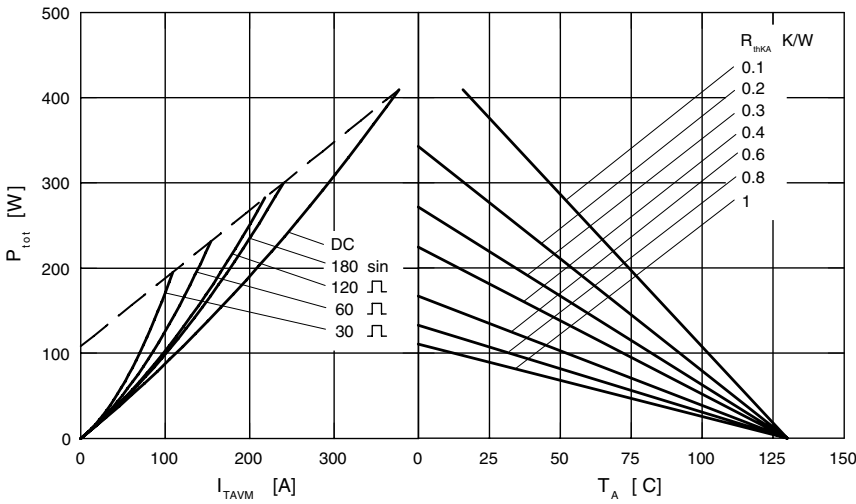

Fig. 6 Power dissipation vs. on-state current and ambient temperature

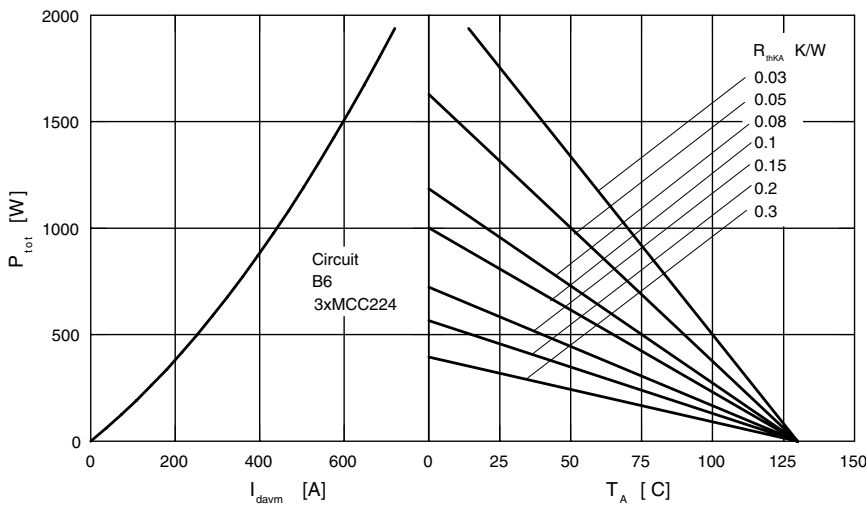

Fig. 7 Three phase rectifier bridge:
Power dissipation vs. direct output current and ambient temperature

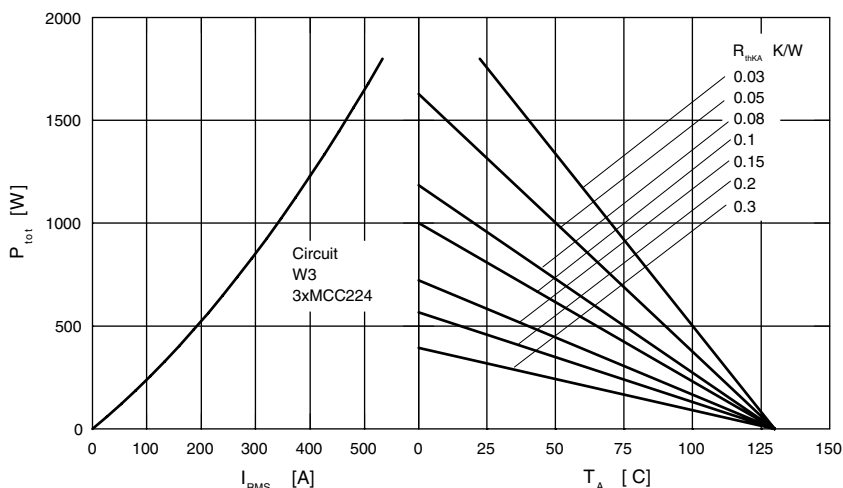

Fig. 8 3~ AC-controller: Power dissipation vs. RMS output current & ambient temperature

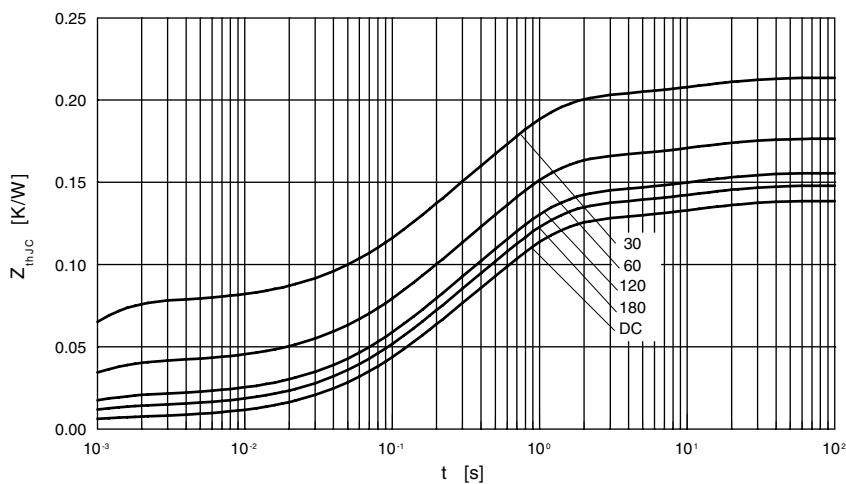

Fig. 9 Transient thermal impedance junction to case

R_{thJC} for various conduction angles d:

d	R_{thJC} (K/W)
DC	0.139
180°	0.148
120°	0.156
60°	0.176
30°	0.214

Constants for Z_{thJC} calculation:

i	R_{thi} (K/W)	t_i (s)
1	0.0067	0.00054
2	0.0358	0.098
3	0.0832	0.54
4	0.0129	12

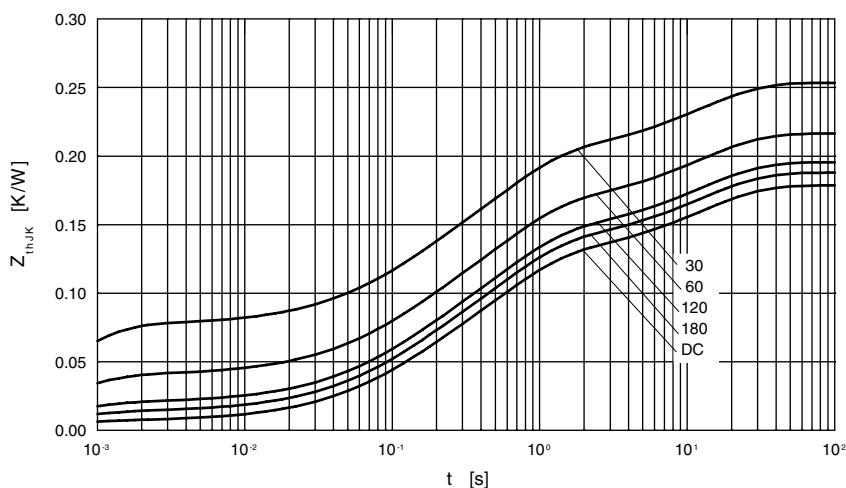

Fig. 10 Transient thermal impedance junction to heatsink

R_{thJK} for various conduction angles d:

d	R_{thJK} (K/W)
DC	0.179
180°	0.188
120°	0.196
60°	0.216
30°	0.256

Constants for Z_{thJK} calculation:

i	R_{thi} (K/W)	t_i (s)
1	0.0067	0.001
2	0.0358	0.08
3	0.0832	0.20
4	0.0129	1.0
5	0.04	