

## Thyristor Module

$$V_{RRM} = 2 \times 1600 \text{ V}$$

$$I_{TAV} = 27 \text{ A}$$

$$V_T = 1.27 \text{ V}$$

Phase leg

Part number

MCC26-16io8B

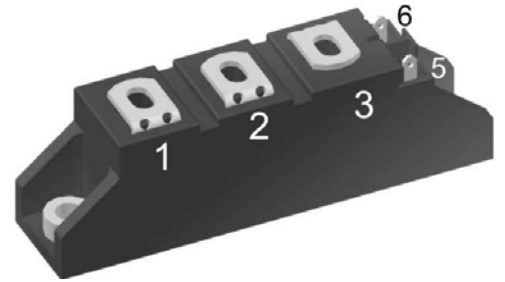

Backside: isolated

 E72873

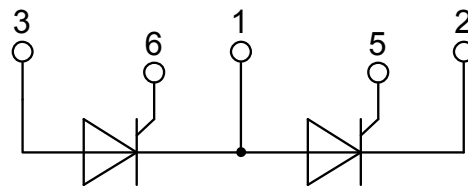

### Features / Advantages:

- Thyristor for line frequency
- Planar passivated chip
- Long-term stability
- Direct Copper Bonded Al<sub>2</sub>O<sub>3</sub>-ceramic

### Applications:

- Line rectifying 50/60 Hz
- Softstart AC motor control
- DC Motor control
- Power converter
- AC power control
- Lighting and temperature control

### Package: TO-240AA

- Isolation Voltage: 3600 V~
- Industry standard outline
- RoHS compliant
- Soldering pins for PCB mounting
- Base plate: DCB ceramic
- Reduced weight
- Advanced power cycling

Thyristor				Ratings			
Symbol	Definition	Conditions	min.	typ.	max.	Unit	
$V_{RSM/DSM}$	max. non-repetitive reverse/forward blocking voltage	$T_{VJ} = 25^{\circ}C$			1700	V	
$V_{RRM/DRM}$	max. repetitive reverse/forward blocking voltage	$T_{VJ} = 25^{\circ}C$			1600	V	
$I_{RD}$	reverse current, drain current	$V_{R/D} = 1600 V$	$T_{VJ} = 25^{\circ}C$		100	$\mu A$	
		$V_{R/D} = 1600 V$	$T_{VJ} = 125^{\circ}C$		3	mA	
$V_T$	forward voltage drop	$I_T = 40 A$	$T_{VJ} = 25^{\circ}C$		1.27	V	
		$I_T = 80 A$			1.64	V	
		$I_T = 40 A$	$T_{VJ} = 125^{\circ}C$		1.27	V	
		$I_T = 80 A$			1.65	V	
$I_{TAV}$	average forward current	$T_C = 85^{\circ}C$	$T_{VJ} = 125^{\circ}C$		27	A	
$I_{T(RMS)}$	RMS forward current	180° sine			50	A	
$V_{T0}$	threshold voltage	} for power loss calculation only	$T_{VJ} = 125^{\circ}C$		0.85	V	
$r_T$	slope resistance				11	m $\Omega$	
$R_{thJC}$	thermal resistance junction to case				0.88	K/W	
$R_{thCH}$	thermal resistance case to heatsink			0.20		K/W	
$P_{tot}$	total power dissipation		$T_C = 25^{\circ}C$		115	W	
$I_{TSM}$	max. forward surge current	$t = 10 ms; (50 Hz), sine$	$T_{VJ} = 45^{\circ}C$		520	A	
		$t = 8,3 ms; (60 Hz), sine$	$V_R = 0 V$		560	A	
		$t = 10 ms; (50 Hz), sine$	$T_{VJ} = 125^{\circ}C$		440	A	
		$t = 8,3 ms; (60 Hz), sine$	$V_R = 0 V$		475	A	
$I^2t$	value for fusing	$t = 10 ms; (50 Hz), sine$	$T_{VJ} = 45^{\circ}C$		1.35	kA <sup>2</sup> s	
		$t = 8,3 ms; (60 Hz), sine$	$V_R = 0 V$		1.31	kA <sup>2</sup> s	
		$t = 10 ms; (50 Hz), sine$	$T_{VJ} = 125^{\circ}C$		970	A <sup>2</sup> s	
		$t = 8,3 ms; (60 Hz), sine$	$V_R = 0 V$		940	A <sup>2</sup> s	
$C_J$	junction capacitance	$V_R = 400 V \quad f = 1 MHz$	$T_{VJ} = 25^{\circ}C$		22	pF	
$P_{GM}$	max. gate power dissipation	$t_p = 30 \mu s$	$T_C = 125^{\circ}C$		10	W	
		$t_p = 300 \mu s$			5	W	
$P_{GAV}$	average gate power dissipation				0.5	W	
$(di/dt)_{cr}$	critical rate of rise of current	$T_{VJ} = 125^{\circ}C; f = 50 Hz$ repetitive, $I_T = 45 A$			150	A/ $\mu s$	
		$t_p = 200 \mu s; di_G/dt = 0.45 A/\mu s;$ $I_G = 0.45 A; V_D = \frac{2}{3} V_{DRM}$ non-repet., $I_T = 27 A$			500	A/ $\mu s$	
$(dv/dt)_{cr}$	critical rate of rise of voltage	$V_D = \frac{2}{3} V_{DRM}$ $R_{GK} = \infty; \text{method 1 (linear voltage rise)}$	$T_{VJ} = 125^{\circ}C$		1000	V/ $\mu s$	
$V_{GT}$	gate trigger voltage	$V_D = 6 V$	$T_{VJ} = 25^{\circ}C$		1.5	V	
			$T_{VJ} = -40^{\circ}C$		1.6	V	
$I_{GT}$	gate trigger current	$V_D = 6 V$	$T_{VJ} = 25^{\circ}C$		100	mA	
			$T_{VJ} = -40^{\circ}C$		200	mA	
$V_{GD}$	gate non-trigger voltage	$V_D = \frac{2}{3} V_{DRM}$	$T_{VJ} = 125^{\circ}C$		0.2	V	
$I_{GD}$	gate non-trigger current				10	mA	
$I_L$	latching current	$t_p = 10 \mu s$	$T_{VJ} = 25^{\circ}C$		450	mA	
		$I_G = 0.45 A; di_G/dt = 0.45 A/\mu s$					
$I_H$	holding current	$V_D = 6 V \quad R_{GK} = \infty$	$T_{VJ} = 25^{\circ}C$		200	mA	
$t_{gd}$	gate controlled delay time	$V_D = \frac{1}{2} V_{DRM}$	$T_{VJ} = 25^{\circ}C$		2	$\mu s$	
		$I_G = 0.45 A; di_G/dt = 0.45 A/\mu s$					
$t_q$	turn-off time	$V_R = 100 V; I_T = 20 A; V_D = \frac{2}{3} V_{DRM}$ $di/dt = 10 A/\mu s; dv/dt = 20 V/\mu s; t_p = 200 \mu s$	$T_{VJ} = 125^{\circ}C$		150	$\mu s$	

Package TO-240AA				Ratings		
Symbol	Definition	Conditions	min.	typ.	max.	Unit
$I_{RMS}$	RMS current	per terminal			200	A
$T_{VJ}$	virtual junction temperature		-40		125	°C
$T_{op}$	operation temperature		-40		100	°C
$T_{stg}$	storage temperature		-40		125	°C
<b>Weight</b>					90	g
$M_D$	mounting torque		2.5		4	Nm
$M_T$	terminal torque		2.5		4	Nm
$d_{Spp/App}$	creepage distance on surface   striking distance through air	terminal to terminal	13.0	9.7		mm
$d_{Spb/Apb}$		terminal to backside	16.0	16.0		mm
$V_{ISOL}$	isolation voltage	t = 1 second		3600		V
		t = 1 minute	50/60 Hz, RMS; $I_{ISOL} \leq 1$ mA	3000		V

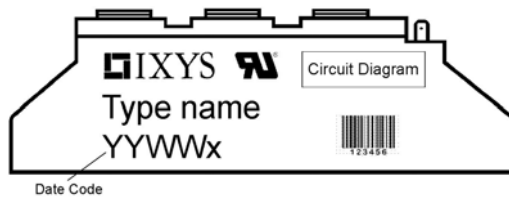

Ordering	Part Number	Marking on Product	Delivery Mode	Quantity	Code No.
Standard	MCC26-16io8B	MCC26-16io8B	Box	6	457825

Similar Part	Package	Voltage class
MCMA35P1600TA	TO-240AA-1B	1600
MCMA50P1600TA	TO-240AA-1B	1600

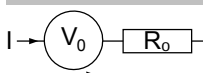
**Equivalent Circuits for Simulation**
*\* on die level*
 $T_{VJ} = 125\text{ °C}$ 

**Thyristor**

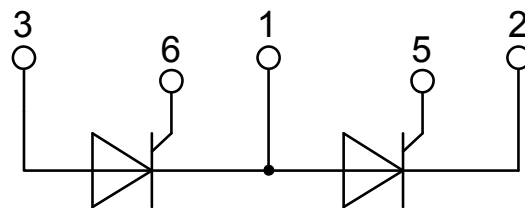
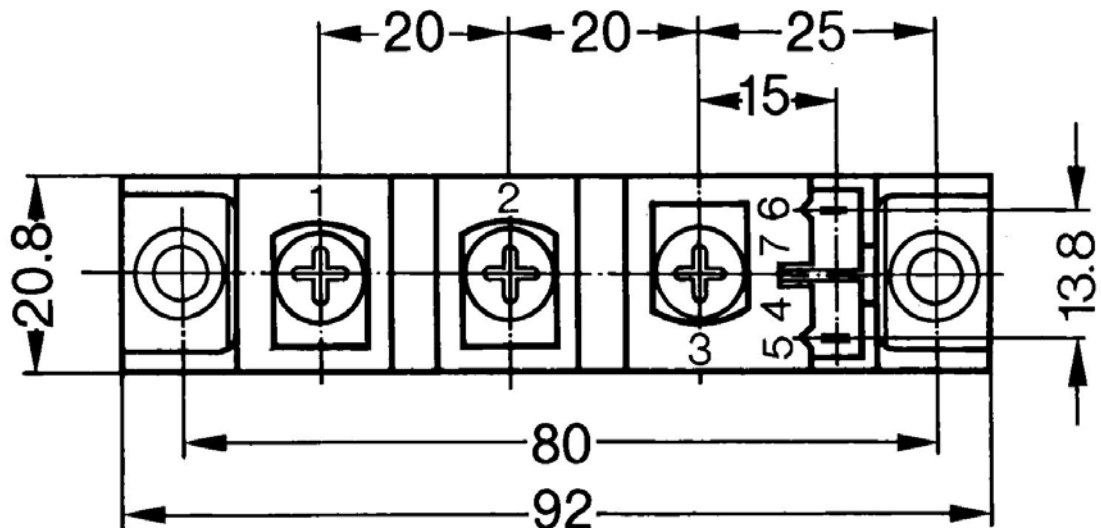
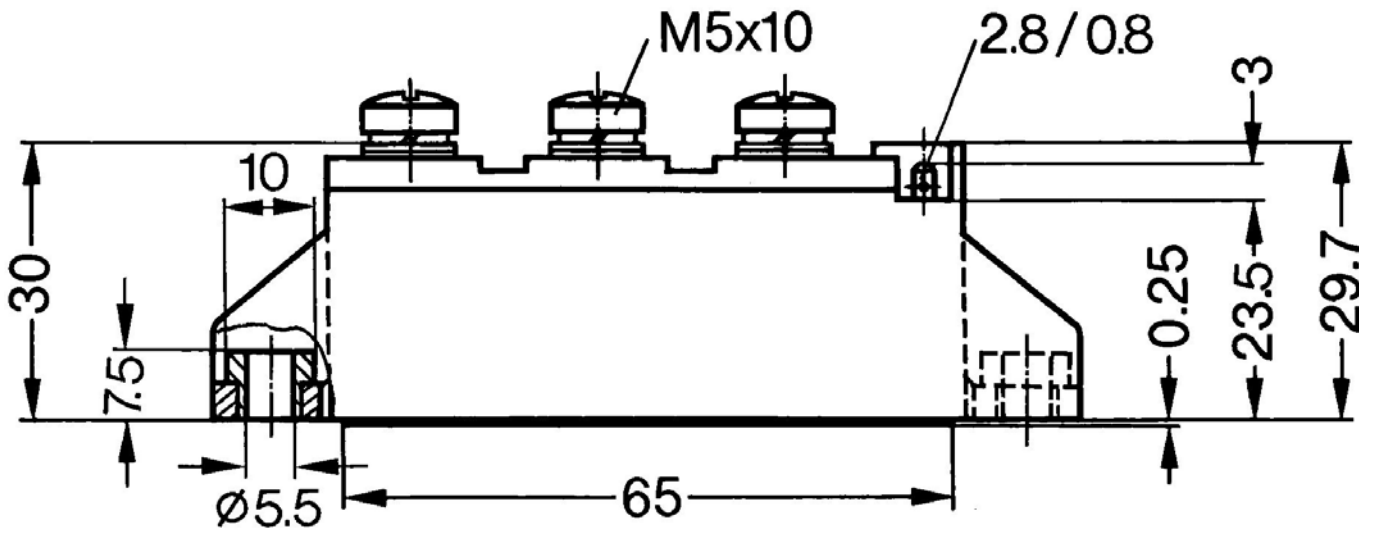
$V_{0\ max}$	threshold voltage	0.85	V
$R_{0\ max}$	slope resistance *	9.8	mΩ



## Thyristor

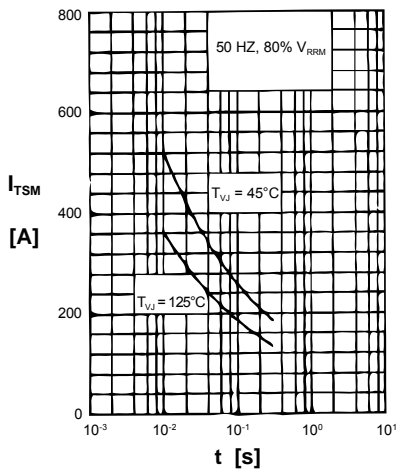

Fig. 1 Surge overload current  
 $I_{TSM}$ : Crest value,  $t$ : duration

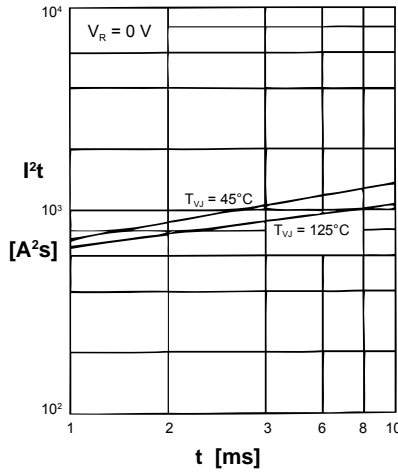

Fig. 2  $I^2t$  versus time (1-10 ms)

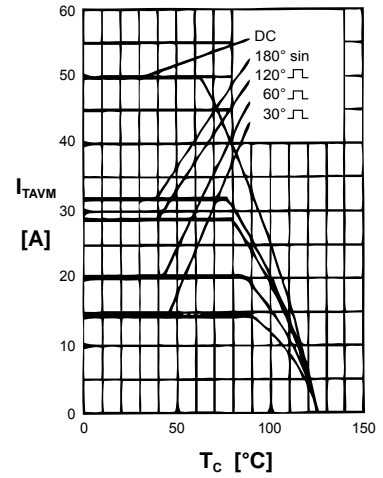

Fig. 3 Max. forward current at case temperature

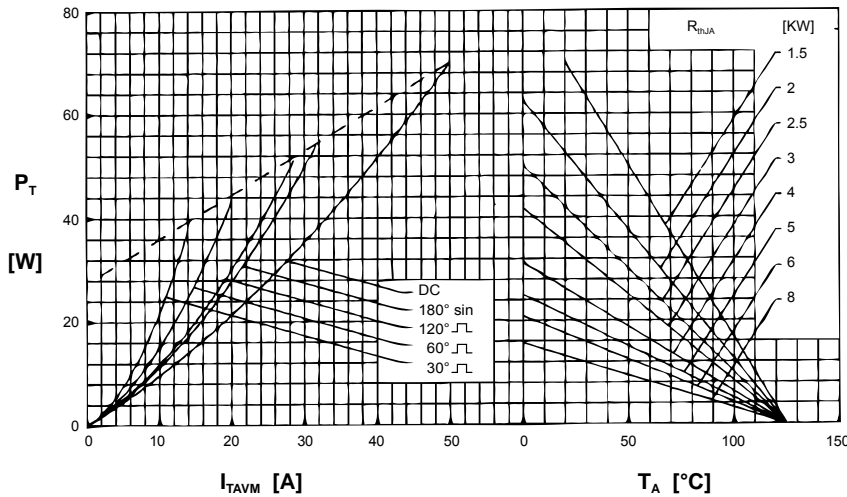

Fig. 4 Power dissipation versus onstate current & ambient temp. (per thyristor)

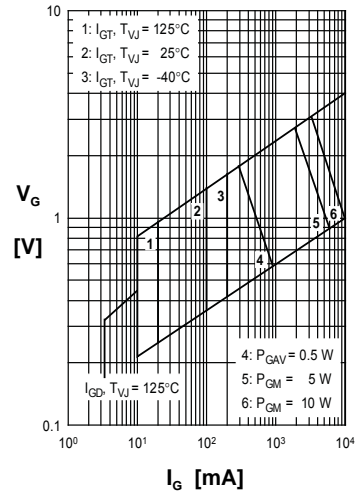

Fig. 5 Gate trigger charact.

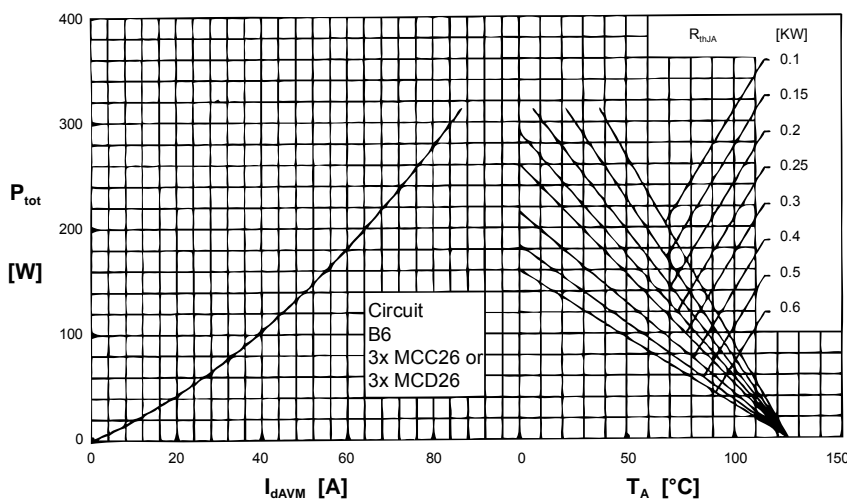

Fig. 6 Three phase rectifier bridge: Power dissipation versus direct output current and ambient temperature

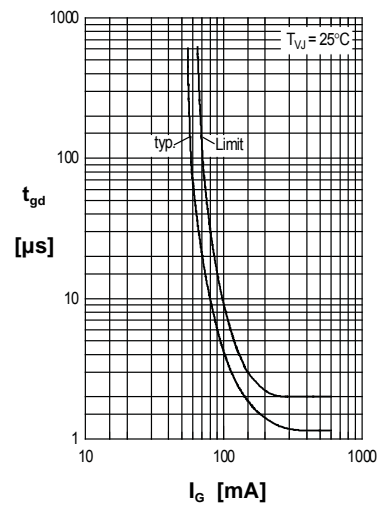

Fig. 7 Gate trigger delay time

**Thyristor**

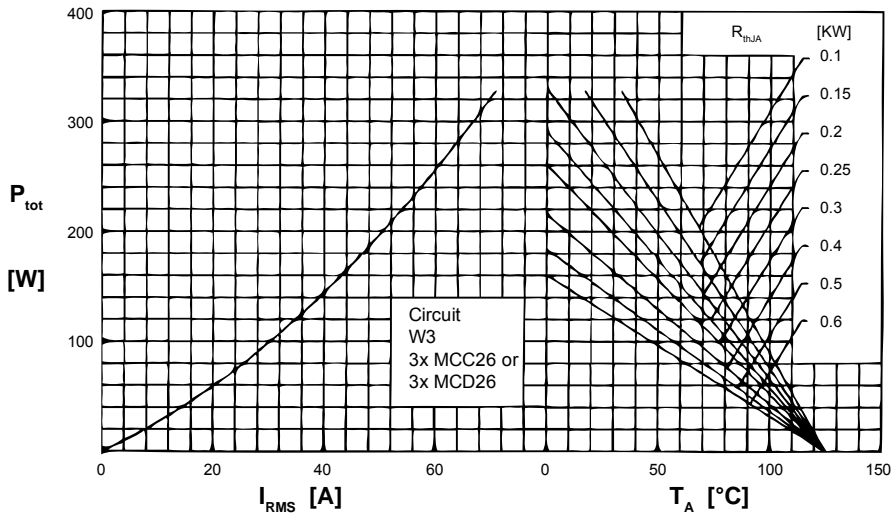

Fig. 8 Three phase AC-controller: Power dissipation vs. RMS output current and ambient temperature

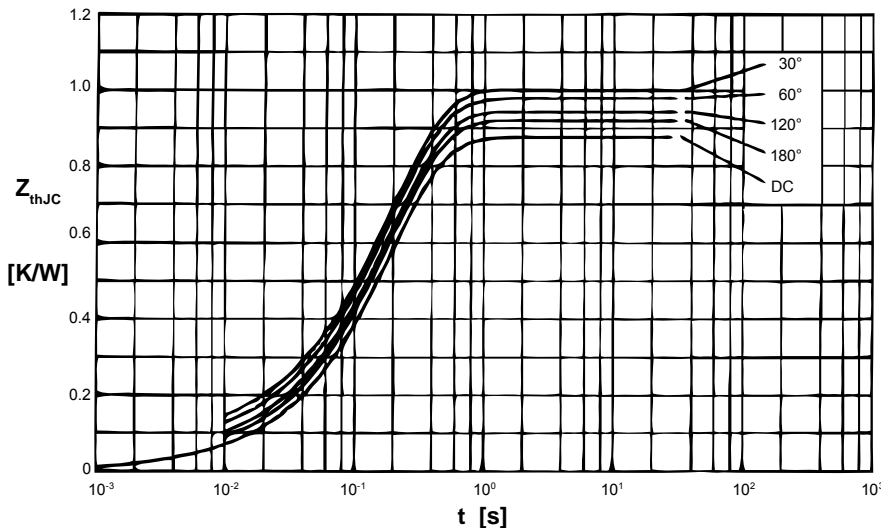

Fig. 9 Transient thermal impedance junction to case (per thyristor)

$R_{thJC}$  for various conduction angles  $d$ :

$d$	$R_{thJC}$ [K/W]
DC	0.88
180°	0.92
120°	0.95
60°	0.98
30°	1.01

Constants for  $Z_{thJC}$  calculation:

$i$	$R_{thi}$ [K/W]	$t_i$ [s]
1	0.019	0.0031
2	0.029	0.0216
3	0.832	0.1910

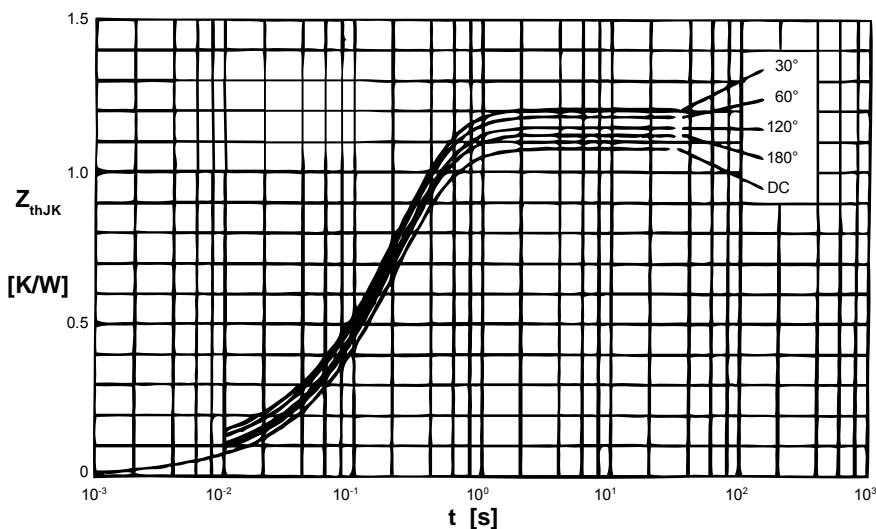

Fig. 10 Transient thermal impedance junction to heatsink (per thyristor)

$R_{thJK}$  for various conduction angles  $d$ :

$d$	$R_{thJK}$ [K/W]
DC	1.08
180°	1.12
120°	1.15
60°	1.18
30°	1.21

Constants for  $Z_{thJK}$  calculation:

$i$	$R_{thi}$ [K/W]	$t_i$ [s]
1	0.019	0.0031
2	0.029	0.0216
3	0.832	0.1910
4	0.200	0.4500