

Thyristor Module

$$V_{RRM} = 2 \times 1200V$$

$$I_{TAV} = 116A$$

$$V_T = 1.28V$$

Phase leg

Part number

MCC95-12io8B



Backside: isolated

 E72873

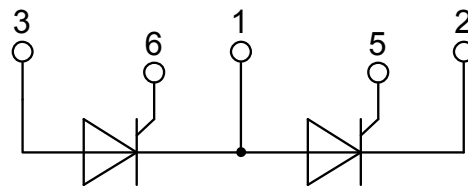

Features / Advantages:

- Thyristor for line frequency
- Planar passivated chip
- Long-term stability
- Direct Copper Bonded Al₂O₃-ceramic

Applications:

- Line rectifying 50/60 Hz
- Softstart AC motor control
- DC Motor control
- Power converter
- AC power control
- Lighting and temperature control

Package: TO-240AA

- Isolation Voltage: 3600 V~
- Industry standard outline
- RoHS compliant
- Soldering pins for PCB mounting
- Base plate: DCB ceramic
- Reduced weight
- Advanced power cycling

| Thyristor | | | | Ratings | | | |
|----------------|--|---|---------------------------|--|--|-------------------|-------------------|
| Symbol | Definition | Conditions | min. | typ. | max. | Unit | |
| $V_{RSM/DSM}$ | max. non-repetitive reverse/forward blocking voltage | $T_{VJ} = 25^{\circ}C$ | | | 1300 | V | |
| $V_{RRM/DRM}$ | max. repetitive reverse/forward blocking voltage | $T_{VJ} = 25^{\circ}C$ | | | 1200 | V | |
| I_{RD} | reverse current, drain current | $V_{R/D} = 1200 V$ | $T_{VJ} = 25^{\circ}C$ | | 200 | μA | |
| | | $V_{R/D} = 1200 V$ | $T_{VJ} = 125^{\circ}C$ | | 5 | mA | |
| V_T | forward voltage drop | $I_T = 150 A$ | $T_{VJ} = 25^{\circ}C$ | | 1.29 | V | |
| | | | | | 1.50 | V | |
| | | $I_T = 150 A$ | $T_{VJ} = 125^{\circ}C$ | | 1.28 | V | |
| | | | | | 1.70 | V | |
| I_{TAV} | average forward current | $T_C = 85^{\circ}C$ | $T_{VJ} = 125^{\circ}C$ | | 116 | A | |
| $I_{T(RMS)}$ | RMS forward current | 180° sine | | | 180 | A | |
| V_{T0} | threshold voltage | } for power loss calculation only | $T_{VJ} = 125^{\circ}C$ | | 0.85 | V | |
| r_T | slope resistance | | | | 2.4 | m Ω | |
| R_{thJC} | thermal resistance junction to case | | | | 0.22 | K/W | |
| R_{thCH} | thermal resistance case to heatsink | | | 0.20 | | K/W | |
| P_{tot} | total power dissipation | | $T_C = 25^{\circ}C$ | | 455 | W | |
| I_{TSM} | max. forward surge current | t = 10 ms; (50 Hz), sine | $T_{VJ} = 45^{\circ}C$ | | 2.25 | kA | |
| | | | | $V_R = 0 V$ | | 2.43 | kA |
| | | t = 8,3 ms; (60 Hz), sine | $T_{VJ} = 125^{\circ}C$ | | | 1.92 | kA |
| | | | | $V_R = 0 V$ | | 2.07 | kA |
| I^2t | value for fusing | t = 10 ms; (50 Hz), sine | $T_{VJ} = 45^{\circ}C$ | | 25.3 | kA ² s | |
| | | | | $V_R = 0 V$ | | 24.6 | kA ² s |
| | | t = 8,3 ms; (60 Hz), sine | $T_{VJ} = 125^{\circ}C$ | | | 18.3 | kA ² s |
| | | | | $V_R = 0 V$ | | 17.7 | kA ² s |
| C_J | junction capacitance | $V_R = 400 V$ f = 1 MHz | $T_{VJ} = 25^{\circ}C$ | | 119 | pF | |
| P_{GM} | max. gate power dissipation | $t_p = 30 \mu s$ | $T_C = 125^{\circ}C$ | | 10 | W | |
| | | $t_p = 300 \mu s$ | | | 5 | W | |
| P_{GAV} | average gate power dissipation | | | | 0.5 | W | |
| $(di/dt)_{cr}$ | critical rate of rise of current | $T_{VJ} = 125^{\circ}C$; f = 50 Hz | repetitive, $I_T = 250 A$ | | 150 | A/ μs | |
| | | | | $t_p = 200 \mu s$; $di_G/dt = 0.45 A/\mu s$; | | | |
| $(dv/dt)_{cr}$ | critical rate of rise of voltage | $V_D = \frac{2}{3} V_{DRM}$ | $T_{VJ} = 125^{\circ}C$ | non-repet., $I_T = 116 A$ | 500 | A/ μs | |
| | | | | | $R_{GK} = \infty$; method 1 (linear voltage rise) | | 1000 |
| V_{GT} | gate trigger voltage | $V_D = 6 V$ | $T_{VJ} = 25^{\circ}C$ | | 2.5 | V | |
| | | | $T_{VJ} = -40^{\circ}C$ | | 2.6 | V | |
| I_{GT} | gate trigger current | $V_D = 6 V$ | $T_{VJ} = 25^{\circ}C$ | | 150 | mA | |
| | | | $T_{VJ} = -40^{\circ}C$ | | 200 | mA | |
| V_{GD} | gate non-trigger voltage | $V_D = \frac{2}{3} V_{DRM}$ | $T_{VJ} = 125^{\circ}C$ | | 0.2 | V | |
| I_{GD} | gate non-trigger current | | | | 10 | mA | |
| I_L | latching current | $t_p = 10 \mu s$ | $T_{VJ} = 25^{\circ}C$ | | 450 | mA | |
| | | | | $I_G = 0.45 A$; $di_G/dt = 0.45 A/\mu s$ | | | |
| I_H | holding current | $V_D = 6 V$ $R_{GK} = \infty$ | $T_{VJ} = 25^{\circ}C$ | | 200 | mA | |
| t_{gd} | gate controlled delay time | $V_D = \frac{1}{2} V_{DRM}$ | $T_{VJ} = 25^{\circ}C$ | | 2 | μs | |
| | | | | $I_G = 0.45 A$; $di_G/dt = 0.45 A/\mu s$ | | | |
| t_q | turn-off time | $V_R = 100 V$; $I_T = 150 A$; $V_D = \frac{2}{3} V_{DRM}$ | $T_{VJ} = 125^{\circ}C$ | | 185 | μs | |
| | | $di/dt = 10 A/\mu s$; $dv/dt = 20 V/\mu s$; $t_p = 200 \mu s$ | | | | | |

| Package TO-240AA | | | | Ratings | | |
|------------------|--|----------------------|-------------------------------------|---------|------|------|
| Symbol | Definition | Conditions | min. | typ. | max. | Unit |
| I_{RMS} | RMS current | per terminal | | | 200 | A |
| T_{VJ} | virtual junction temperature | | -40 | | 125 | °C |
| T_{op} | operation temperature | | -40 | | 100 | °C |
| T_{stg} | storage temperature | | -40 | | 125 | °C |
| Weight | | | | | 90 | g |
| M_D | mounting torque | | 2.5 | | 4 | Nm |
| M_T | terminal torque | | 2.5 | | 4 | Nm |
| $d_{Spp/App}$ | creepage distance on surface striking distance through air | terminal to terminal | 13.0 | 9.7 | | mm |
| $d_{Spb/Apb}$ | | terminal to backside | 16.0 | 16.0 | | mm |
| V_{ISOL} | isolation voltage | t = 1 second | | 3600 | | V |
| | | t = 1 minute | 50/60 Hz, RMS; $I_{ISOL} \leq 1$ mA | 3000 | | V |

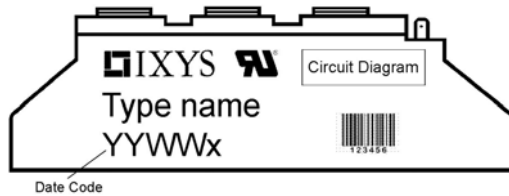

| Ordering | Part Number | Marking on Product | Delivery Mode | Quantity | Code No. |
|----------|--------------|--------------------|---------------|----------|----------|
| Standard | MCC95-12io8B | MCC95-12io8B | Box | 6 | 457892 |

| Similar Part | Package | Voltage class |
|----------------|-------------|---------------|
| MCMA110P1200TA | TO-240AA-1B | 1200 |
| MCMA140P1200TA | TO-240AA-1B | 1200 |

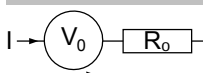
Equivalent Circuits for Simulation
** on die level*
 $T_{VJ} = 125\text{ °C}$

Thyristor

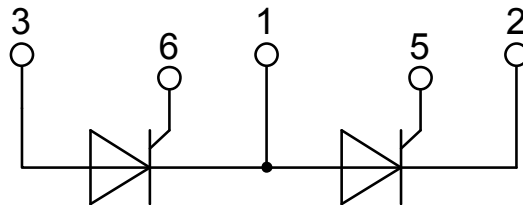
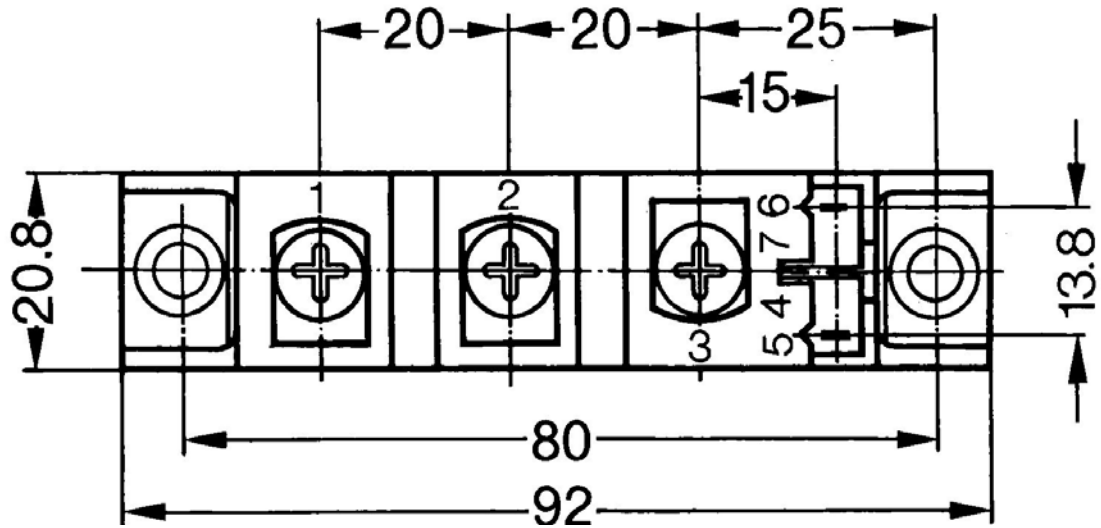
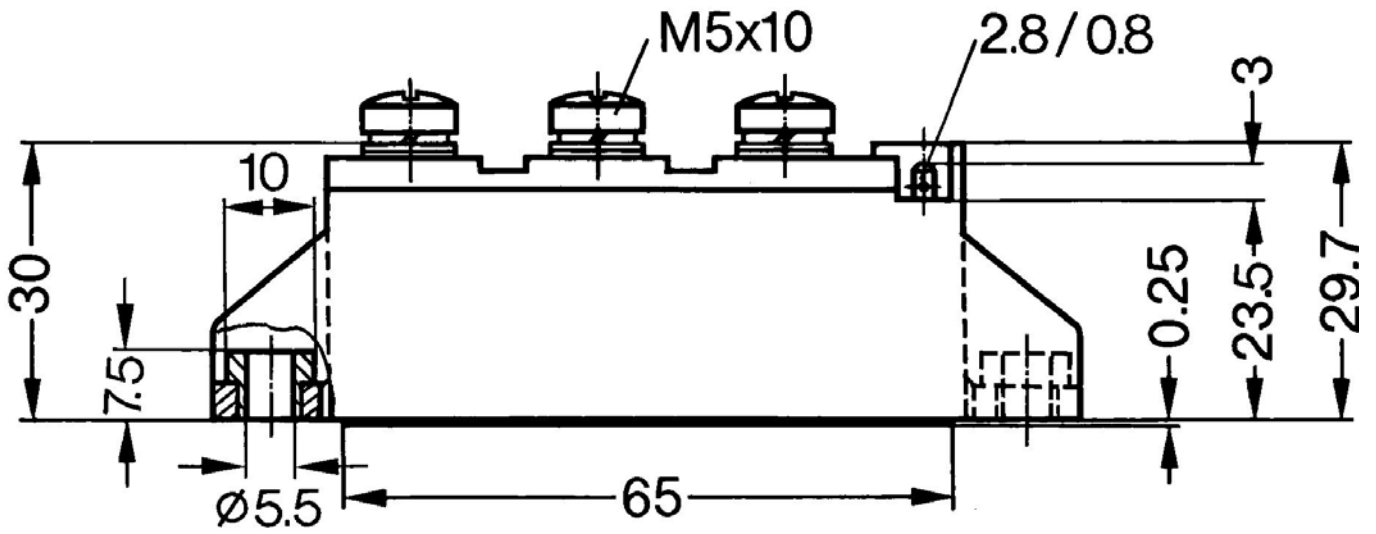
| | | | |
|--------------|--------------------|------|----|
| $V_{0\ max}$ | threshold voltage | 0.85 | V |
| $R_{0\ max}$ | slope resistance * | 1.2 | mΩ |



Thyristor

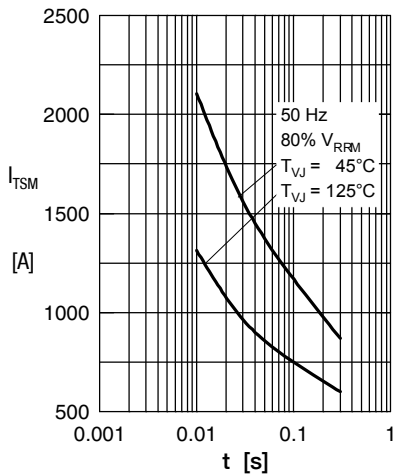

Fig. 1 Surge overload current I_{TSM} , I_{FSM} : Crest value, t : duration

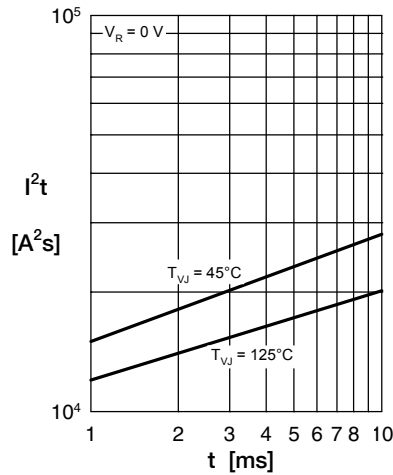

Fig. 2 I^2t versus time (1-10 ms)

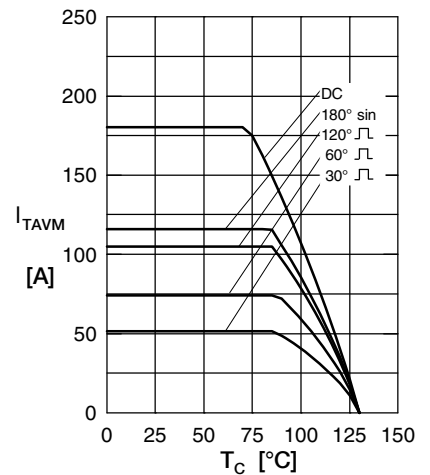

Fig. 3 Max. forward current at case temperature

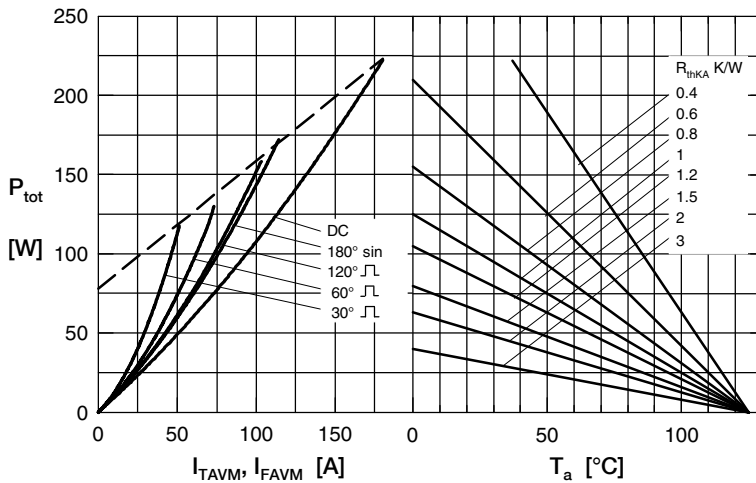

Fig. 4 Power dissipation vs. on-state current & ambient temperature (per thyristor or diode)

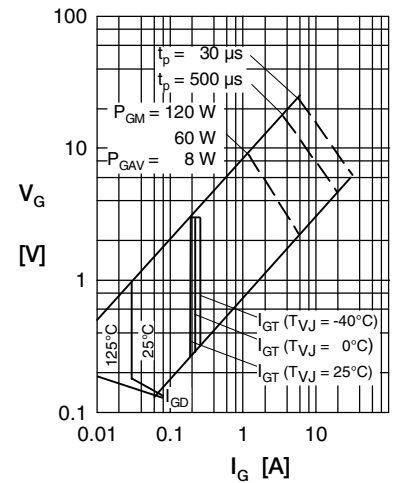

Fig. 5 Gate trigger characteristics

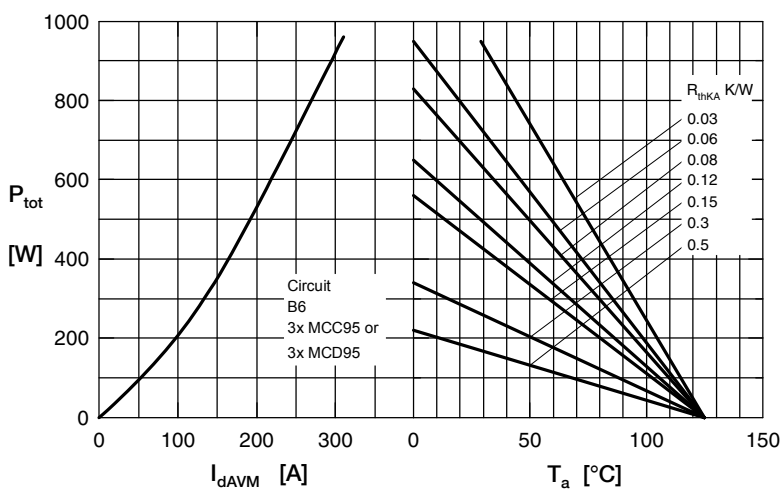

Fig. 6 Three phase rectifier bridge: Power dissipation vs. direct output current and ambient temperature

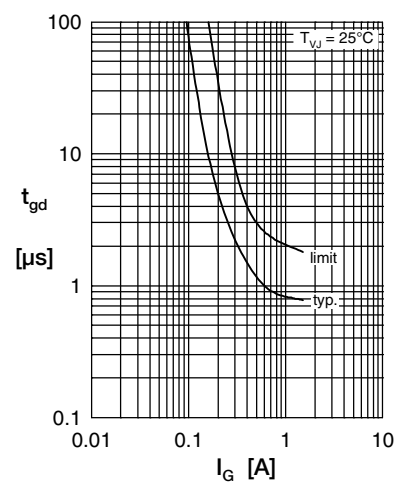

Fig. 7 Gate trigger delay time

Thyristor

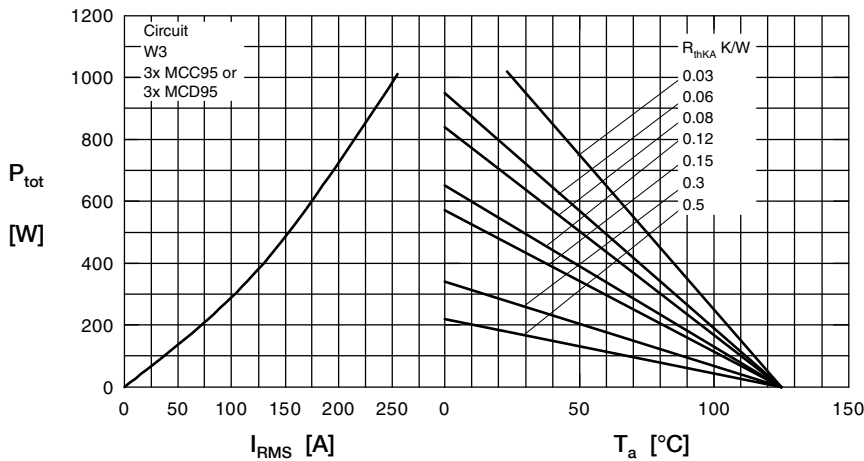
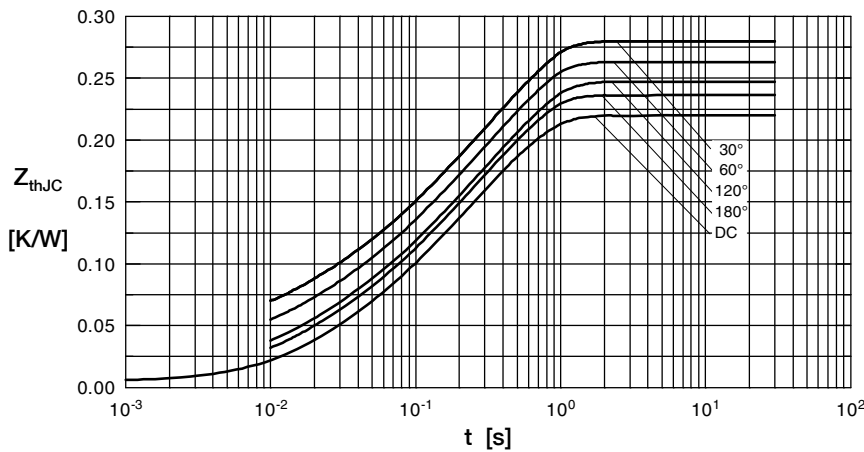

Fig. 8 Three phase AC-controller: Power dissipation versus RMS output current and ambient temperature



R_{thJC} for various conduction angles d:

| d | R_{thJC} [K/W] |
|------|------------------|
| DC | 0.22 |
| 180° | 0.23 |
| 120° | 0.25 |
| 60° | 0.27 |
| 30° | 0.28 |

Constants for Z_{thJC} calculation:

| i | R_{thi} [K/W] | t_i [s] |
|---|-----------------|-----------|
| 1 | 0.0066 | 0.0019 |
| 2 | 0.0678 | 0.0477 |
| 3 | 0.1456 | 0.3440 |

Fig. 9 Transient thermal impedance junction to case (per thyristor/diode)

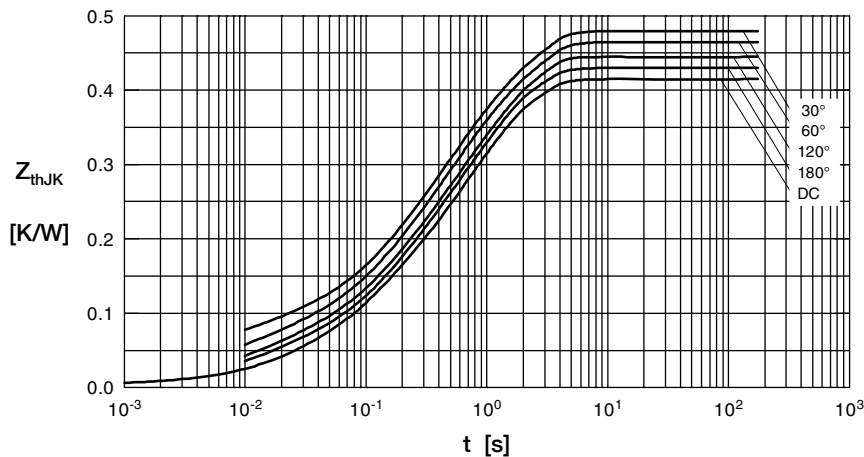

R_{thJK} for various conduction angles d:

| d | R_{thJK} [K/W] |
|------|------------------|
| DC | 0.42 |
| 180° | 0.43 |
| 120° | 0.45 |
| 60° | 0.47 |
| 30° | 0.48 |

Constants for Z_{thJK} calculation:

| i | R_{thi} [K/W] | t_i [s] |
|---|-----------------|-----------|
| 1 | 0.0066 | 0.0019 |
| 2 | 0.0678 | 0.0477 |
| 3 | 0.1456 | 0.3440 |
| 4 | 0.2000 | 1.3200 |

Fig. 10 Transient thermal impedance junction to heatsink (per thyristor/diode)