

# Fast Turn-off Thyristor Stud Types P0248SX10# to P0248SX12#

The data sheet on the subsequent pages of this document is a scanned copy of existing data for this product.  
(Rating Report 83TR8 Issue 2)

This data reflects the old part number for this product which is: P200PH02-12.  
This part number must **NOT** be used for ordering purposes – please use the ordering particulars detailed below.

The limitations of this data are as follows:  
Device only available for grades 10 and 12 (1000V & 1200V  $V_{RRM}/V_{DRM}$ )  
Only SC outline drawing (W18) in datasheet

The following links will direct you to the appropriate outline drawings  
[Outline W18](#) – 3/4" Ceramic stud  
[Outline W25](#) – 3/4" Ceramic stud removed

Where any information on the product matrix page differs from that in the following data, the product matrix must be considered correct

An electronic data sheet for this product is presently in preparation.

For further information on this product, please contact your local ASM or distributor.

Alternatively, please contact Westcode as detailed below.

<b>Ordering Particulars</b>			
P0248	SX	◆◆	0
Fixed Type Code	SC - 3/4" Ceramic stud SD – 3/4" Ceramic stud removed	Voltage code $V_{RRM}/100$ 10-12	Fixed Turn-off Time Code D = 20µs, E = 25µs, F = 30µs
Typical Order Code: P0248SC12D, 3/4" Ceramic stud, 1200V $V_{RRM}/V_{DRM}$ , 20µs $t_q$			

<p><b>IXYS Semiconductor GmbH</b> Edisonstraße 15 D-68623 Lampertheim Tel: +49 6206 503-0 Fax: +49 6206 503-627 E-mail: <a href="mailto:marcom@ixys.de">marcom@ixys.de</a></p>	<p style="font-size: 1.2em; margin: 0;">An  IXYS Company</p> <p style="margin: 10px 0 0 0;"><a href="http://www.westcode.com">www.westcode.com</a></p> <p style="margin: 0 0 0 0;"><a href="http://www.ixys.com">www.ixys.com</a></p>	<p><b>Westcode Semiconductors Ltd</b> Langley Park Way, Langley Park, Chippenham, Wiltshire, SN15 1GE. Tel: +44 (0)1249 444524 Fax: +44 (0)1249 659448 E-mail: <a href="mailto:WSL.sales@westcode.com">WSL.sales@westcode.com</a></p> <p><b>Westcode Semiconductors Inc</b> 3270 Cherry Avenue Long Beach CA 90807 USA Tel: +1 (562) 595 6971 Fax: +1 (562) 595 8182 E-mail: <a href="mailto:WSI.sales@westcode.com">WSI.sales@westcode.com</a></p>
<p>The information contained herein is confidential and is protected by Copyright. The information may not be used or disclosed except with the written permission of and in the manner permitted by the proprietors Westcode Semiconductors Ltd. <span style="float: right;">© Westcode Semiconductors Ltd.</span></p> <p>In the interest of product improvement, Westcode reserves the right to change specifications at any time without prior notice.</p> <p>Devices with a suffix code (2-letter, 3-letter or letter/digit/letter combination) added to their generic code are not necessarily subject to the conditions and limits contained in this report.</p>		

QUALITY EVALUATION LABORATORY

Rating Report: 83TR8 (Issue 2)

Date: 29th January, 1985

Origin:

Pages: 24

Thyristor type P200PH02-H12

Written: B.W.P. Brown

Checked: *BWPB*

Approved: *BRS4*

---

The P200PH02-H12 series of thyristors are centre regenerative gate diffused devices mounted under spring pressure in a stud base, top hat housing with flexible lead. A 24mm diameter slice is employed.

Ratings and Characteristics

Ratings

Voltage Grades	: H02-H12
$V_{DSM}$	: 200-1200V
$V_{RSM}$	: 300-1300V
$V_{DRM}, V_{RRM}$	: 200-1200V
$I_T(AV)$ : Single phase: 50Hz, 180° sinewave T <sub>CASE</sub> = 85°C	: 160A
$I_T(rms)$ max.	: 355A
$I_T$ d.c. max.	: 355A
$I_{TSM}$ : t = 10ms half sinewave; T <sub>J</sub> (initial) = 125°C: V <sub>RM</sub> = 0.6V <sub>RRM</sub> (MAX)	: 2700A
$I_{TSM}$ : t = 10ms half sinewave; T <sub>J</sub> (initial) = 125°C: V <sub>RM</sub> ≤ 10V	: 2970A
$I^2t$ : t = 10ms; T <sub>J</sub> (initial) = 125°C : V <sub>RM</sub> = 0.6V <sub>RRM</sub> (MAX)	: 36.5 × 10 <sup>3</sup> A <sup>2</sup> SECS
$I^2t$ : t = 10ms; T <sub>J</sub> (initial) = 125°C : V <sub>RM</sub> ≤ 10V	: 44.1 × 10 <sup>3</sup> A <sup>2</sup> SECS
$I^2t$ : t = 3ms; T <sub>J</sub> (initial) = 125°C : V <sub>RM</sub> ≤ 10V	: 32.4 × 10 <sup>3</sup> A <sup>2</sup> SECS
di/dt: (Repetitive) T <sub>J</sub> 125°C. Gate: 20V. 20 Ω Rise-time 1μS	: 500A/μS
IFGM : Anode positive with respect to cathode	: 18A
VFGM : " " " " "	: 12V
VRGM :	: 5V
PG(AV) :	: 1.5W
PGM :	: 60W
VGD :	: 0.25V
THS operating range	: -40 to 125°C
T <sub>stg</sub> Non-operating	: -40 to 180°C



CONTENTS

	<u>Page</u>
Provisional ratings and characteristics	1, 2
Contents	3
Voltage grade table	4
Extension of voltage grades	4
2. <u>Introduction</u>	5
3. <u>Notes on the ratings</u>	
a) Rate of rise of on-state current	5
b) Square-wave ratings	5
c) Duty cycle lines	5
d) Maximum operating frequency	5
e) Energy per pulse characteristics	5
4. <u>Reverse Recovery Loss</u>	
a) Determination by Measurement	6
b) Determination without Measurement	6
5. <u>Gate Drive</u>	7
6. <u>The DV/DT Suppression Network</u>	7
7. <u>Note 1</u> Reverse recovery loss by Measurement	7
<u>Note 2</u> Housing Losses	7
Limit on-state characteristic	8
Gate characteristics	9,10
Transient Thermal Impedance	11
Surge Rating	12
Recovered Charge	13
Reverse Recovery Energy per Pulse	14
Square Wave Frequency Rating 90°C Case; 500A/uS	15
Square Wave Frequency Rating 65°C " "	16
Square Wave Frequency Rating 90°C Case, 100A/uS	17
Square Wave Frequency Rating 65°C " "	18
Energy per Pulse 500A/uS	19
Energy per Pulse 100A/uS	20
Sine wave Frequency Rating 90°C Case	21
Sine wave Frequency Rating 65°C "	22
Sine wave Energy per Pulse	23
Outline Drawing	24

Voltage Ratings

Voltage Grade 'H'	VDSM VDRM VRRM V	VRSM V	VD VR DC
02	200	300	140
03	300	400	210
04	400	500	260
06	600	700	420
08	800	900	560
10	1000	1100	700
12	1200	1300	810

Extension of Voltage Grades

This report is applicable to other and higher voltage grades when supply has been agreed by Sales/Production.

## 2. INTRODUCTION

The P200PH02-12 thyristor series are diffused centre regenerative gate devices employing a 24 mm diameter slice mounted on a stud base with top hat housing and flexible lead.

## 3. NOTES ON THE RATINGS

### a) Rate of rise of on-state current

The maximum un-primed rate of rise of on-state current must not exceed 1000A/uS at any time during turn-on on a non-repetitive basis. For repetitive performance the on-state rate of rise of current must not exceed 500A/uS at any time during turn-on. Note that these values of current rate of rise apply to the circuit external to the device and its specified snubber network and device current rates of rise will be higher.

### b) Square wave ratings

These ratings are given for leading edge linear rates of rise of forward current of 100 and 500A/uS.

### c) Duty Cycle Lines

The 100% duty cycle line appears on all these ratings. These frequency ratings are presented in the form that all duty cycles may be represented by straight parallel lines.

### d) Maximum operating frequency

The maximum operating frequency is set by the time required for the thyristor to turn off ( $t_q$ ) and for the off-state voltage to reach full value ( $t_v$ ), i.e.

$$f_{\text{max.}} = \frac{1}{t_{\text{pulse}} + t_q + t_v}$$

### e) Energy per pulse characteristics

These curves enable rapid estimation of device dissipation to be obtained for conditions not covered by the frequency ratings.

Let  $E_p$  be the Energy per pulse for a given current and pulse width, in joules

Let  $R_{th}$  be the steady-state thermal resistance (junction to case) and  $T_{CASE}$  be the case temperature

Then the average dissipation will be

$$W_{AV} = E_p \times f$$

and

$$T_{CASE} = 125 - W_{AV} \times R_{th}$$

#### 4. REVERSE RECOVERY LOSS

On account of the number of circuit variables affecting reverse recovery voltage, no allowance for reverse recovery loss has been made in these ratings. The following procedure is recommended for use where it is necessary to include reverse recovery loss.

##### a) Determination by Measurement

From waveforms of recovery current obtained from a high frequency shunt (see Note 1) and reverse voltage present during recovery, an instantaneous reverse recovery loss waveform must be constructed. Let the area under this waveform be A joules per pulse. A new case temperature can then be evaluated from:

$$T_{\text{CASE (new)}} = T_{\text{CASE (original)}} - A \left( \frac{r_t \cdot 10^6}{t} + R_{\text{th}} \times f \right)$$

$$\text{where } r_t = 1.64 \times 10^{-4} \sqrt{t}$$

t - duration of reverse recovery loss per pulse in microseconds

A = Area under reverse loss waveform per pulse in joules (.W.S.)

f = rated frequency at the original case temperature

The total dissipation is now given by

$$W_{\text{(TOT)}} = W_{\text{(original)}} + A \times f$$

##### b) Determination without Measurement

In circumstances where it is not possible to measure voltage and current conditions, or for design purposes, the additional losses may be estimated from curves on page 14. A typical R-C snubber network is connected across the thyristor to control the transient reverse voltage waveform.

Let E be the value of energy per reverse cycle in joules (curves on p. 14)

Let f be the operating frequency in Hz

$$\text{then } T_{\text{CASE new}} = T_{\text{CASE original}} - (E \times R_{\text{th}} \times f)$$

where  $T_{\text{CASE new}}$  is the required maximum case temperature and  $T_{\text{CASE original}}$  is the case temperature given with the frequency ratings.

5. GATE DRIVE

The recommended gate drive is 20V, 20ohms with a short-circuit current rise time of not more than 1uS. This gate drive must be applied when using the full di/dt capability of the device.

6. THE DV/DI SUPPRESSION NETWORK

The effect of a conventional resistor-capacitor snubber of 0.22uf, 22 ohms has been included in these ratings and all rating di/dt values apply to the circuit external to the thyristor and its suppression network.

7. NOTE 1

REVERSE RECOVERY LOSS BY MEASUREMENT

This thyristor has a low reverse recovered charge and peak reverse recovery current. When measuring the charge care must be taken to ensure that:

- a) a.c. coupled devices such as current transformers are not affected by prior passage of high amplitude forward current.
- b) The measuring oscilloscope has adequate dynamic range - typically 100 screen heights - to cope with the initial forward current without overload.

NOTE 2

HOUSING LOSS

The loss caused by coupling between housing and anode current (which gives rise to additional heating at high frequency) has been incorporated into the curves of forward energy loss per pulse.



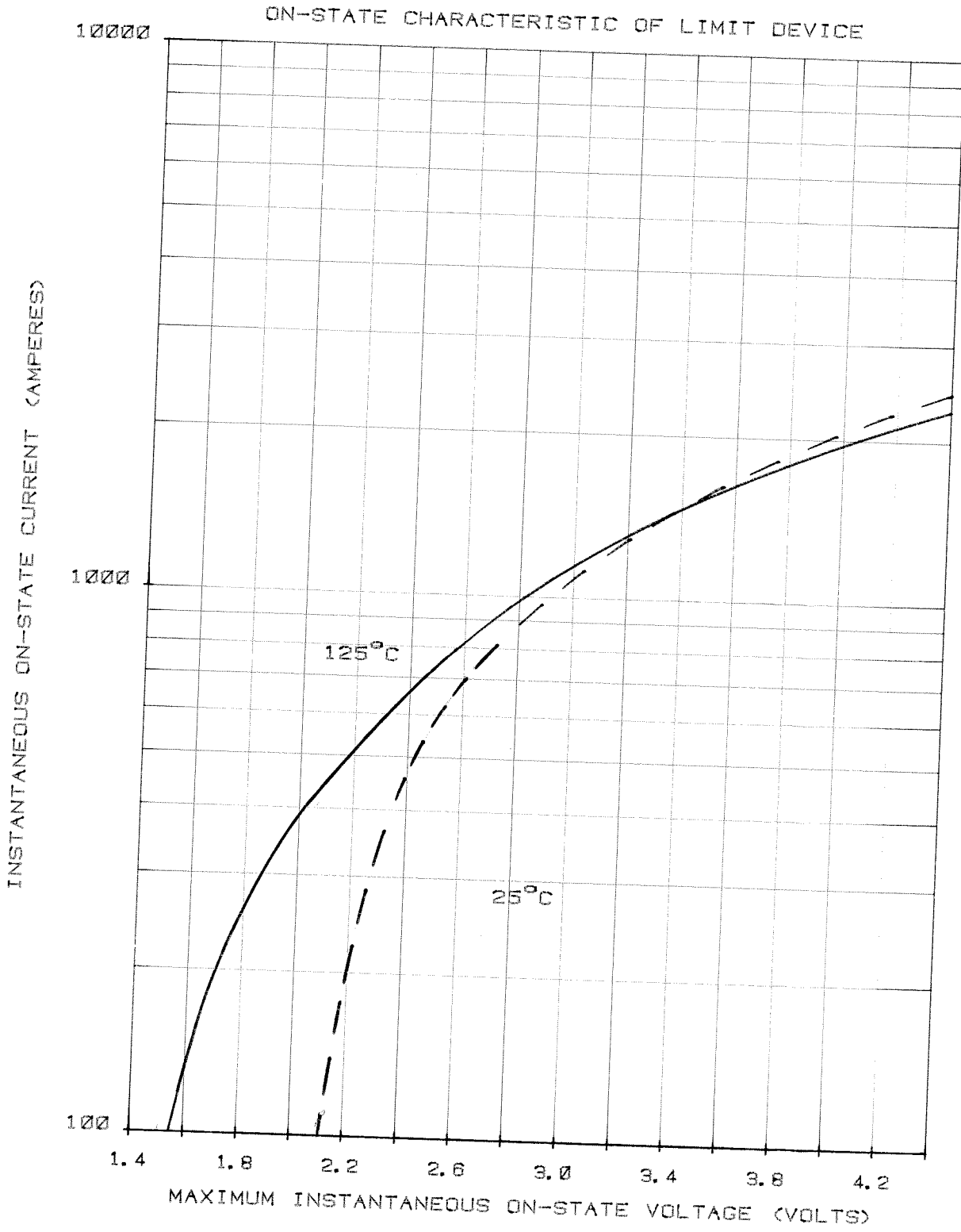

### GATE TRIGGERING CHARACTERISTICS

(TRIGGER POINTS OF ALL THYRISTORS LIE IN THE AREAS SHOWN)

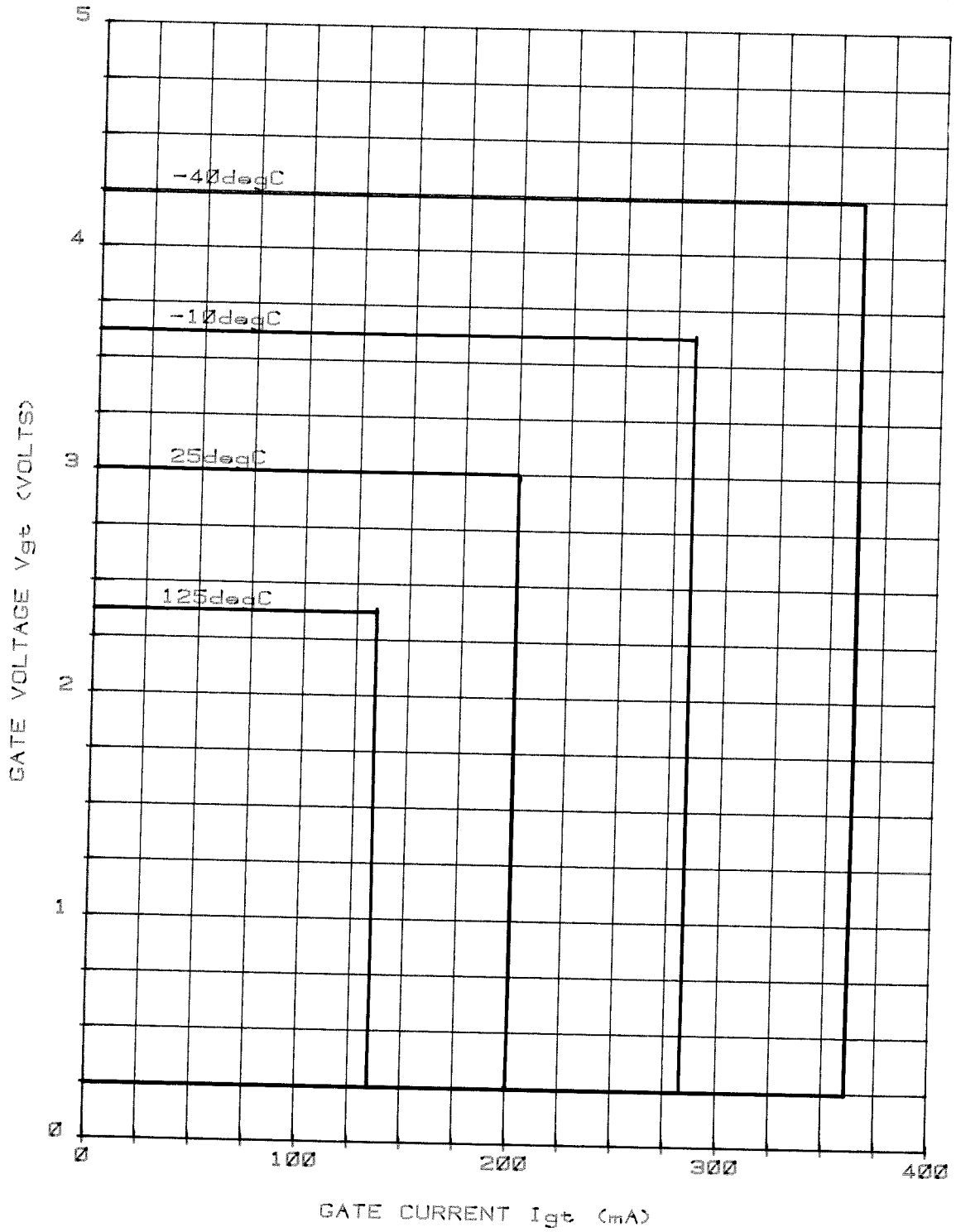

P2000  
T'S 14

GATE CHARACTERISTICS AT 25°C JUNCTION TEMPERATURE

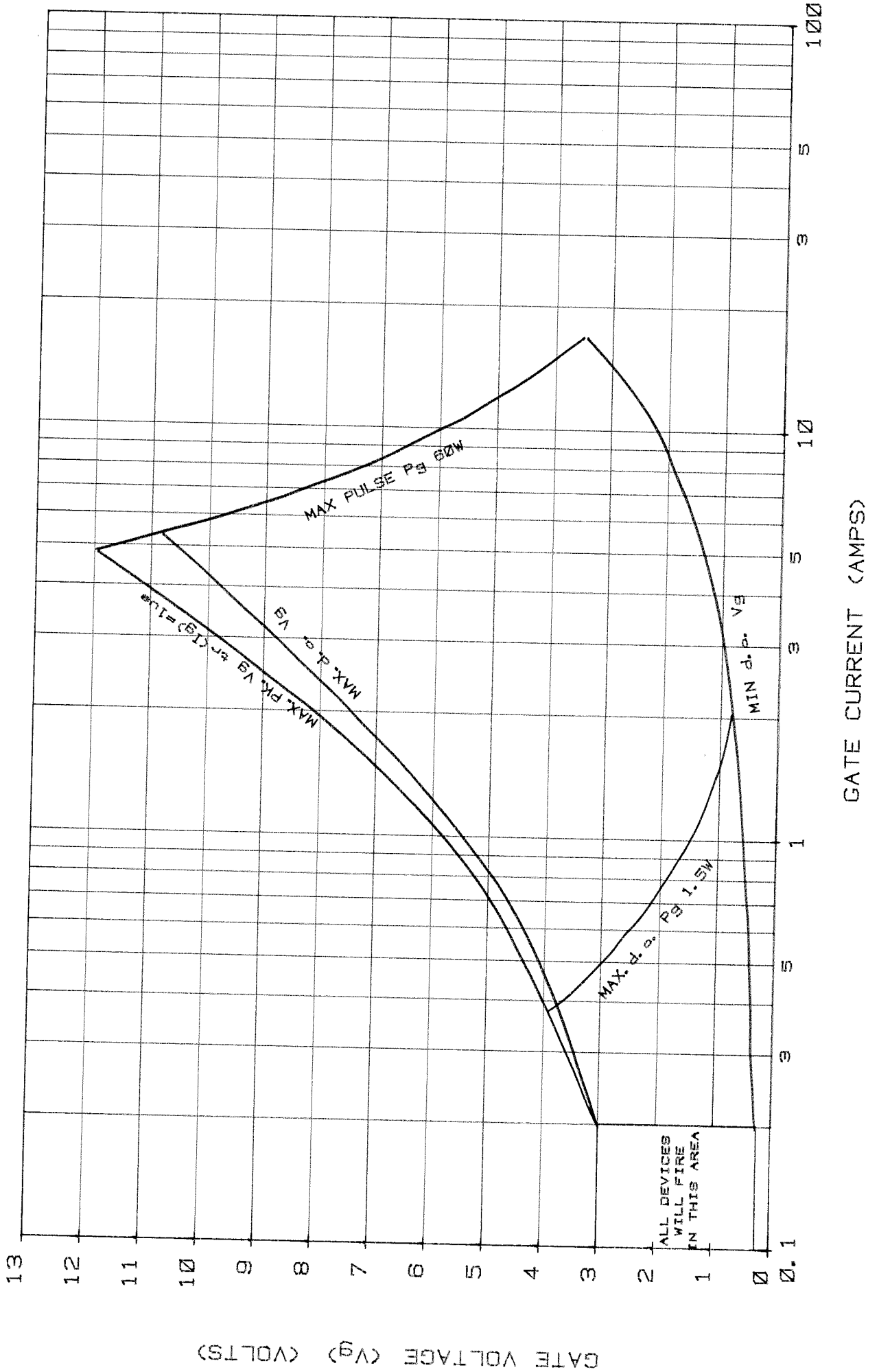

W-02  
Fig. 12

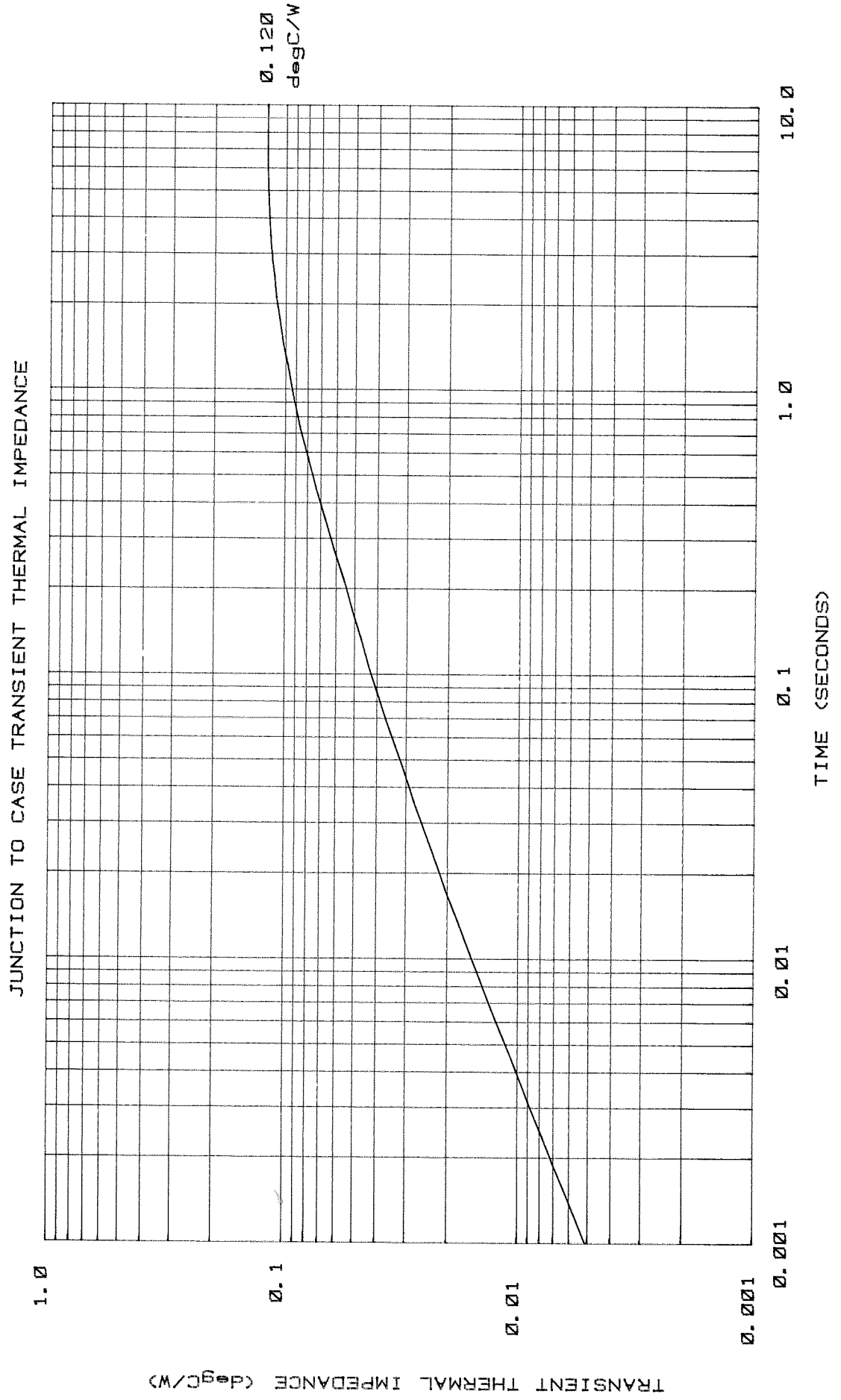

MAXIMUM NON REPETITIVE SURGE CURRENT AT INITIAL JUNCTION TEMPERATURE 125°C

GATE MAY TEMPORARILY LOSE CONTROL OF CONDUCTION ANGLE

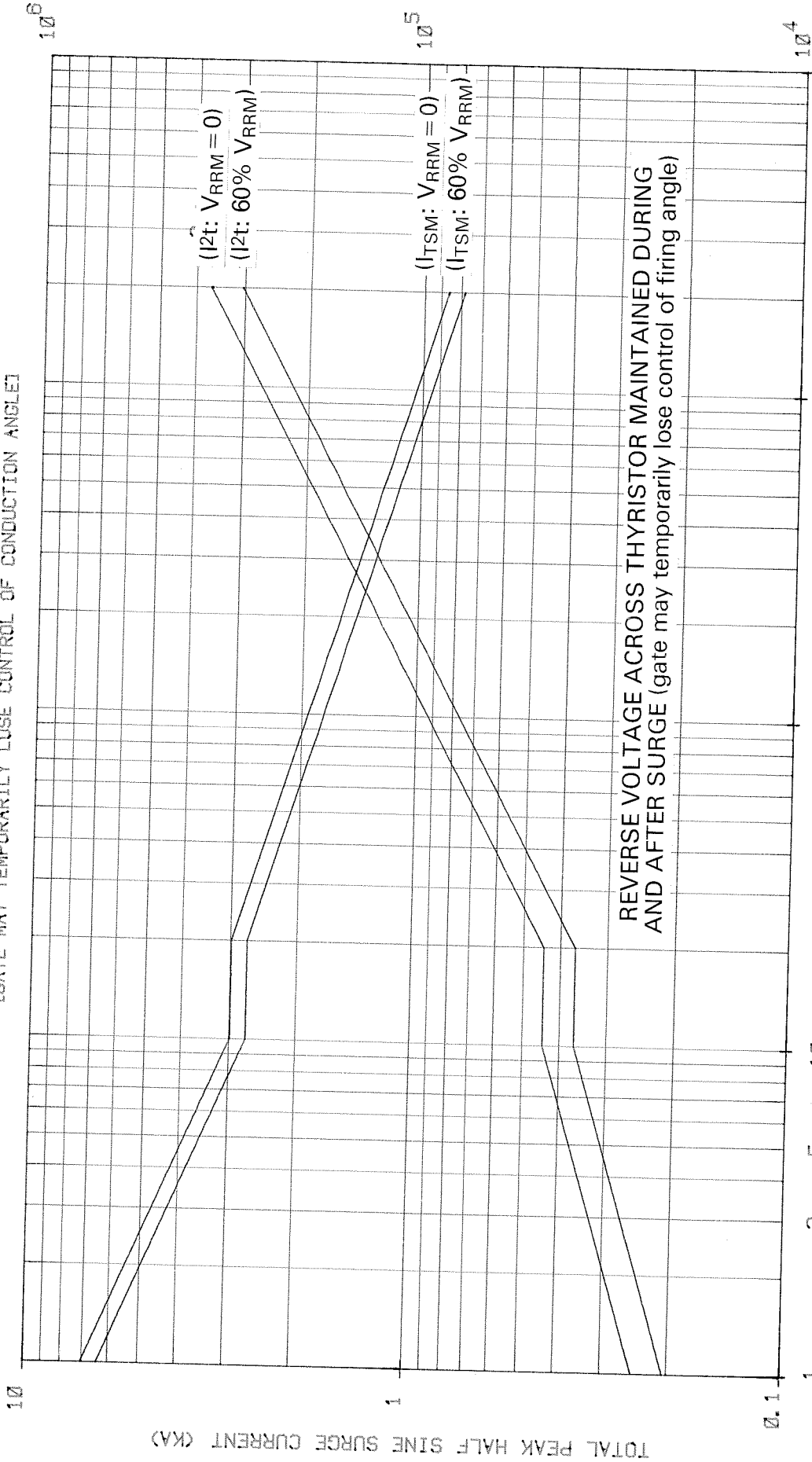

REVERSE VOLTAGE ACROSS THYRISTOR MAINTAINED DURING AND AFTER SURGE (gate may temporarily lose control of firing angle)

Figure 13

DURATION OF SURGE (cycles at 50 Hz)

DURATION OF SURGE (ms)

MAXIMUM  $I^2t$  (AMPS<sup>2</sup> SECS)

TOTAL PEAK HALF SINE SURGE CURRENT (KA)

2200P  
Fig 13

TYPICAL RECOVERED CHARGE AT 125°C JUNCTION TEMPERATURE

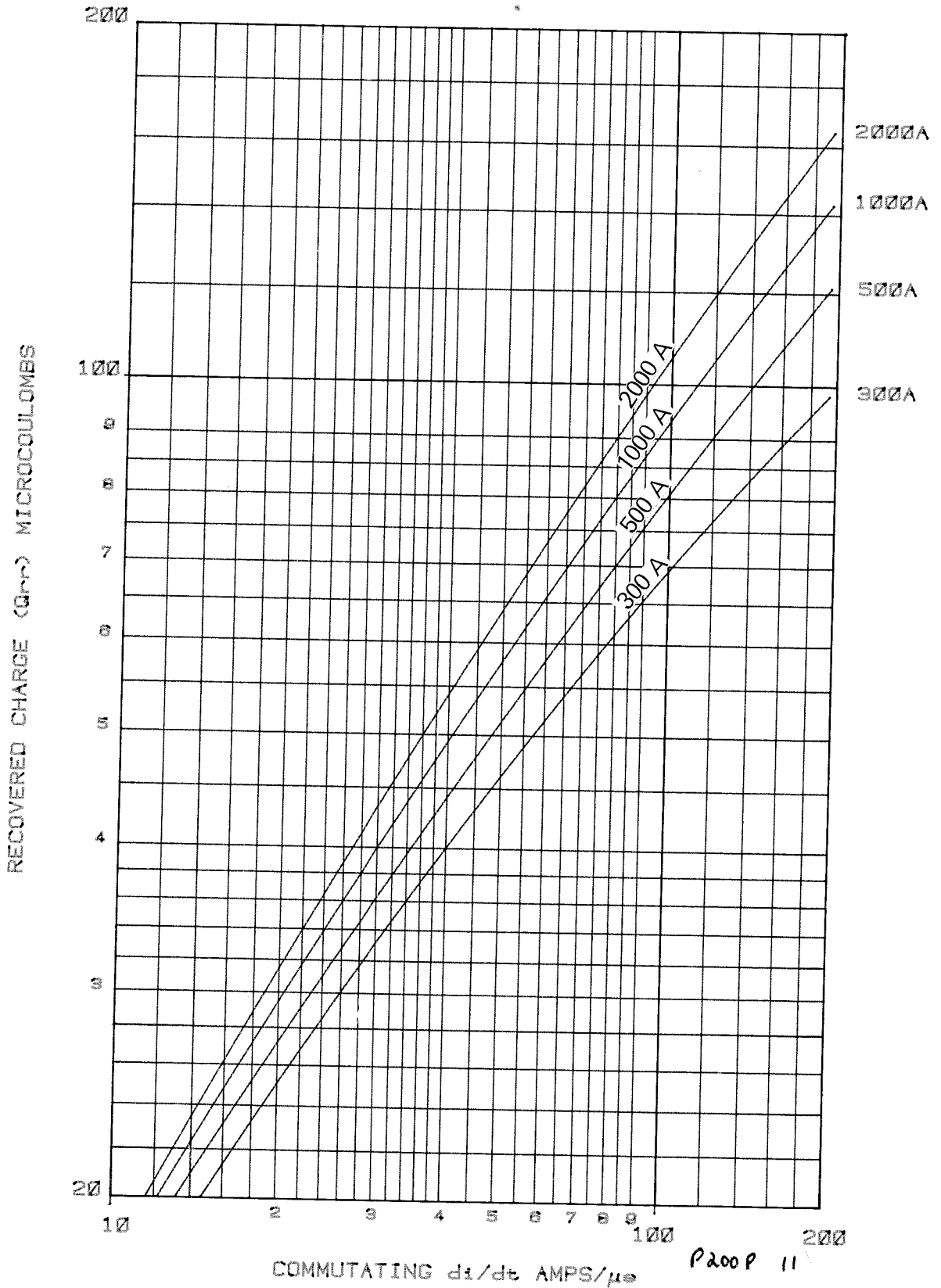

P300P  
Fig 7

MAXIMUM REVERSE RECOVERY ENERGY LOSS PER PULSE, 125°C JUNCTION TEMPERATURE

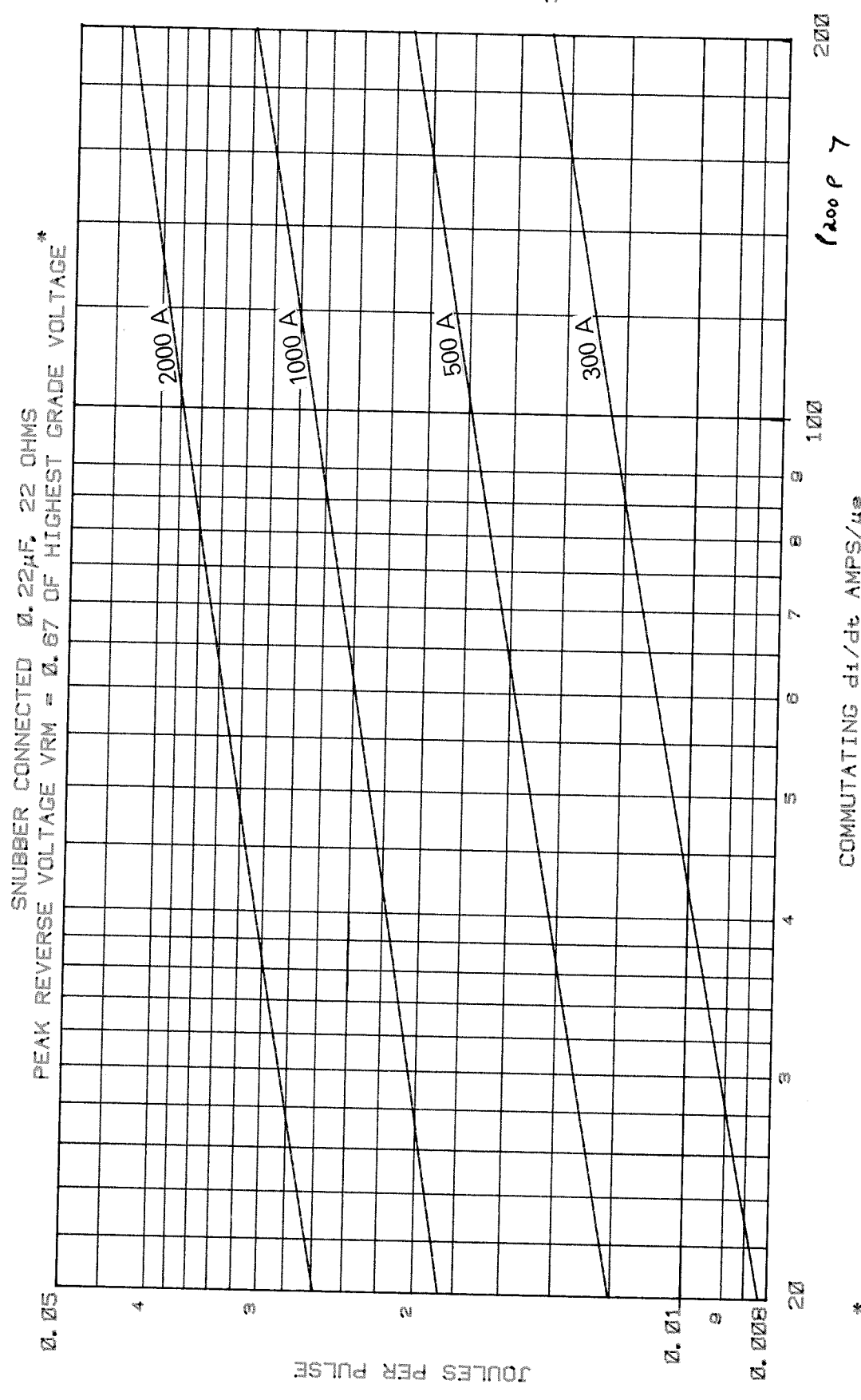

\* NOTE: ENERGY PER PULSE SHOULD BE ADJUSTED PRO RATA WITH APPLIED PEAK RECOVERY VOLTAGE

P200P  
Fig 1

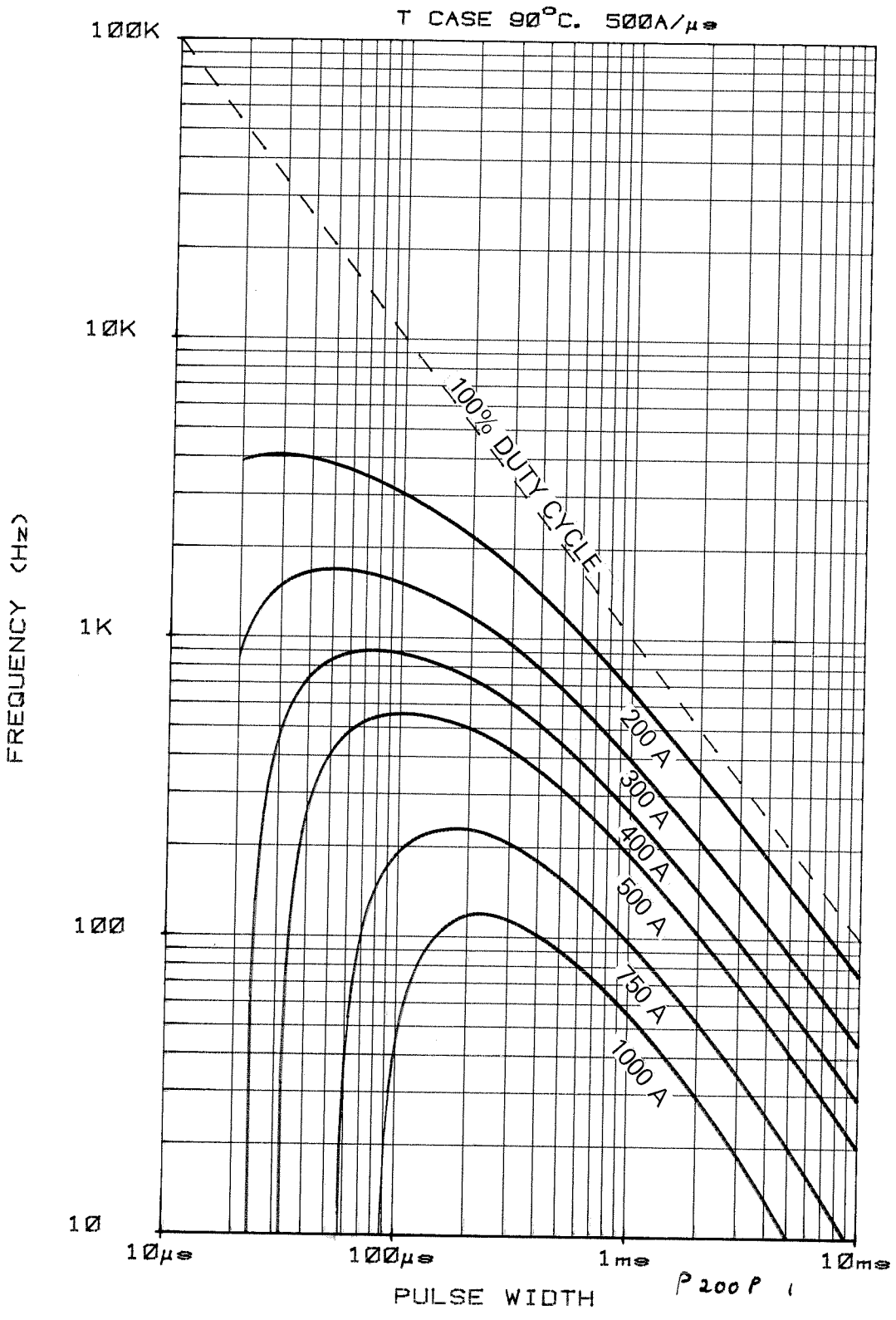



P900P  
FIG 3

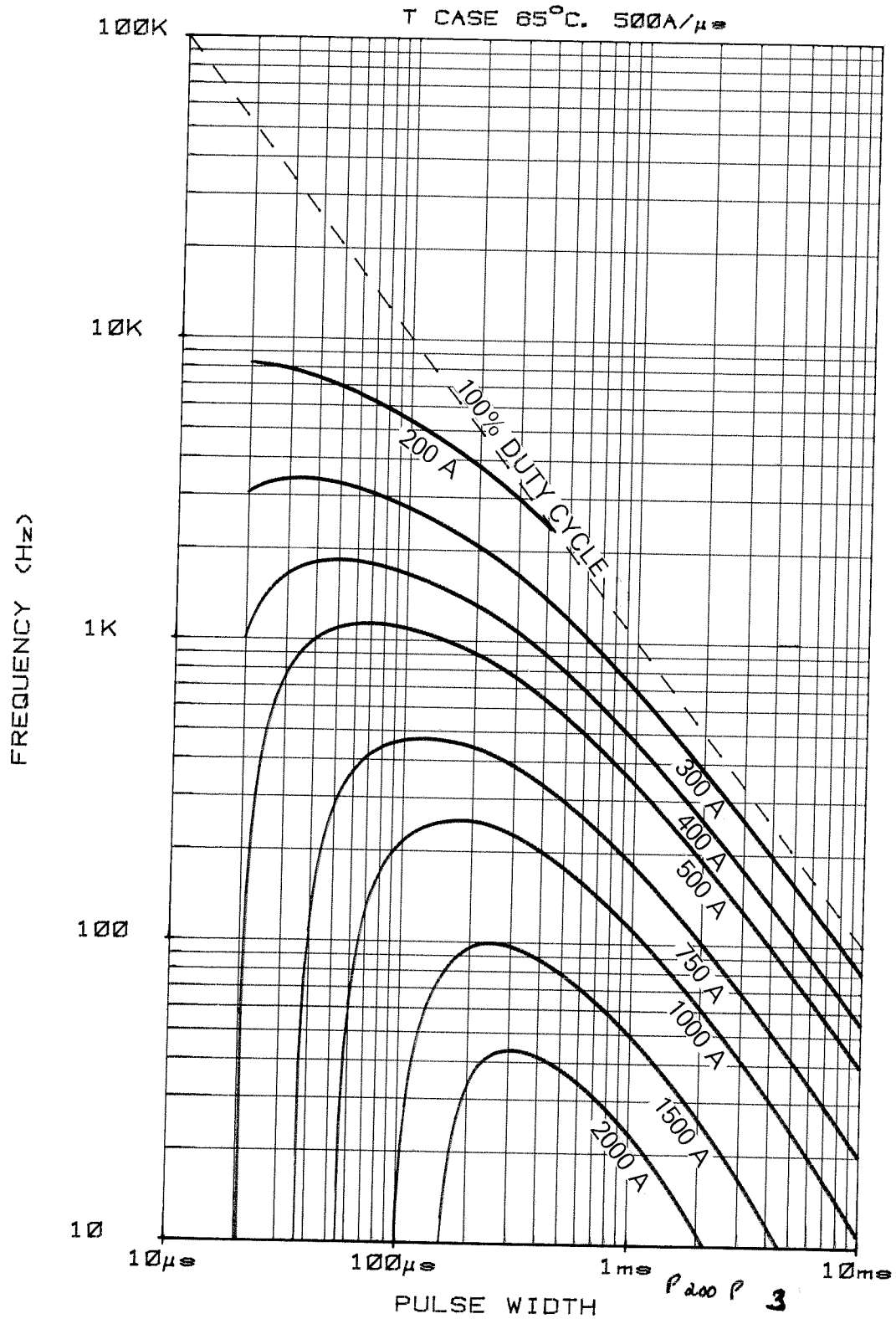

P200P  
Fig 2

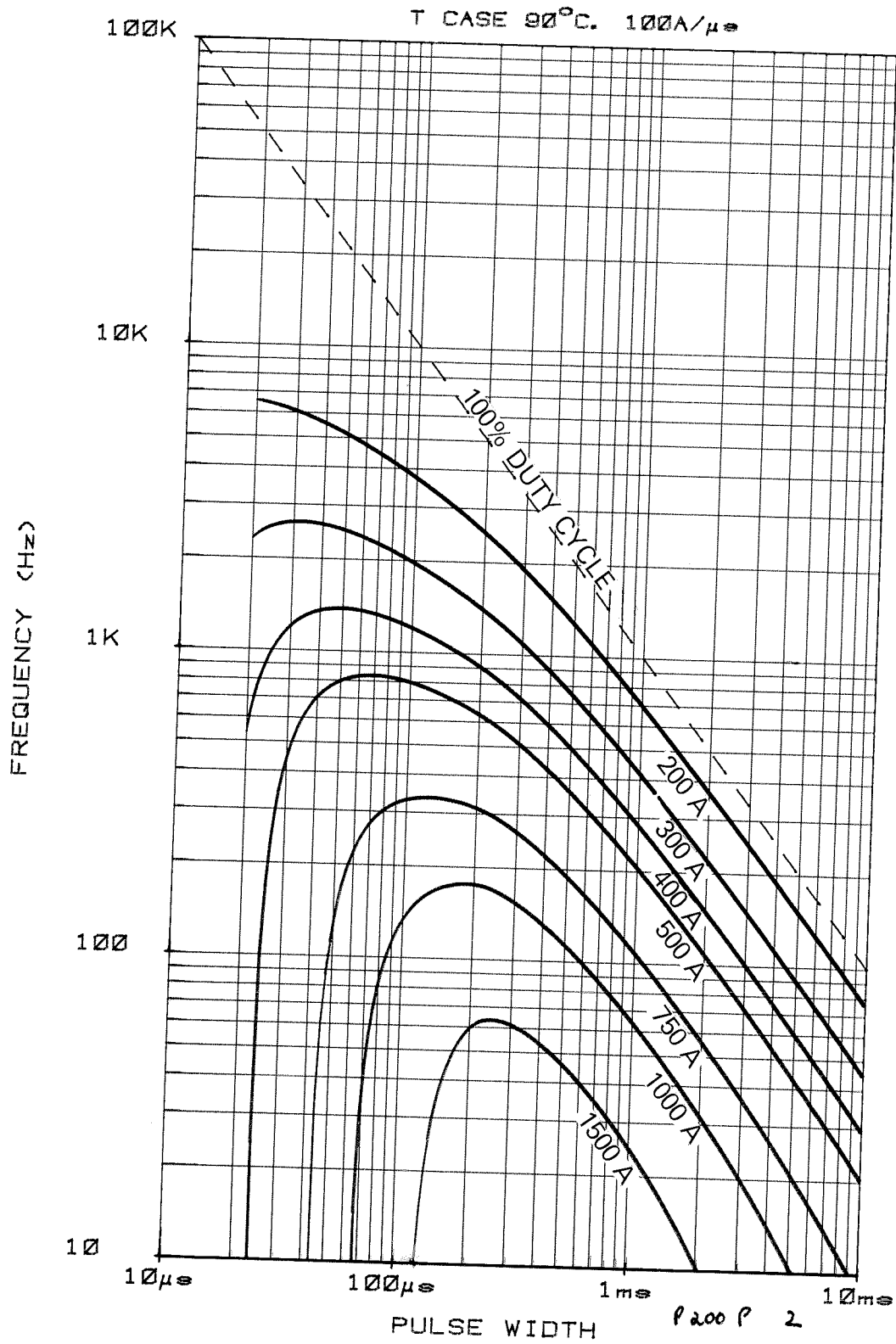

4/2001  
Fig 4

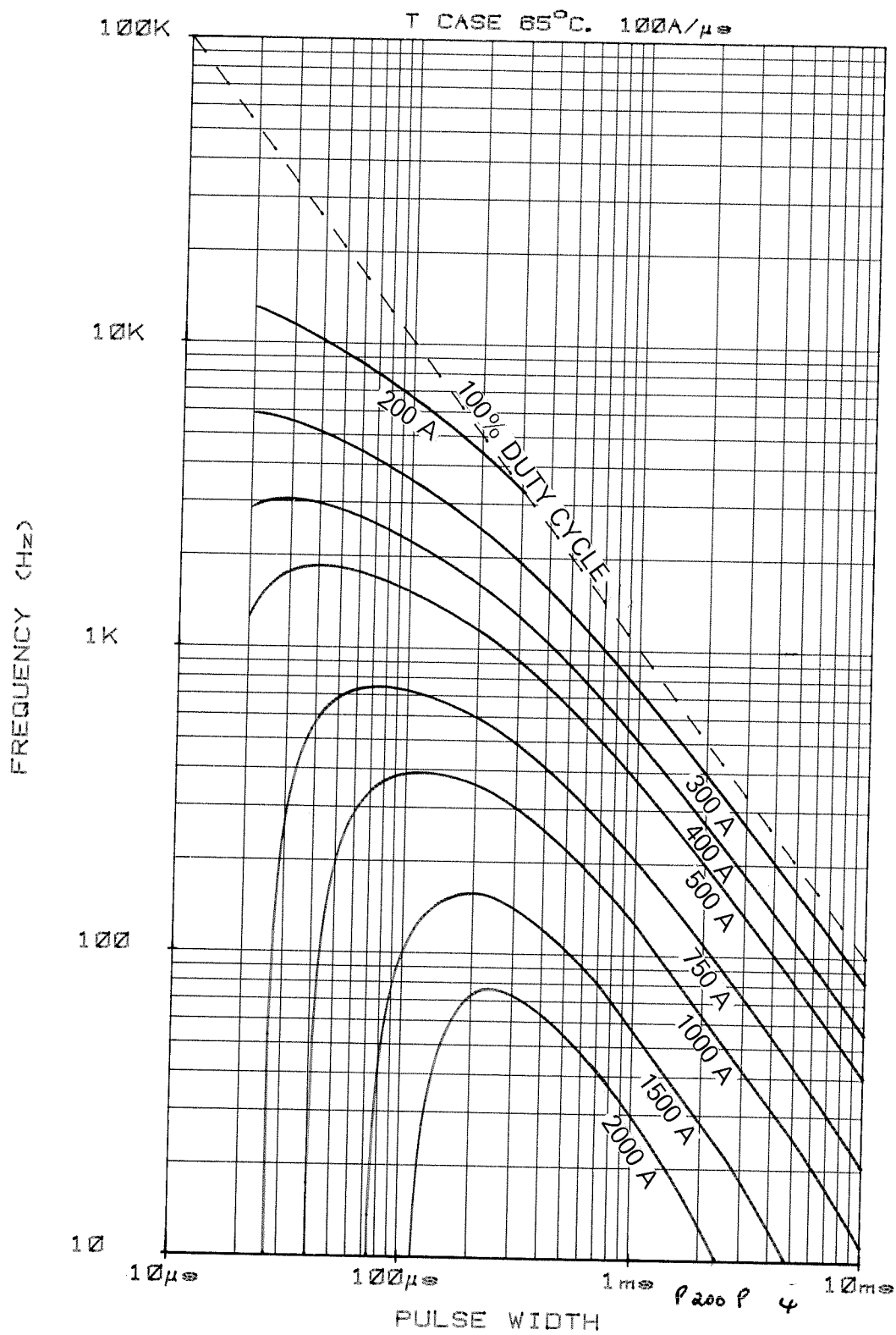

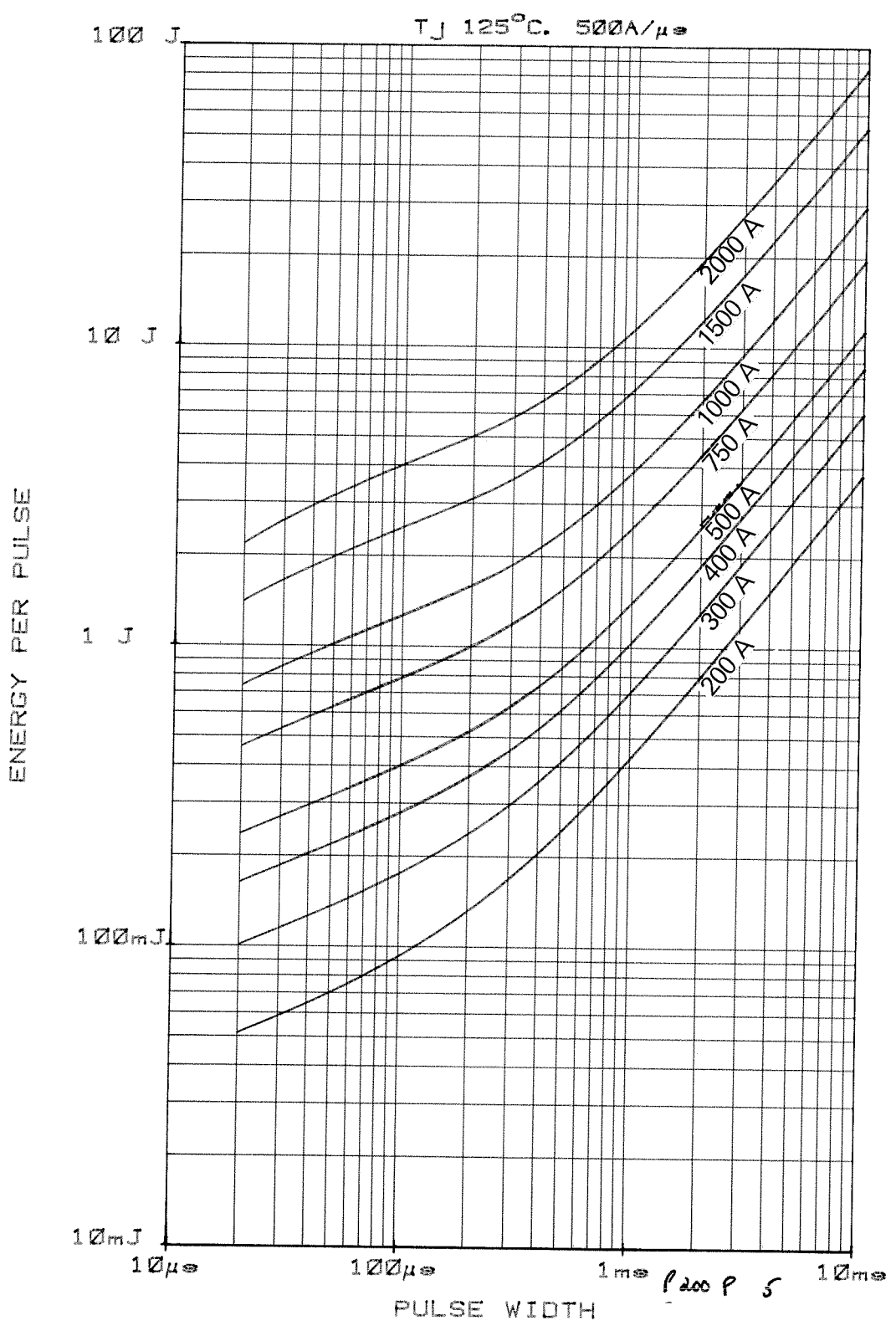

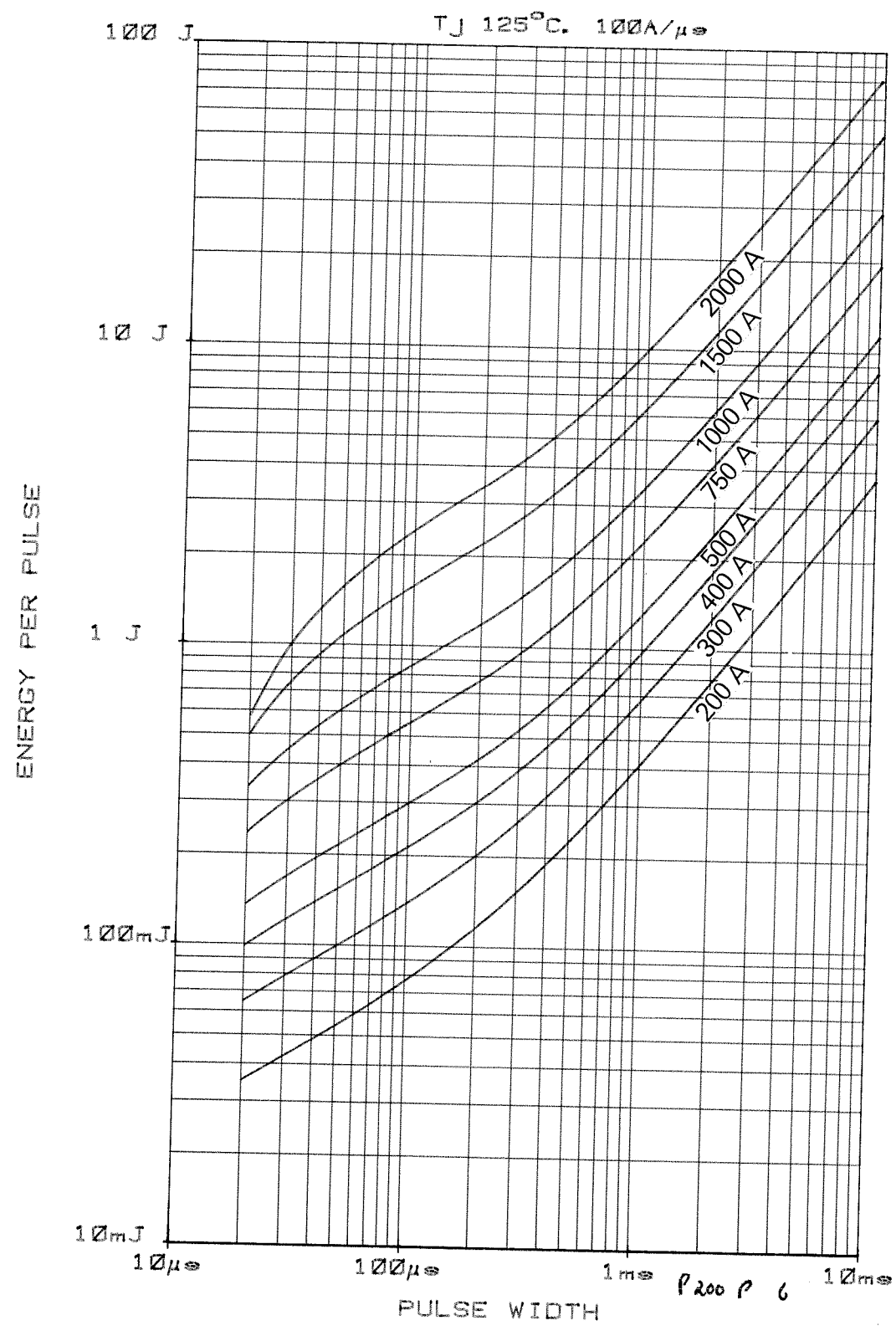

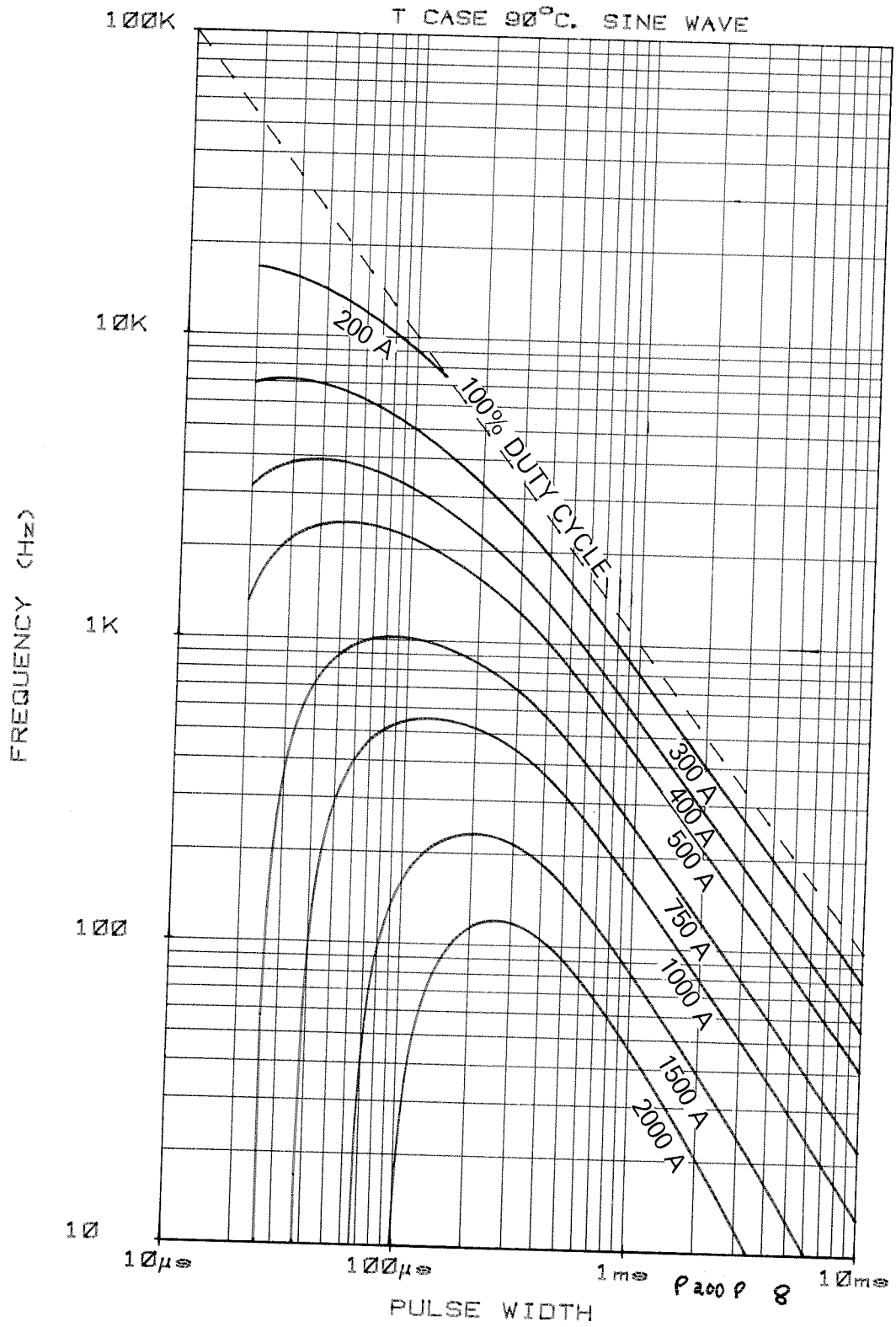

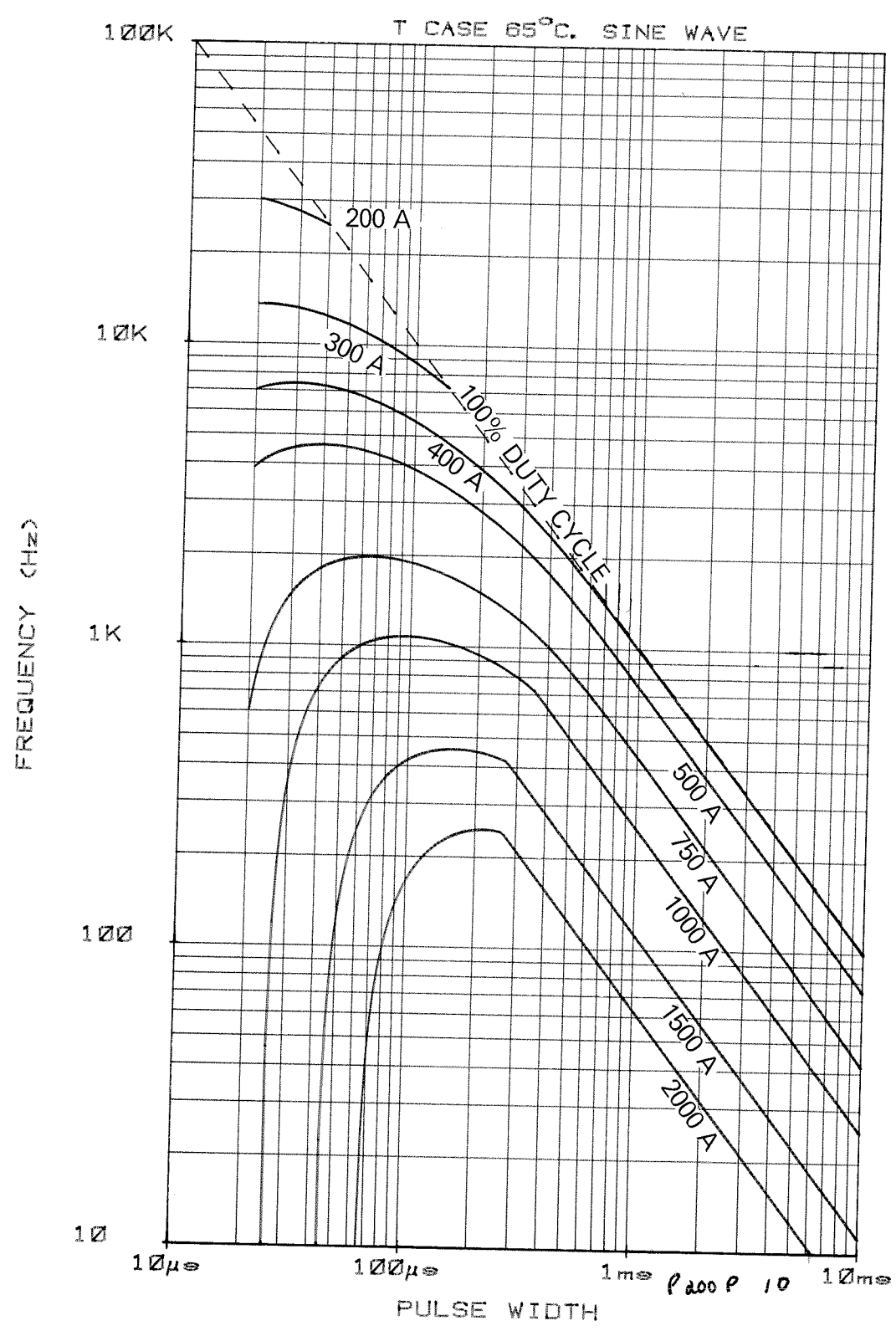

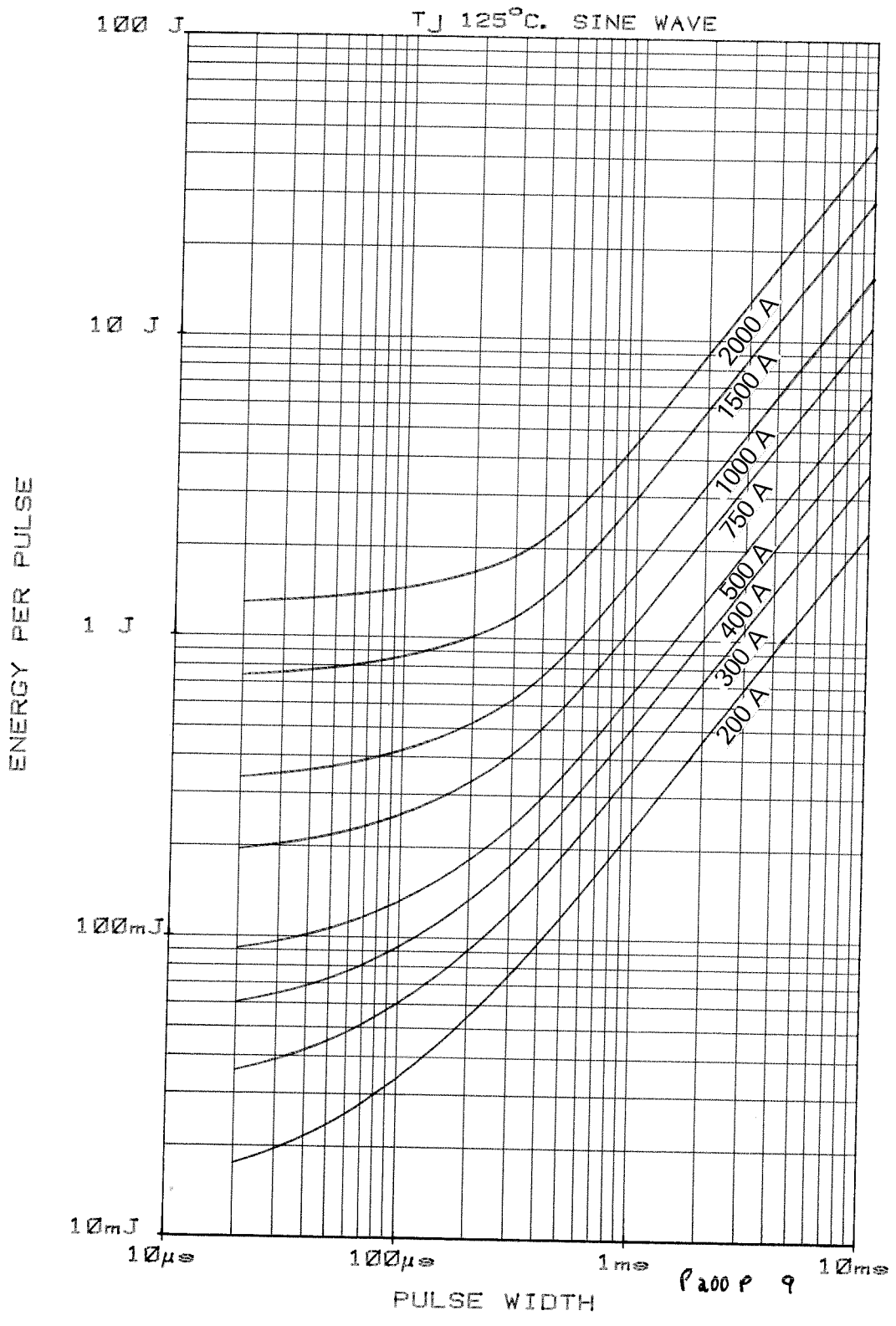



SCALE	1/1
DRN	RS
CHKD	
APPD	
S	A
S	NI

INTERNATIONAL OUTLINE No.  
 WEIGHT. 280 GRAMS APPX.  
 FINISH. BRIGHT NICKEL PLATE. - 24 -  
 DEVICE MARKING INCLUDES MONOGRAM, TYPE No., SPEC.  
 No. AND POLARITY SYMBOL.  
 DEVICE MOUNTING: MOUNTING TORQUE  
 27-24.5 Nm (2.77-2.5 kgf-m).  
 THREAD MUST NOT BE LUBRICATED.

TYPE NUMBER	
N170P	P205P
N195P	P215P
N275P	P202P
	P200P
	P204P
	P214P

NOTES.

G.A. DRG. No. 103A162

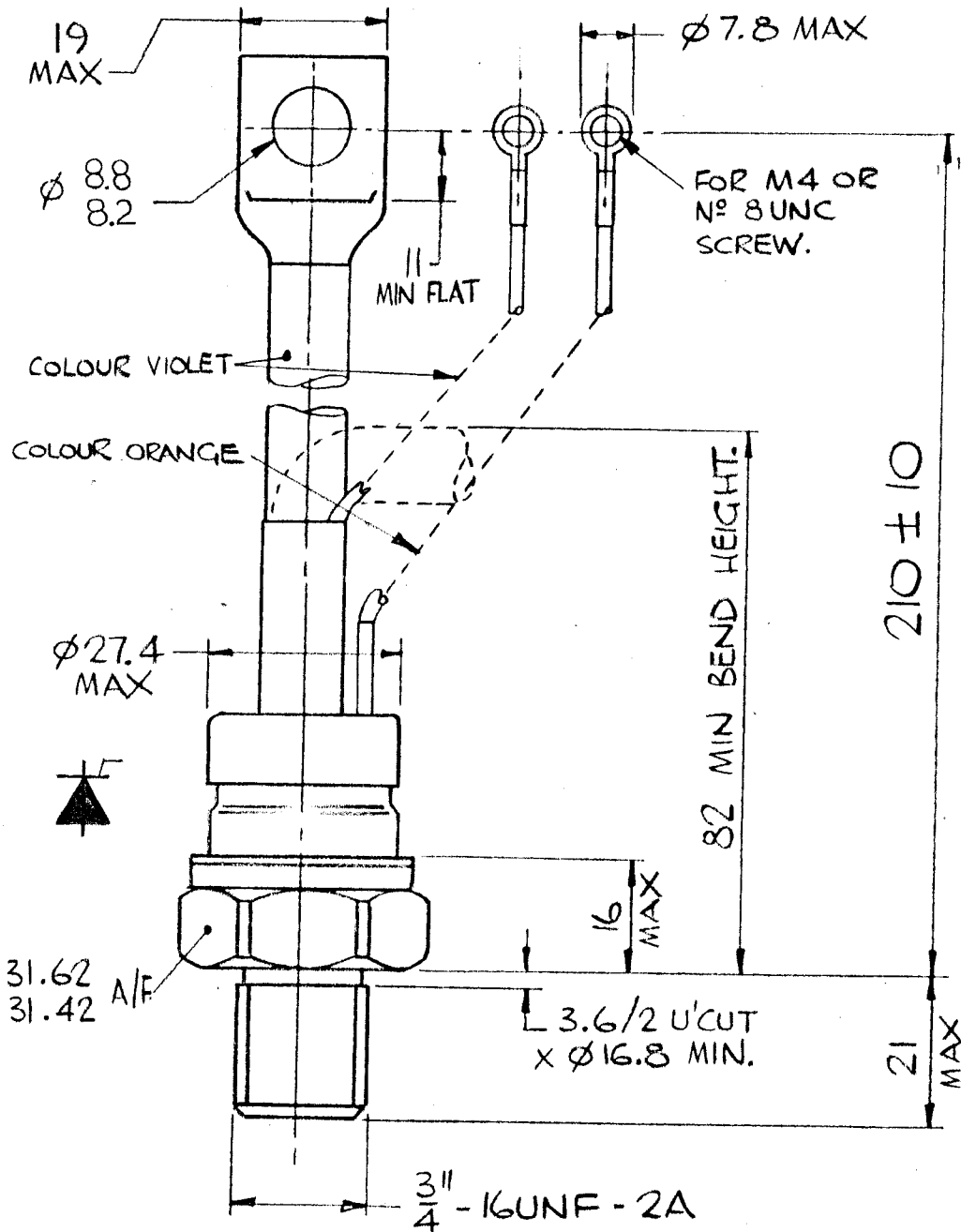

THE INFORMATION CONTAINED IN THIS DRAWING IS SUPPLIED IN CONFIDENCE AND IS PROTECTED BY COPYRIGHT. NO INFORMATION MAY NOT BE DISCLOSED EXCEPT WITH THE WRITTEN PERMISSION OF AND IN MANNER PERMITTED BY THE PROPRIETORS, WESTINGHOUSE BRAKE AND SIGNAL CO. LTD.

WESTINGHOUSE BRAKE AND SIGNAL CO. LTD.  
 CHIPPENHAM, WILTSHIRE, SN15 1JD, ENGLAND.

 WESTCODE®  
 SEMICONDUCTORS

THIRD ANGLE PROJECTION

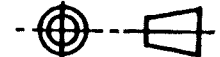

DIMNS. IN MILLIMETRES

DRG. No. 101A225

ISS	REVISIONS
1	19.9.78
2	17.11.78 W670 TYPE N° ADDED
3	Ø 8.8/8.2 HOLE WAS 10.7/10.2
4	17.12.79 M817 19 WAS 21.4
5	27.11.84 M218 FIN WAS ET.