



DZ37082D0L

Silicon epitaxial planar type

For surge absorption circuit
 DZ3S082D in SSSMini3 type package

■ Features

- Excellent rising characteristics of zener current I_Z
- Low zener operating resistance R_Z
- Halogen-free / RoHS compliant
 (EU RoHS / UL-94 V-0 / MSL:Level 1 compliant)

■ Marking Symbol:03

■ Packaging

Embossed type (Thermo-compression sealing) 10 000 pcs / reel (standard)

■ Absolute Maximum Ratings Ta = 25 °C

Parameter	Symbol	Rating	Unit
Total power dissipation ^{*1}	PT	150	mW
Electrostatic discharge ^{*2}	ESD	±10	kV
Junction temperature	T _j	150	°C
Operating ambient temperature	T _{opr}	-40 to +85	°C
Storage temperature	T _{stg}	-55 to +150	°C

Note) *1: Mounted on glass epoxy print board. (45 mm x 45 mm x 1 mm)

(2 Diode total)

Solder in (Recommended land pattern)

*2: Test method:IEC61000_4_2(C = 150 pF,R = 330 Ω, Contact discharge:10 times)

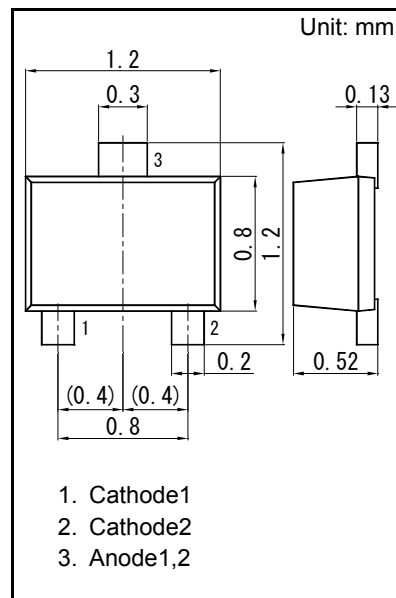

Panasonic	SSSMini3-F2-B
JEITA	SC-105AA
Code	SOT-723

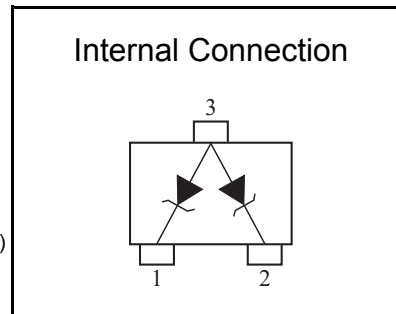

■ Electrical Characteristics Ta = 25 °C ± 3 °C

Parameter	Symbol	Conditions	Min	Typ	Max	Unit
Forward voltage	V _F	I _F = 10 mA			1.0	V
Zener voltage ^{*1, *2}	V _Z	I _Z = 5 mA	7.79		8.61	V
Zener operating resistance	R _Z	I _Z = 5 mA			30	Ω
Zener rise operating resistance	R _{ZK}	I _Z = 0.5 mA			60	Ω
Reverse current	I _R	V _R = 5 V			0.1	μA
Temperature coefficient of zener voltage ^{*3}	SZ	I _Z = 5 mA		4.8		mV/°C

Note) 1. Measuring methods are based on JAPANESE INDUSTRIAL STANDARD JIS C 7031 Measuring methods for Diodes.

2. *1: The temperature must be controlled 25°C for V_Z measurement.

V_Z value measured at other temperature must be adjusted to V_Z (25°C)

*2: V_Z guaranteed 20 ms after current flow.

*3: T_j = 25°C to 150°C

Technical Data (reference)

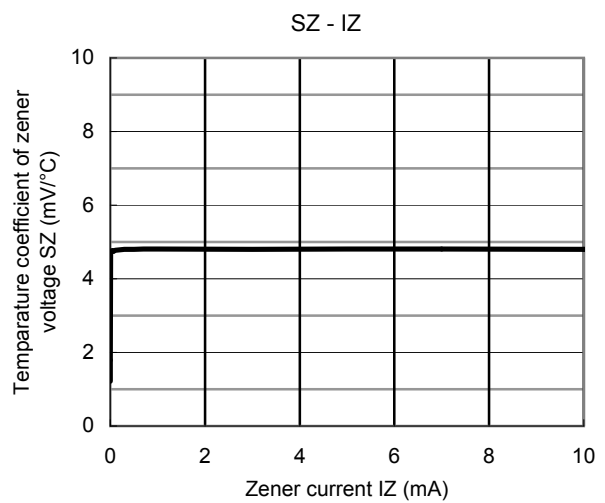
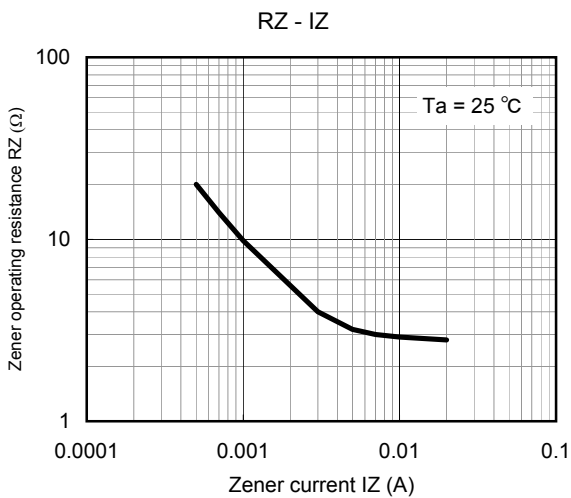
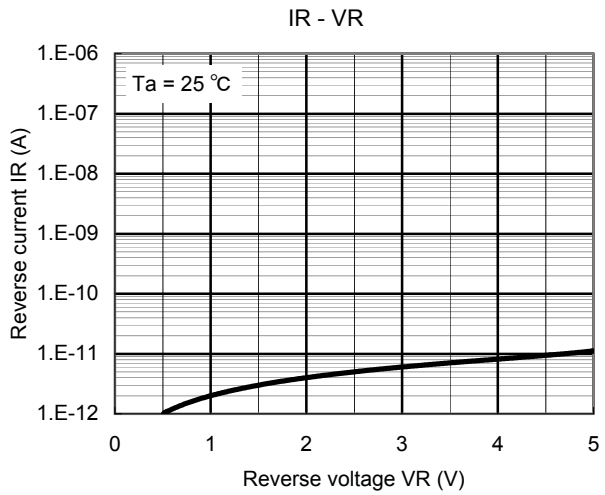
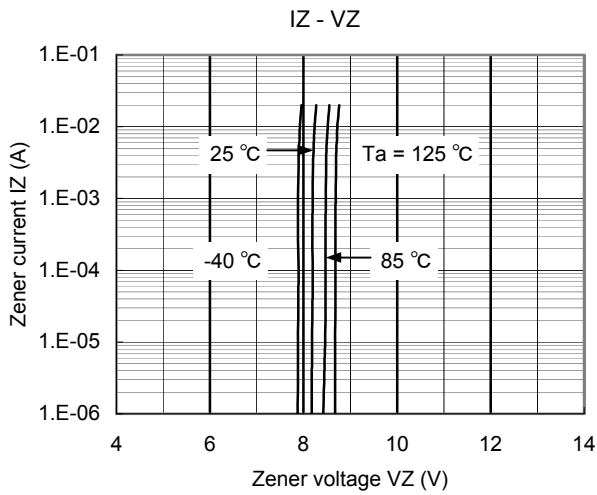
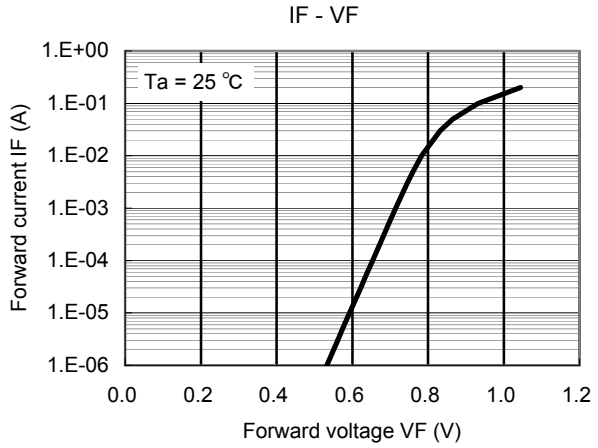
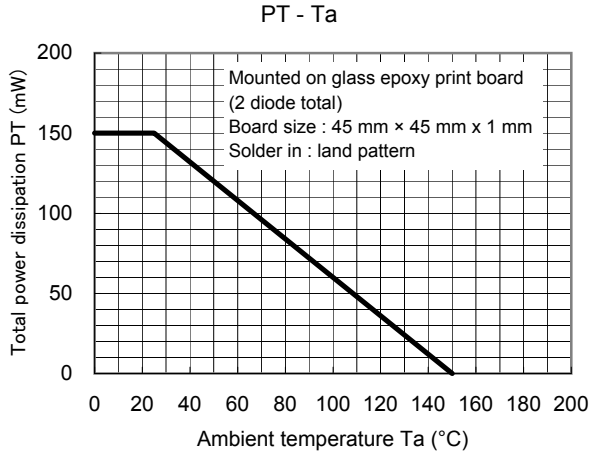



Technical Data (reference)

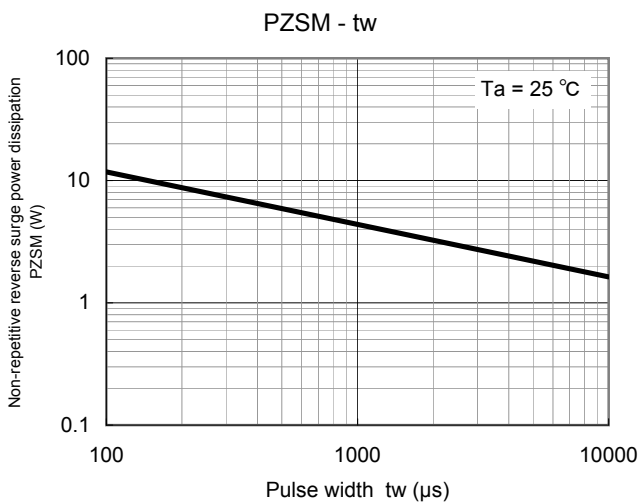
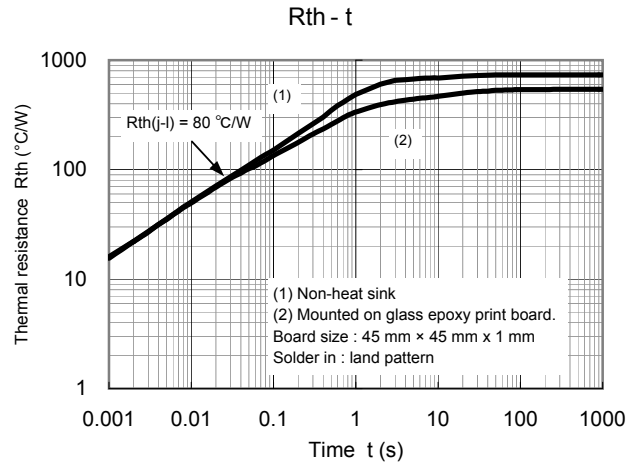
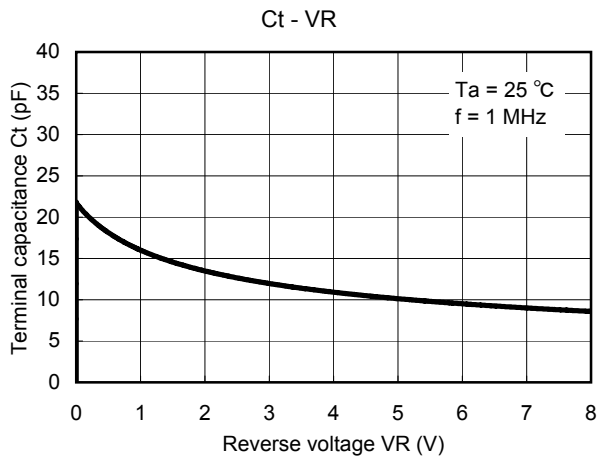

SSSMini3-F2-B

Unit: mm

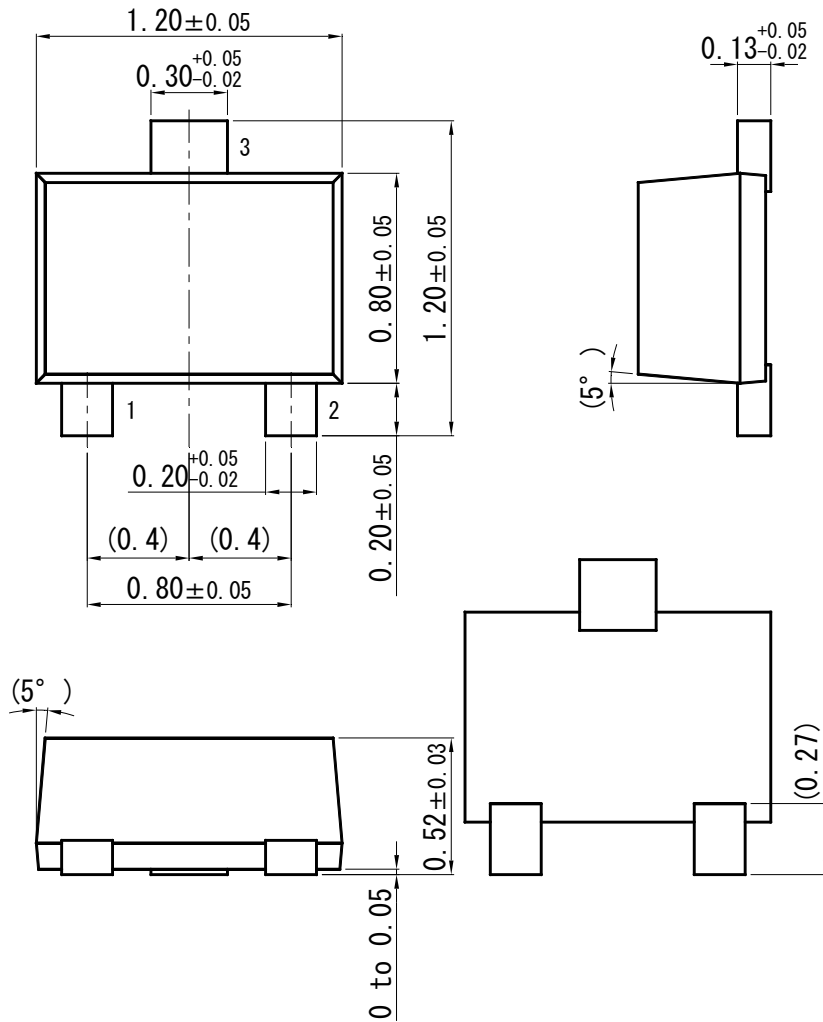

■ Land Pattern (Reference) (Unit: mm)

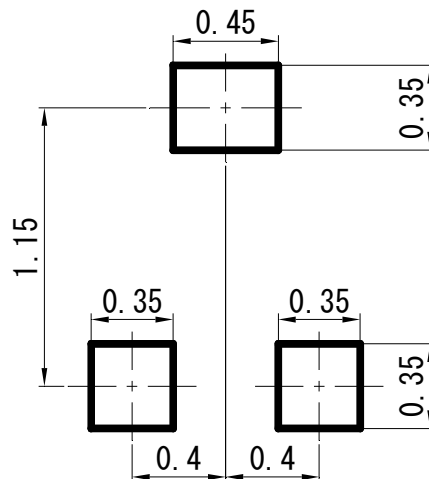

Request for your special attention and precautions in using the technical information and semiconductors described in this book

- (1) If any of the products or technical information described in this book is to be exported or provided to non-residents, the laws and regulations of the exporting country, especially, those with regard to security export control, must be observed.
- (2) The technical information described in this book is intended only to show the main characteristics and application circuit examples of the products. No license is granted in and to any intellectual property right or other right owned by Panasonic Corporation or any other company. Therefore, no responsibility is assumed by our company as to the infringement upon any such right owned by any other company which may arise as a result of the use of technical information described in this book.
- (3) The products described in this book are intended to be used for general applications (such as office equipment, communications equipment, measuring instruments and household appliances), or for specific applications as expressly stated in this book.
Consult our sales staff in advance for information on the following applications:
 - Special applications (such as for airplanes, aerospace, automotive equipment, traffic signaling equipment, combustion equipment, life support systems and safety devices) in which exceptional quality and reliability are required, or if the failure or malfunction of the products may directly jeopardize life or harm the human body.It is to be understood that our company shall not be held responsible for any damage incurred as a result of or in connection with your using the products described in this book for any special application, unless our company agrees to your using the products in this book for any special application.
- (4) The products and product specifications described in this book are subject to change without notice for modification and/or improvement. At the final stage of your design, purchasing, or use of the products, therefore, ask for the most up-to-date Product Standards in advance to make sure that the latest specifications satisfy your requirements.
- (5) When designing your equipment, comply with the range of absolute maximum rating and the guaranteed operating conditions (operating power supply voltage and operating environment etc.). Especially, please be careful not to exceed the range of absolute maximum rating on the transient state, such as power-on, power-off and mode-switching. Otherwise, we will not be liable for any defect which may arise later in your equipment.
Even when the products are used within the guaranteed values, take into the consideration of incidence of break down and failure mode, possible to occur to semiconductor products. Measures on the systems such as redundant design, arresting the spread of fire or preventing glitch are recommended in order to prevent physical injury, fire, social damages, for example, by using the products.
- (6) Comply with the instructions for use in order to prevent breakdown and characteristics change due to external factors (ESD, EOS, thermal stress and mechanical stress) at the time of handling, mounting or at customer's process. When using products for which damp-proof packing is required, satisfy the conditions, such as shelf life and the elapsed time since first opening the packages.
- (7) This book may be not reprinted or reproduced whether wholly or partially, without the prior written permission of our company.