



Features

- 1W Power Dissipation on FR-4 PCB
- Large, exposed pad and heat sink designed for superior thermal performance
- **Lead-Free Finish; RoHS Compliant (Notes 1 & 2)**
- **Halogen and Antimony Free. "Green" Device (Note 3)**
- **Qualified to AEC-Q101 Standards for High Reliability**
- **Patented Interlocking Clip Design for High Surge Capacity, US Patent #7,095,113**

Mechanical Data

- Case: POWERDI123
- Case Material: Molded Plastic, "Green" Molding Compound. UL Flammability Classification Rating 94V-0
- Moisture Sensitivity: Level 1 per J-STD-020
- Terminal Connections: Cathode Band
- Terminals: Finish - Matte Tin annealed over Copper leadframe. Solderable per MIL-STD-202, Method 208 ②③
- Weight: 0.01 grams (approximate)

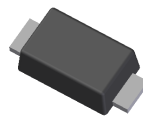

Top View

Ordering Information (Note 4)

Part Number	Qualification	Case	Packaging
(Type Number)Q-7*	Automotive	POWERDI®123	3000/Tape & Reel

* Add "-7" to the appropriate type number in Electrical Characteristics Table. Example: 6.2V Zener = DFLZ6V2Q-7

- Notes:
1. EU Directive 2002/95/EC (RoHS) & 2011/65/EU (RoHS 2) compliant. All applicable RoHS exemptions applied.
 2. See http://www.diodes.com/quality/lead_free.html for more information about Diodes Incorporated's definitions of Halogen- and Antimony-free, "Green" and Lead-free.
 3. Halogen- and Antimony-free "Green" products are defined as those which contain <900ppm bromine, <900ppm chlorine (<1500ppm total Br + Cl) and <1000ppm antimony compounds.
 4. For packaging details, go to our website at <http://www.diodes.com/products/packages.html>.

Marking Information

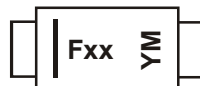

Fxx = Product Type Marking Code
(See Electrical Characteristics Table)
YM = Date Code Marking
Y = Year (ex: A = 2013)
M = Month (ex: 9 = September)

Date Code Key

Year	2007	2008	2009	2010	2011	2012	2013	2014	2015	2016	2017	2018
Code	U	V	W	X	Y	Z	A	B	C	D	E	F
Month	Jan	Feb	Mar	Apr	May	Jun	Jul	Aug	Sep	Oct	Nov	Dec
Code	1	2	3	4	5	6	7	8	9	O	N	D

Maximum Ratings (@T_A = +25°C, unless otherwise specified.)

Characteristic	Symbol	Value	Unit
Forward Voltage @ I _F = 200mA	V _F	1.2	V

Thermal Characteristics

Characteristic	Symbol	Typ	Value	Unit
Power Dissipation (Note 5)	P _D	—	1.0	W
Thermal Resistance Junction to Ambient Air (Note 5)	R _{θJA}	110	—	°C/W
Thermal Resistance Junction to Soldering Point (Note 6)	R _{θJS}	—	9	°C/W
Operating and Storage Temperature Range	T _J , T _{STG}	—	-55 to +150	°C

Electrical Characteristics (@T_A = +25°C, unless otherwise specified.)

Type Number	Marking Codes	Zener Voltage Range (Note 7)				Zener Impedance (Note 8)		Maximum Reverse Current (Note 7)		Temperature Coefficient @ I _{ZTC} %/°C	
		V _Z @ I _{ZT}			I _{ZT}	Z _{ZT} @ I _{ZT}		I _R	@ V _R	Min	Max
		Nom (V)	Min (V)	Max (V)	mA	Typ (Ω)	Max (Ω)	μA	V		
DFLZ5V1Q	FHK	5.1	4.8	5.4	100	2	6	2.5	1	-0.08	-0.2
DFLZ5V6Q	FHL	5.6	5.2	6.0	100	1	4	10	2	-0.04	0.04
DFLZ6V2Q	FHN	6.2	5.8	6.6	100	1	3	5	2	-0.01	0.06
DFLZ6V8Q	FHO	6.8	6.4	7.2	100	1	3	5	3	0	0.07
DFLZ7V5Q	FHQ	7.5	7.0	7.9	100	1	2	5	3	0	0.07
DFLZ8V2Q	FHR	8.2	7.7	8.7	100	1	2	5	3	0.03	0.08
DFLZ9V1Q	FHT	9.1	8.5	9.6	50	1	4	5	5	0.03	0.08
DFLZ10Q	FHU	10	9.4	10.6	50	1	4	5	7.5	0.05	0.09
DFLZ11Q	FHV	11	10.4	11.6	50	1	7	4	8.2	0.05	0.10
DFLZ12Q	FHW	12	11.4	12.7	50	1	7	3	9.1	0.05	0.10
DFLZ13Q	FHX	13	12.4	14.1	50	1	10	2	10	0.05	0.10
DFLZ15Q	FHZ	15	13.8	15.6	50	1	10	1	11	0.05	0.10
DFLZ16Q	FJA	16	15.3	17.1	25	1	15	1	12	0.06	0.11
DFLZ18Q	FJF	18	16.8	19.1	25	2	15	1	13	0.06	0.11
DFLZ20Q	FJG	20	18.8	21.2	25	3	15	1	15	0.06	0.11
DFLZ22Q	FJK	22	20.8	23.3	25	3	15	1	16	0.06	0.11
DFLZ24Q	FJL	24	22.8	25.6	25	2	15	1	18	0.06	0.11
DFLZ27Q	FJN	27	25.1	28.9	25	3	15	1	20	0.06	0.11
DFLZ30Q	FJQ	30	28	32	25	8	15	1	22	0.06	0.11
DFLZ33Q	FJR	33	31	35	25	5	15	1	24	0.06	0.11
DFLZ36Q	FJS	36	34	38	10	5	40	1	27	0.06	0.11
DFLZ39Q	FJT	39	37	41	10	5	40	1	30	0.06	0.11

Notes: 5. Device mounted on 1" x 1", FR-4 PCB; 2 oz. Cu pad layout as shown on Diodes Inc. suggested pad layout document AP02001.pdf at <http://www.diodes.com>.

6. Theoretical R_{θJS} calculated from the top center of the die straight down to the PCB/cathode tab solder junction.

7. Short duration pulse test used to minimize self-heating effect.

8. The Zener impedance (Z_{ZT}) is measured by superimposing a minute alternating current on the regulated current (I_{ZT}).

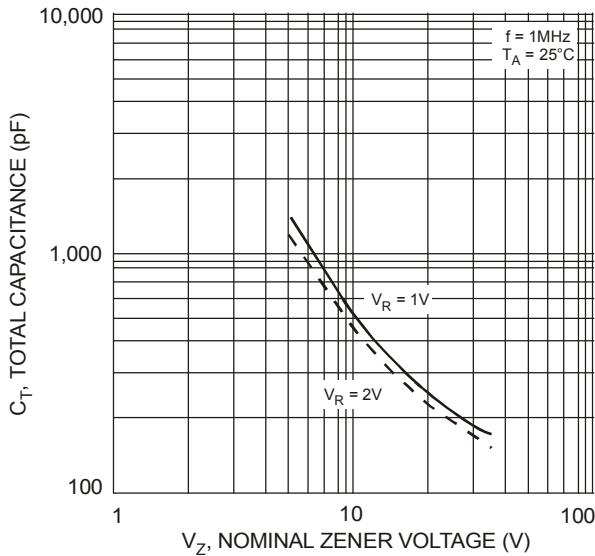
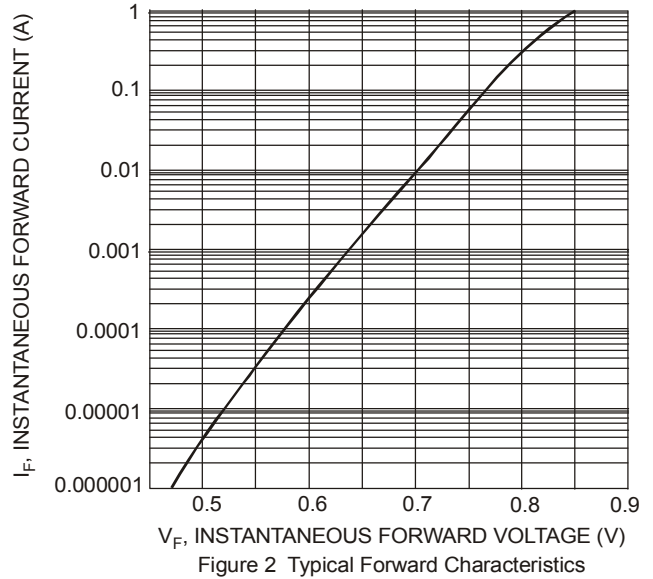
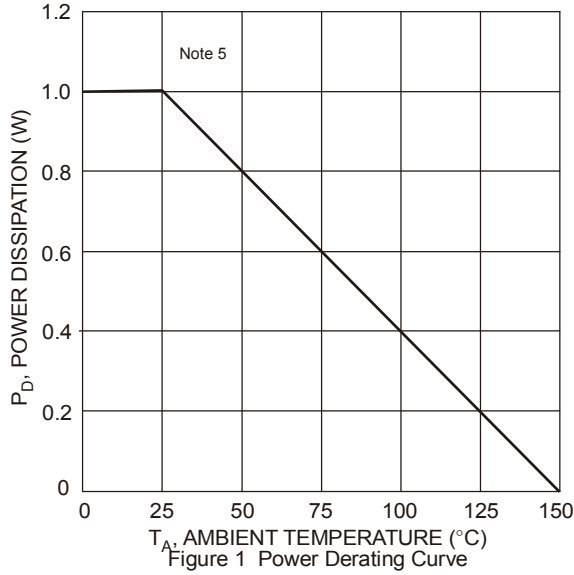

Package Outline Dimensions

Please see AP02002 at <http://www.diodes.com/datasheets/ap02002.pdf> for latest version.

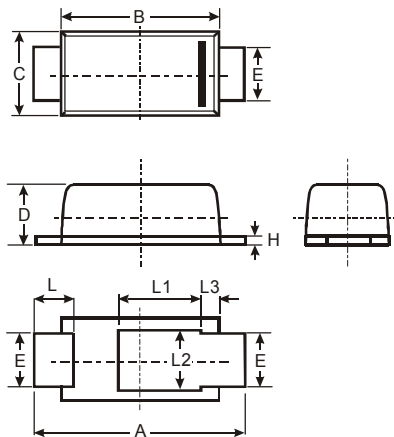

POWERDI [®] 123			
Dim	Min	Max	Typ
A	3.50	3.90	3.70
B	2.60	3.00	2.80
C	1.63	1.93	1.78
D	0.93	1.00	0.98
E	0.85	1.25	1.00
H	0.15	0.25	0.20
L	0.40	0.50	0.45
L1	-	-	1.35
L2	-	-	1.10
L3	-	-	0.20

All Dimensions in mm

Suggested Pad Layout

Please see AP02001 at <http://www.diodes.com/datasheets/ap02001.pdf> for the latest version.

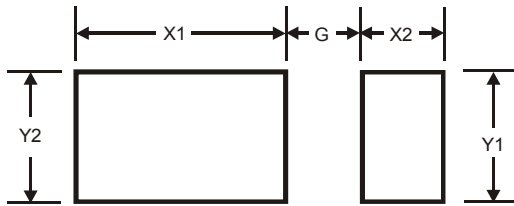

Dimensions	Value (in mm)
G	1.0
X1	2.2
X2	0.9
Y1	1.4
Y2	1.4

IMPORTANT NOTICE

DIODES INCORPORATED MAKES NO WARRANTY OF ANY KIND, EXPRESS OR IMPLIED, WITH REGARDS TO THIS DOCUMENT, INCLUDING, BUT NOT LIMITED TO, THE IMPLIED WARRANTIES OF MERCHANTABILITY AND FITNESS FOR A PARTICULAR PURPOSE (AND THEIR EQUIVALENTS UNDER THE LAWS OF ANY JURISDICTION).

Diodes Incorporated and its subsidiaries reserve the right to make modifications, enhancements, improvements, corrections or other changes without further notice to this document and any product described herein. Diodes Incorporated does not assume any liability arising out of the application or use of this document or any product described herein; neither does Diodes Incorporated convey any license under its patent or trademark rights, nor the rights of others. Any Customer or user of this document or products described herein in such applications shall assume all risks of such use and will agree to hold Diodes Incorporated and all the companies whose products are represented on Diodes Incorporated website, harmless against all damages.

Diodes Incorporated does not warrant or accept any liability whatsoever in respect of any products purchased through unauthorized sales channel. Should Customers purchase or use Diodes Incorporated products for any unintended or unauthorized application, Customers shall indemnify and hold Diodes Incorporated and its representatives harmless against all claims, damages, expenses, and attorney fees arising out of, directly or indirectly, any claim of personal injury or death associated with such unintended or unauthorized application.

Products described herein may be covered by one or more United States, international or foreign patents pending. Product names and markings noted herein may also be covered by one or more United States, international or foreign trademarks.

This document is written in English but may be translated into multiple languages for reference. Only the English version of this document is the final and determinative format released by Diodes Incorporated.

LIFE SUPPORT

Diodes Incorporated products are specifically not authorized for use as critical components in life support devices or systems without the express written approval of the Chief Executive Officer of Diodes Incorporated. As used herein:

A. Life support devices or systems are devices or systems which:

1. are intended to implant into the body, or
2. support or sustain life and whose failure to perform when properly used in accordance with instructions for use provided in the labeling can be reasonably expected to result in significant injury to the user.

B. A critical component is any component in a life support device or system whose failure to perform can be reasonably expected to cause the failure of the life support device or to affect its safety or effectiveness.

Customers represent that they have all necessary expertise in the safety and regulatory ramifications of their life support devices or systems, and acknowledge and agree that they are solely responsible for all legal, regulatory and safety-related requirements concerning their products and any use of Diodes Incorporated products in such safety-critical, life support devices or systems, notwithstanding any devices- or systems-related information or support that may be provided by Diodes Incorporated. Further, Customers must fully indemnify Diodes Incorporated and its representatives against any damages arising out of the use of Diodes Incorporated products in such safety-critical, life support devices or systems.

Copyright © 2014, Diodes Incorporated

www.diodes.com