

Power Schottky rectifier

Features

- Low forward voltage drop
- Negligible switching losses
- Low thermal resistance
- Avalanche capability specified

Description

These dual center tap Schottky rectifiers are suited for switch mode power supplies and high frequency DC to DC converters.

Packaged in D²PAK, I²PAK and TO-220AB, this device is intended for use in low voltage, high frequency inverters, free-wheeling and polarity protection applications.

Figure 1. Electrical characteristics (a)

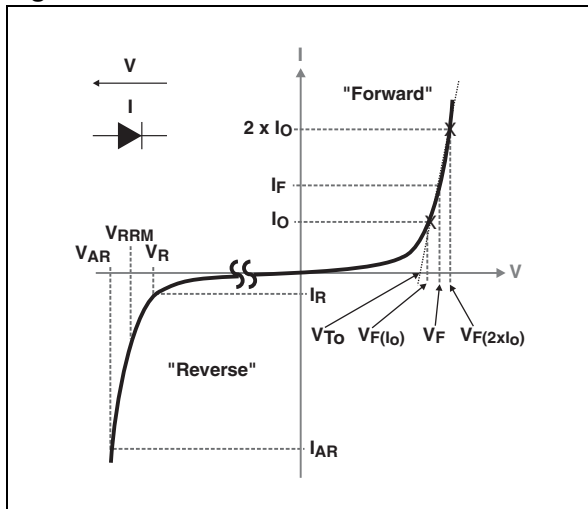

- a. V_{ARM} and I_{ARM} must respect the reverse safe operating area defined in [Figure 12](#). V_{AR} and I_{AR} are pulse measurements ($t_p < 1 \mu s$). V_R , I_R , V_{RRM} and V_F are static characteristics

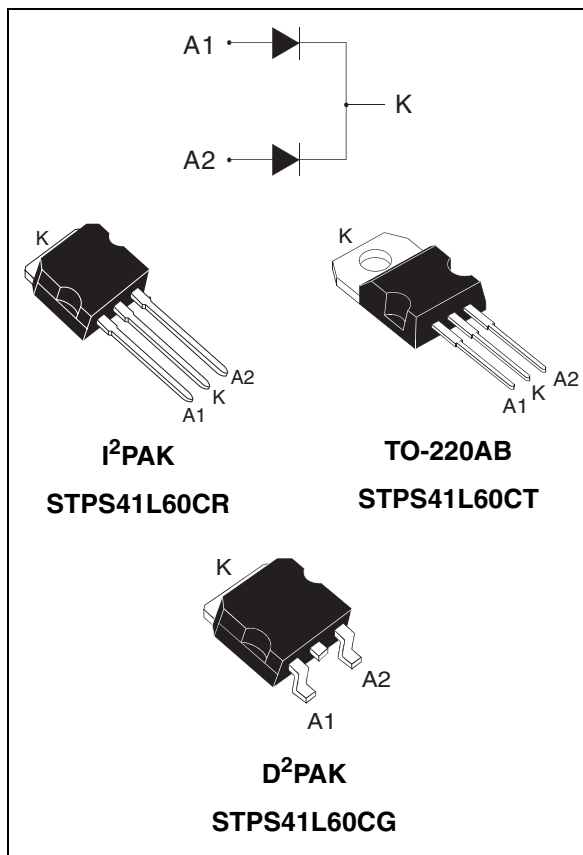

Table 1. Device summary

$I_{F(AV)}$	2 x 20 A
V_{RRM}	60 V
$T_j(max)$	150 °C
$V_F(max)$	0.58 V

1 Characteristics

Table 2. Absolute ratings (limiting values, per diode)

Symbol	Parameter		Value	Unit	
V _{RRM}	Repetitive peak reverse voltage		60	V	
I _{F(RMS)}	Forward rms current		30	A	
I _{F(AV)}	Average forward current	T _C = 125 °C δ = 0.5	Per diode Per device	20 40	A
I _{FSM}	Surge non repetitive forward current		tp = 10 ms Sinusoidal	220	A
P _{ARM} ⁽¹⁾	Repetitive peak avalanche power		tp = 1 μs T _j = 25 °C	9500	W
V _{ARM} ⁽²⁾	Maximum repetitive peak avalanche voltage		t _p < 1 μs, T _j < 150 °C, I _{AR} < 35 A	80	V
V _{ASM} ⁽²⁾	Maximum single pulse peak avalanche voltage		t _p < 1 μs, T _j < 150 °C, I _{AR} < 35 A	80	V
T _{stg}	Storage temperature range		-65 to + 175	°C	
T _j	Maximum operating junction temperature ⁽³⁾		150	°C	

1. For temperature or pulse time duration deratings, refer to [Figure 4](#) and [Figure 5](#). More details regarding the avalanche energy measurements and diode validation in the avalanche are provided in the application notes AN1768 and AN2025.
2. Refer to [Figure 12](#)
3. $\frac{dP_{tot}}{dT_j} < \frac{1}{R_{th(j-a)}}$ condition to avoid thermal runaway for a diode on its own heatsink

Table 3. Thermal resistances

Symbol	Parameter		Value	Unit
R _{th(j-c)}	Junction to case	Per diode	1.5	°C/W
		Total	0.8	
R _{th(c)}	Coupling		0.1	

When the diodes 1 and 2 are used simultaneously :
 $\Delta T_j(\text{diode 1}) = P(\text{diode1}) \times R_{th(j-c)}(\text{Per diode}) + P(\text{diode 2}) \times R_{th(c)}$

Table 4. Static electrical characteristics (per diode)

Symbol	Parameter	Tests conditions		Min.	Typ.	Max.	Unit
I _R ⁽¹⁾	Reverse leakage current	T _j = 25 °C	V _R = V _{RRM}			600	μA
		T _j = 125 °C			100	175	mA
V _F ⁽¹⁾	Forward voltage drop	T _j = 25 °C	I _F = 20 A			0.60	V
		T _j = 125 °C	I _F = 20 A		0.50	0.58	
		T _j = 25 °C	I _F = 40A			0.77	
		T _j = 125 °C	I _F = 40A		0.67	0.71	

1. Pulse test: t_p = 380 μs, δ < 2%

To evaluate the conduction losses use the following equation:
 $P = 0.42 \times I_{F(AV)} + 0.007 \times I_{F(RMS)}^2$

Figure 2. Conduction losses versus average current

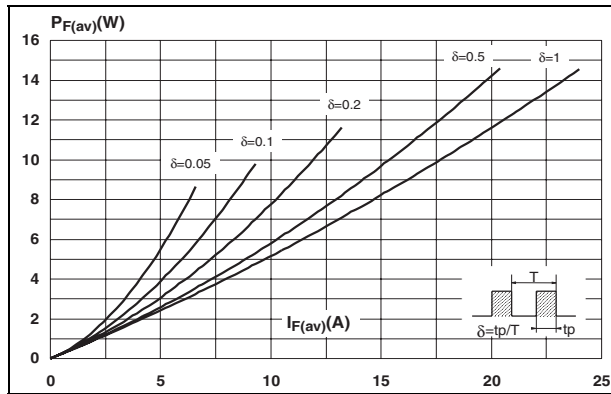

Figure 3. Average forward current versus ambient temperature (delta = 0.5)

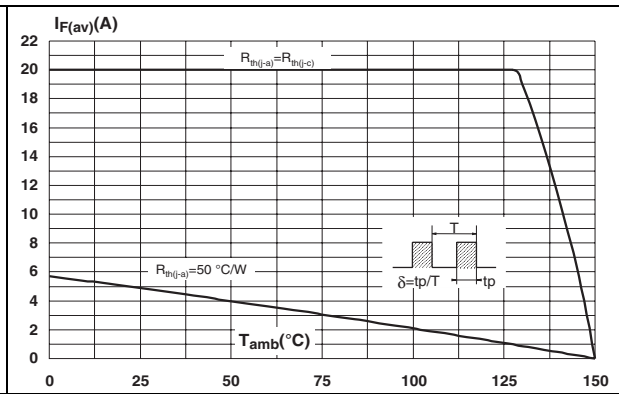

Figure 4. Normalized avalanche power derating versus pulse duration

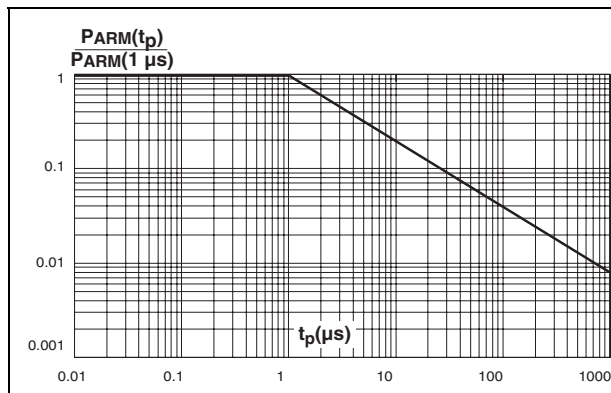

Figure 5. Normalized avalanche power derating versus junction temperature

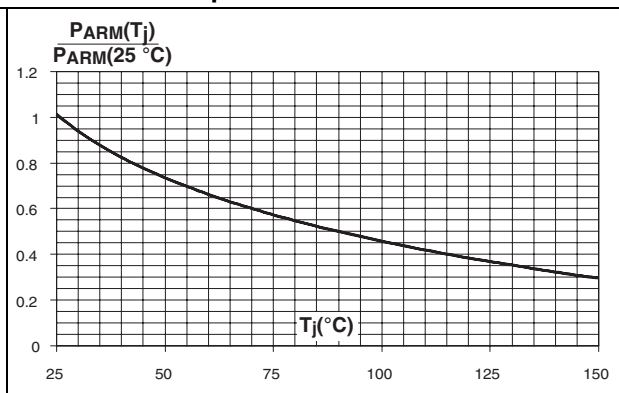

Figure 6. Non repetitive surge peak forward current versus overload duration (maximum values)

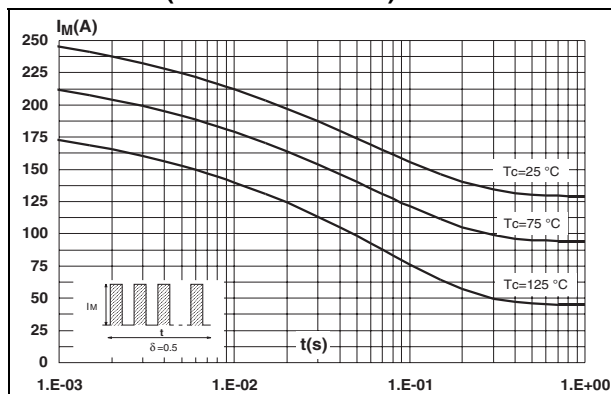

Figure 7. Relative variation of thermal impedance junction to case versus pulse duration

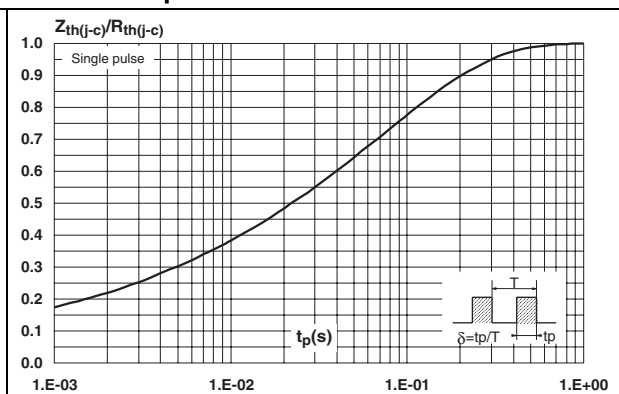

Figure 8. Reverse leakage current versus reverse voltage applied (typical values)

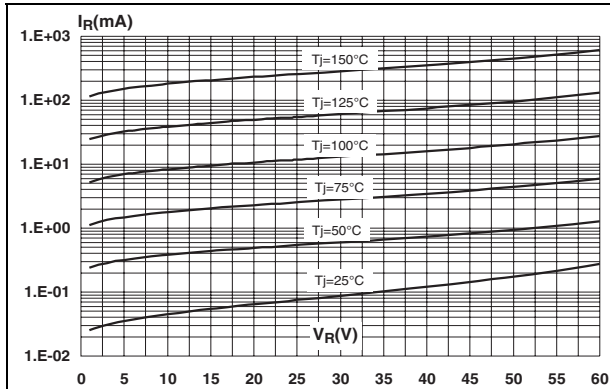

Figure 9. Junction capacitance versus reverse voltage applied (typical values)

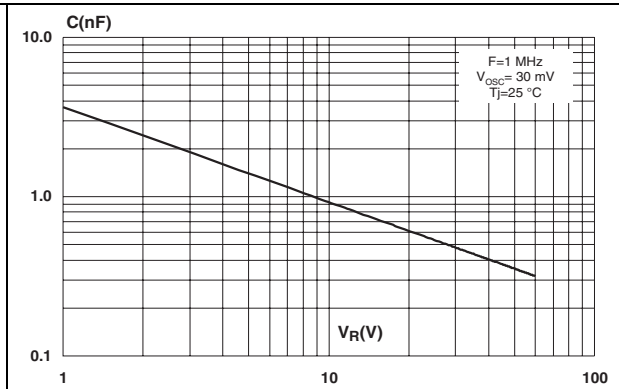

Figure 10. Forward voltage drop versus forward current

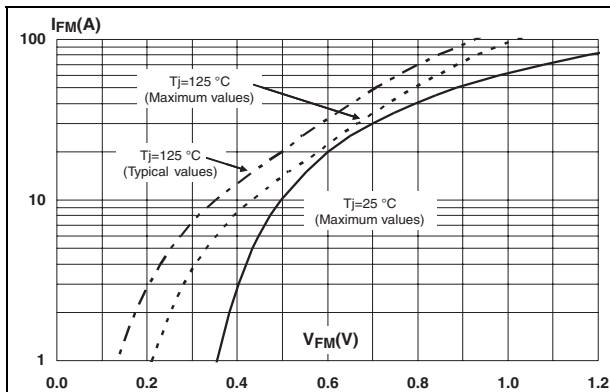

Figure 11. Thermal resistance junction to ambient versus copper surface under tab (STPS41L60CG only)

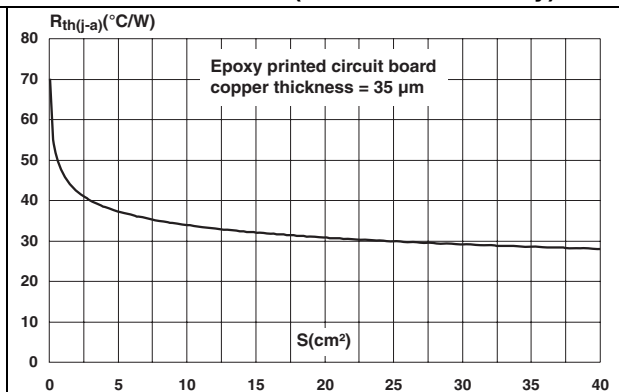
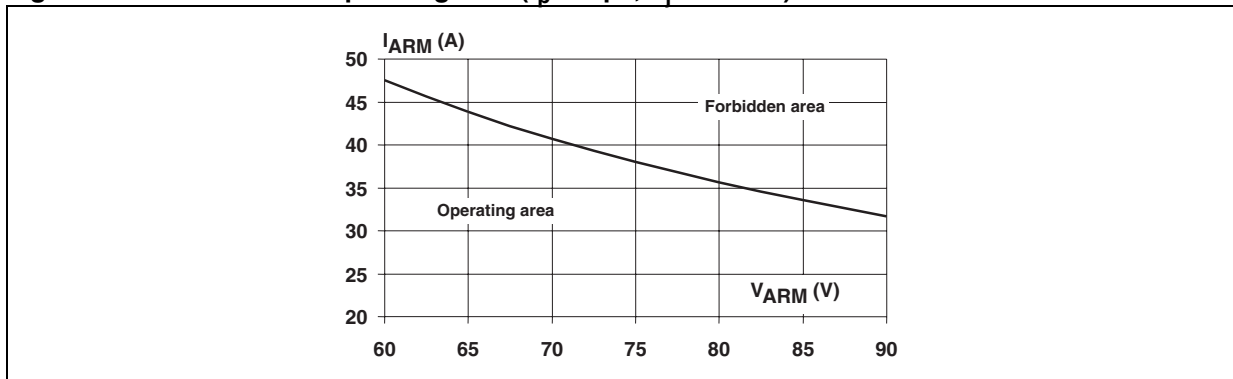

Figure 12. Reverse safe operating area ($t_p < 1 \mu\text{s}$, $T_j > 150^\circ\text{C}$)



2 Package information

- Epoxy meets UL94,V0
- Cooling method: by conduction (C)
- Recommended torque value: 0.4 to 0.6 N·m

In order to meet environmental requirements, ST offers these devices in different grades of ECOPACK[®] packages, depending on their level of environmental compliance. ECOPACK[®] specifications, grade definitions and product status are available at: www.st.com. ECOPACK[®] is an ST trademark.

Figure 13. Package dimensions I²PAK

Ref.	Dimensions			
	Millimeters		Inches	
	Min.	Max.	Min.	Max.
A	4.40	4.60	0.173	0.181
A1	2.49	2.69	0.098	0.106
b	0.70	0.93	0.028	0.037
b1	1.14	1.17	0.044	0.046
b2	1.14	1.17	0.044	0.046
c	0.45	0.60	0.018	0.024
c2	1.23	1.36	0.048	0.054
D	8.95	9.35	0.352	0.368
e	2.40	2.70	0.094	0.106
E	10.0	10.4	0.394	0.409
L	13.1	13.6	0.516	0.535
L1	3.48	3.78	0.137	0.149
L2	1.27	1.40	0.050	0.055

Figure 14. Package dimensions D²PAK

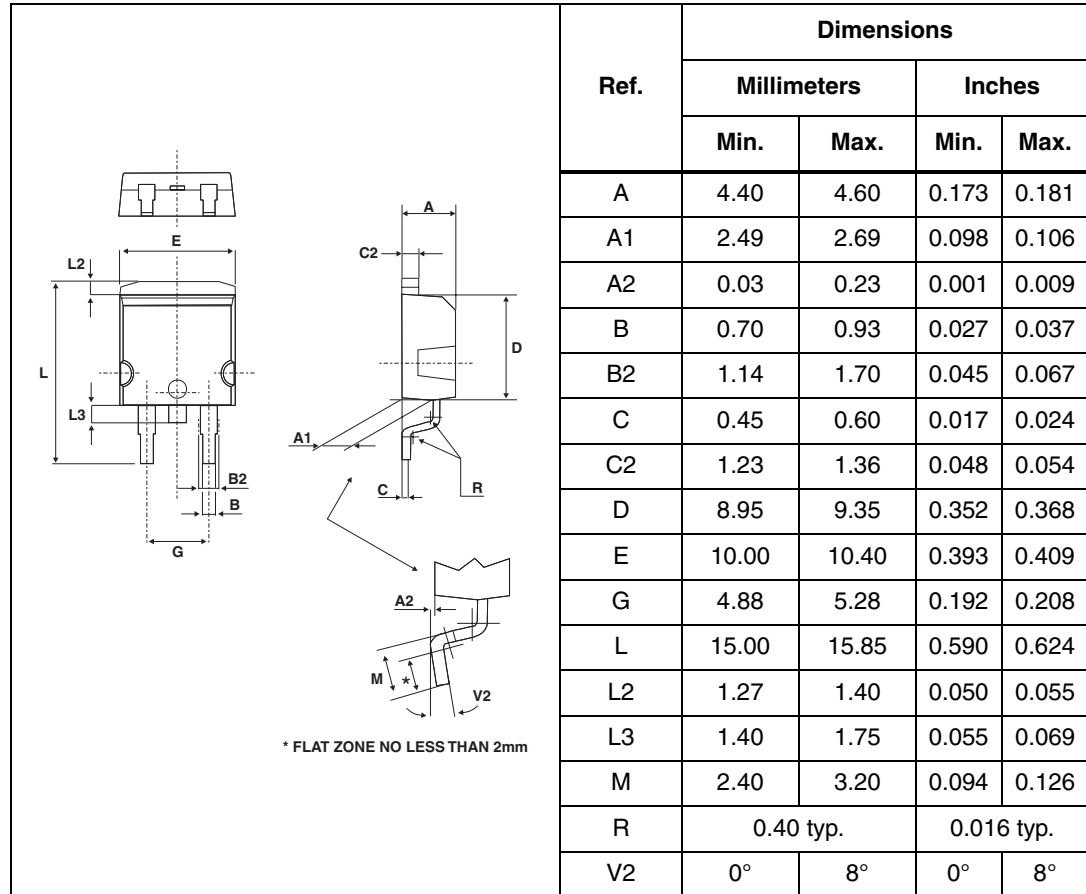

Figure 15. Footprint

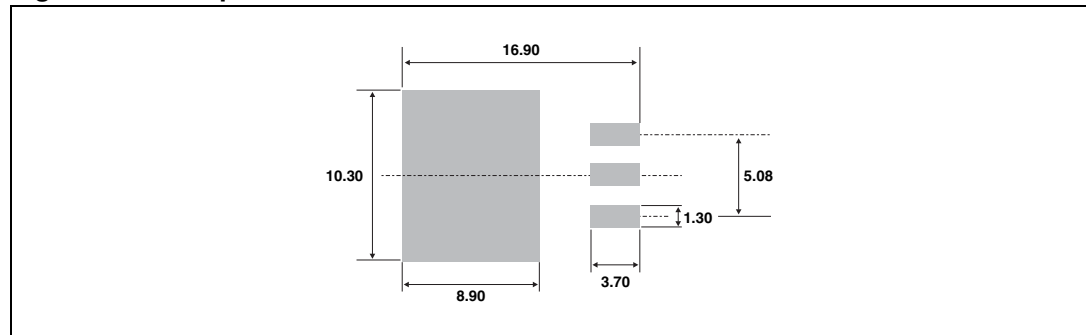
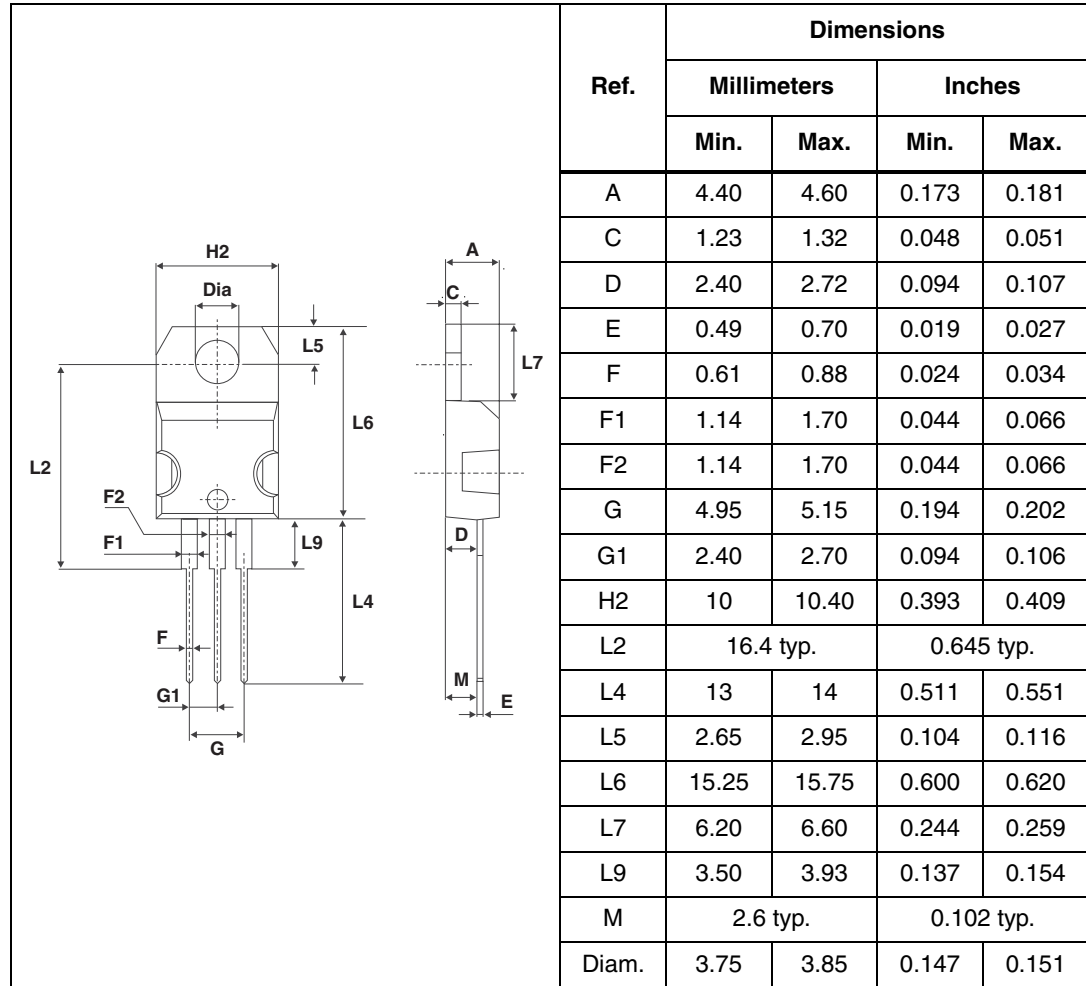

Figure 16. Package dimensions TO-220AB



3 Ordering information

Table 5. Ordering information

Order code	Marking	Package	Weight	Base qty	Delivery mode
STPS41L60CG	STPS41L60CG	D ² PAK	1.48 g	50	Tube
STPS41L60CG-TR	STPS41L60CG	D ² PAK	1.48 g	1000	Tape and reel
STPS41L60CT	STPS41L60CT	TO-220AB	2.20 g	50	Tube
STPS41L60CR	STPS41L60CR	I ² PAK	1.49 g	50	Tube

4 Revision history

Table 6. Document revision history

Date	Revision	Changes
July 2003	3A	Previous issue
10-Jan-2007	4	Reformatted to current standards. Added ECOPACK statement Removed I_{RRM} and dV/dT from the Absolute ratings table on page 1. Updated reverse leakage current values in Table 3 and Figure 7.
28-May-2007	5	Updated figures 1, 2, and 5 to 10.
15-Jul-2011	6	Added electrical diagram on first page. Added parameters V_{ARM} and V_{ASM} to Table 2 . Added Figure 12 .

Please Read Carefully:

Information in this document is provided solely in connection with ST products. STMicroelectronics NV and its subsidiaries ("ST") reserve the right to make changes, corrections, modifications or improvements, to this document, and the products and services described herein at any time, without notice.

All ST products are sold pursuant to ST's terms and conditions of sale.

Purchasers are solely responsible for the choice, selection and use of the ST products and services described herein, and ST assumes no liability whatsoever relating to the choice, selection or use of the ST products and services described herein.

No license, express or implied, by estoppel or otherwise, to any intellectual property rights is granted under this document. If any part of this document refers to any third party products or services it shall not be deemed a license grant by ST for the use of such third party products or services, or any intellectual property contained therein or considered as a warranty covering the use in any manner whatsoever of such third party products or services or any intellectual property contained therein.

UNLESS OTHERWISE SET FORTH IN ST'S TERMS AND CONDITIONS OF SALE ST DISCLAIMS ANY EXPRESS OR IMPLIED WARRANTY WITH RESPECT TO THE USE AND/OR SALE OF ST PRODUCTS INCLUDING WITHOUT LIMITATION IMPLIED WARRANTIES OF MERCHANTABILITY, FITNESS FOR A PARTICULAR PURPOSE (AND THEIR EQUIVALENTS UNDER THE LAWS OF ANY JURISDICTION), OR INFRINGEMENT OF ANY PATENT, COPYRIGHT OR OTHER INTELLECTUAL PROPERTY RIGHT.

UNLESS EXPRESSLY APPROVED IN WRITING BY AN AUTHORIZED ST REPRESENTATIVE, ST PRODUCTS ARE NOT RECOMMENDED, AUTHORIZED OR WARRANTED FOR USE IN MILITARY, AIR CRAFT, SPACE, LIFE SAVING, OR LIFE SUSTAINING APPLICATIONS, NOR IN PRODUCTS OR SYSTEMS WHERE FAILURE OR MALFUNCTION MAY RESULT IN PERSONAL INJURY, DEATH, OR SEVERE PROPERTY OR ENVIRONMENTAL DAMAGE. ST PRODUCTS WHICH ARE NOT SPECIFIED AS "AUTOMOTIVE GRADE" MAY ONLY BE USED IN AUTOMOTIVE APPLICATIONS AT USER'S OWN RISK.

Resale of ST products with provisions different from the statements and/or technical features set forth in this document shall immediately void any warranty granted by ST for the ST product or service described herein and shall not create or extend in any manner whatsoever, any liability of ST.

ST and the ST logo are trademarks or registered trademarks of ST in various countries.

Information in this document supersedes and replaces all information previously supplied.

The ST logo is a registered trademark of STMicroelectronics. All other names are the property of their respective owners.

© 2011 STMicroelectronics - All rights reserved

STMicroelectronics group of companies

Australia - Belgium - Brazil - Canada - China - Czech Republic - Finland - France - Germany - Hong Kong - India - Israel - Italy - Japan - Malaysia - Malta - Morocco - Philippines - Singapore - Spain - Sweden - Switzerland - United Kingdom - United States of America

www.st.com