

MOTOROLA
SEMICONDUCTOR
TECHNICAL DATA

Designer's Data Sheet
Power Field Effect Transistor
N-Channel Enhancement-Mode
Silicon Gate TMOS

These TMOS Power FETs are designed for high voltage, high speed power switching applications such as switching regulators, converters, solenoid and relay drivers.

- Silicon Gate for Fast Switching Speeds — Switching Times Specified at 100°C
- Designer's Data — I_{DSS} , $V_{DS(on)}$, $V_{GS(th)}$ and SOA Specified at Elevated Temperature
- Rugged — SOA is Power Dissipation Limited
- Source-to-Drain Diode Characterized for Use With Inductive Loads



MTH8N55
MTH8N60
MTM8N60

TMOS POWER FETs
8 AMPERES
 $r_{DS(on)} = 0.5 \text{ OHM}$
550 and 600 VOLTS

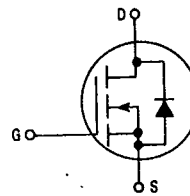

MAXIMUM RATINGS

Rating	Symbol	MTH8N55	MTH8N60 MTM8N60	Unit
Drain-Source Voltage	V_{DSS}	550	600	Vdc
Drain-Gate Voltage ($R_{GS} = 1 \text{ M}\Omega$)	V_{DGR}	550	600	Vdc
Gate-Source Voltage Continuous Non-repetitive ($t_p \leq 50 \mu\text{s}$)	V_{GS} V_{GSM}	± 20 ± 40		Vdc Vpk
Drain Current — Continuous — Pulsed	I_D I_{DM}	8 41		Adc
Total Power Dissipation @ $T_C = 25^\circ\text{C}$ Derate above 25°C	PD	150 1.2		Watts W/°C
Operating and Storage Temperature Range	T_J, T_{stg}	-65 to 150		°C

THERMAL CHARACTERISTICS

Thermal Resistance — Junction to Case — Junction to Ambient	$R_{\theta JC}$ $R_{\theta JA}$	0.83 30		°C/W
Maximum Lead Temperature for Soldering Purposes, 1/8" from case for 5 seconds	T_L	275		°C

ELECTRICAL CHARACTERISTICS ($T_C = 25^\circ\text{C}$ unless otherwise noted)

Characteristic	Symbol	Min	Max	Unit
----------------	--------	-----	-----	------

OFF CHARACTERISTICS

Drain-Source Breakdown Voltage ($V_{GS} = 0, I_D = 0.25 \text{ mA}$) MTH8N55 MTH8N60, MTM8N60	$V_{(BR)DSS}$	550 600	— —	Vdc
Zero Gate Voltage Drain Current ($V_{DS} = \text{Rated } V_{DSS}, V_{GS} = 0$) ($V_{DS} = 0.8 \text{ Rated } V_{DSS}$, $V_{GS} = 0, T_J = 125^\circ\text{C}$)	I_{DSS}	— —	0.2 1	mAdc

(continued)

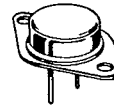

MTM8N60
CASE 1-06
TO-204AA



MTH8N55
MTH8N60
CASE 340-02
TO-218AC

Designer's Data for "Worst Case" Conditions — The Designer's Data Sheet permits the design of most circuits entirely from the information presented. Limit curves — representing boundaries on device characteristics — are given to facilitate "worst case" design.

ELECTRICAL CHARACTERISTICS — continued (T_C = 25°C unless otherwise noted)

Characteristic	Symbol	Min	Max	Unit
----------------	--------	-----	-----	------

OFF CHARACTERISTICS

Gate-Body Leakage Current, Forward (V _{GSF} = 20 Vdc, V _{DS} = 0)	I _{GSSF}	—	100	nAdc
Gate-Body Leakage Current, Reverse (V _{GSR} = 20 Vdc, V _{DS} = 0)	I _{GSSR}	—	100	nAdc

ON CHARACTERISTICS*

Gate Threshold Voltage (V _{DS} = V _{GS} , I _D = 1 mA) T _J = 100°C	V _{GS(th)}	2 1.5	4.5 4	Vdc
Static Drain-Source On-Resistance (V _{GS} = 10 Vdc, I _D = 4 Adc)	r _{DS(on)}	—	0.5	Ohm
Drain-Source On-Voltage (V _{GS} = 10 V) (I _D = 8 Adc) (I _D = 4 Adc, T _J = 100°C)	V _{DS(on)}	— —	5 4	Vdc
Forward Transconductance (V _{DS} = 10 V, I _D = 4 A)	g _{FS}	4	—	mhos

DYNAMIC CHARACTERISTICS

Input Capacitance	(V _{DS} = 25 V, V _{GS} = 0, f = 1 MHz) See Figure 11	C _{iss}	—	2300	pF
Output Capacitance		C _{oss}	—	425	
Reverse Transfer Capacitance		C _{rss}	—	180	

SWITCHING CHARACTERISTICS* (T_J = 100°C)

Turn-On Delay Time	(V _{DD} = 25 V, I _D = 0.5 Rated I _D R _{gen} = 50 ohms) See Figures 13 and 14	t _{d(on)}	—	70	ns
Rise Time		t _r	—	160	
Turn-Off Delay Time		t _{d(off)}	—	430	
Fall Time		t _f	—	200	
Total Gate Charge	(V _{DS} = 0.8 Rated V _{DSS} , I _D = Rated I _D , V _{GS} = 10 V) See Figure 12	Q _g	127 (Typ)	150	nC
Gate-Source Charge		Q _{gs}	62 (Typ)	—	
Gate-Drain Charge		Q _{gd}	65 (Typ)	—	

SOURCE DRAIN DIODE CHARACTERISTICS*

Forward On-Voltage	(I _S = Rated I _D V _{GS} = 0)	V _{SD}	1.2 (Typ)	2	Vdc
Forward Turn-On Time		t _{on}	Limited by stray inductance		
Reverse Recovery Time		t _{rr}	500 (Typ)	—	ns

INTERNAL PACKAGE INDUCTANCE (TO-204)

Internal Drain Inductance (Measured from the contact screw on the header closer to the source pin and the center of the die)	L _d	5 (Typ)	—	nH
Internal Source Inductance (Measured from the source pin, 0.25" from the package to the source bond pad)	L _s	12.5 (Typ)	—	

INTERNAL PACKAGE INDUCTANCE (TO-218)

Internal Drain Inductance (Measured from screw on tab to center of die) (Measured from the drain lead 0.25" from package to center of die)	L _d	4 (Typ) 5 (Typ)	— —	nH
Internal Source Inductance (Measured from the source lead 0.25" from package to center of die)	L _s	10 (Typ)	—	

*Pulse Test: Pulse Width ≤ 300 μs, Duty Cycle ≤ 2%.

TYPICAL ELECTRICAL CHARACTERISTICS

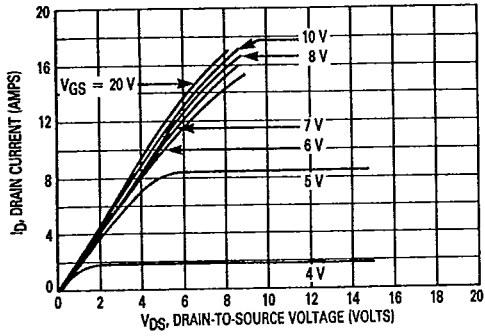

Figure 1. On-Region Characteristics

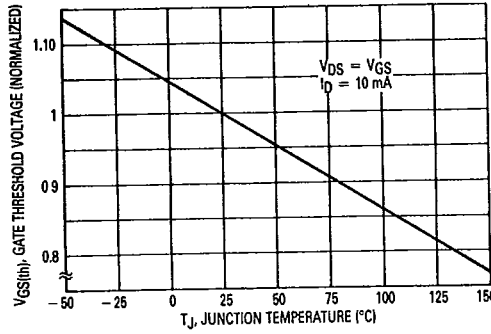

Figure 2. Gate-Threshold Voltage Variation With Temperature

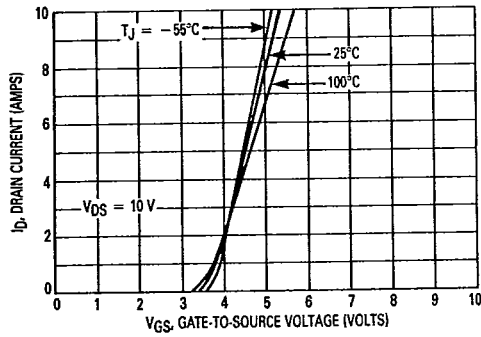

Figure 3. Transfer Characteristics

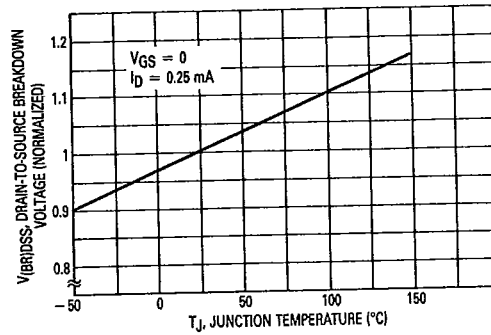

Figure 4. Breakdown Voltage Variation With Temperature

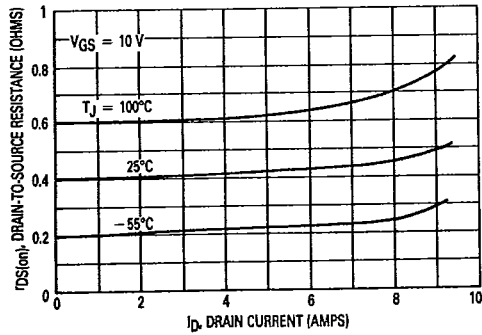

Figure 5. On-Resistance versus Drain Current

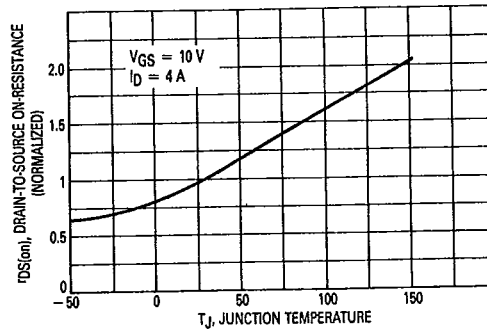

Figure 6. On-Resistance Variation With Temperature

SAFE OPERATING AREA INFORMATION

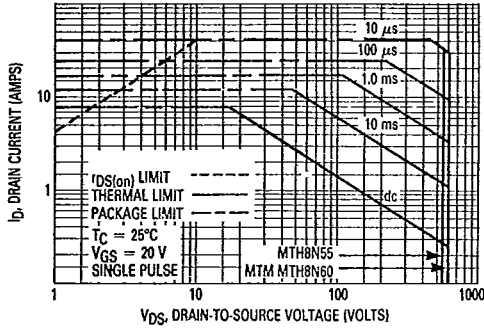

Figure 7. Maximum Rated Forward Biased Safe Operating Area

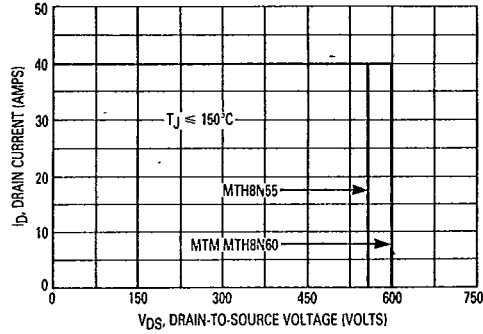

Figure 8. Maximum Rated Switching Safe Operating Area

FORWARD BIASED SAFE OPERATING AREA

The FBSOA curves define the maximum drain-to-source voltage and drain current that a device can safely handle when it is forward biased, or when it is on, or being turned on. Because these curves include the limitations of simultaneous high voltage and high current, up to the rating of the device, they are especially useful to designers of linear systems. The curves are based on a case temperature of 25°C and a maximum junction temperature of 150°C. Limitations for repetitive pulses at various case temperatures can be determined by using the thermal response curves. Motorola Application Note, AN569, "Transient Thermal Resistance-General Data and Its Use" provides detailed instructions.

SWITCHING SAFE OPERATING AREA

The switching safe operating area (SOA) of Figure 8 is the boundary that the load line may traverse without incurring damage to the MOSFET. The fundamental limits are the peak current, I_{DM} and the breakdown voltage, $V_{(BR)DSS}$. The switching SOA shown in Figure 8 is applicable for both turn-on and turn-off of the devices for switching times less than one microsecond.

The power averaged over a complete switching cycle must be less than:

$$\frac{T_J(\text{max}) - T_C}{R_{\theta JC}}$$

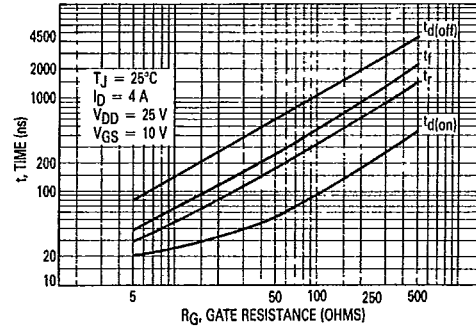

Figure 9. Resistive Switching Time Variation With Gate Resistance

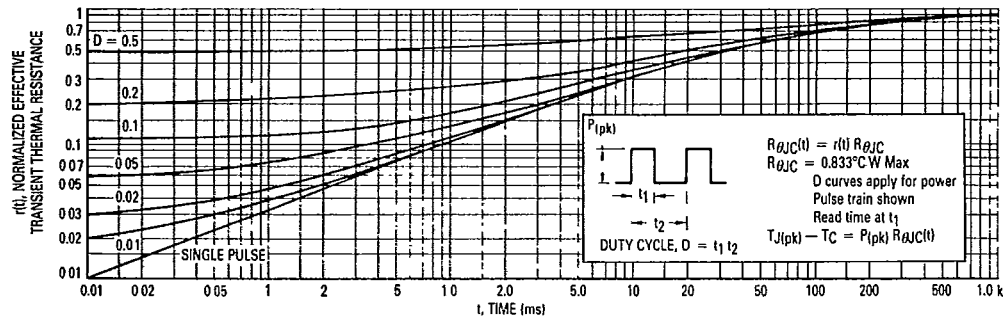

Figure 10. Thermal Response

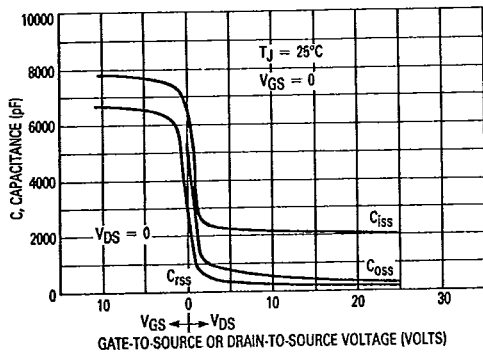

Figure 11. Capacitance Variation

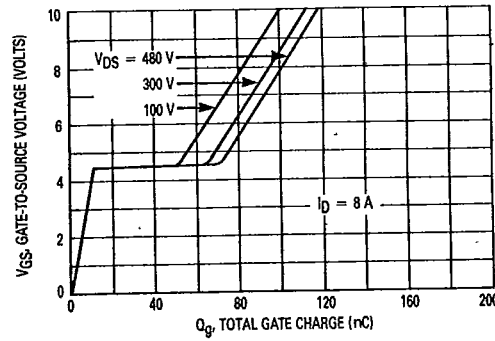

Figure 12. Gate Charge versus Gate-to-Source Voltage

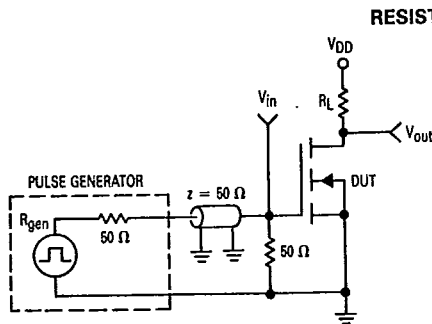

Figure 13. Switching Test Circuit

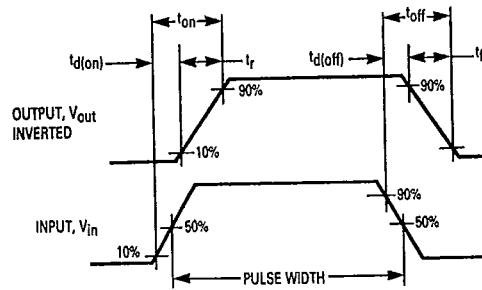

Figure 14. Switching Waveforms

OUTLINE DIMENSIONS

**CASE 1-06
TO-204AA**

DIM	MILLIMETERS		INCHES	
	MIN	MAX	MIN	MAX
A	—	39.37	—	1.550
B	—	21.08	—	0.830
C	5.25	8.25	0.205	0.325
D	0.97	1.09	0.038	0.043
E	1.40	1.77	0.055	0.070
F	30.15 BSC	—	1.187 BSC	—
G	12.82 BSC	—	0.505 BSC	—
H	5.46 BSC	—	0.215 BSC	—
J	16.85 BSC	—	0.665 BSC	—
K	11.18	12.19	0.440	0.480
Q	3.84	4.18	0.151	0.165
R	—	25.67	—	1.050
U	4.83	5.33	0.190	0.210
V	3.84	4.19	0.151	0.165

NOTES:
1. DIMENSIONING AND TOLERANCING PER ANSI Y14.5M, 1982.
2. CONTROLLING DIMENSION: INCH.
3. ALL RULES AND NOTES ASSOCIATED WITH REFERENCED TO-204AA OUTLINE SHALL APPLY.

STYLE 3:
PIN 1. GATE
2. SOURCE
CASE DRAIN

**CASE 340-02
TO-218AC**

DIM	MILLIMETERS		INCHES	
	MIN	MAX	MIN	MAX
A	20.32	21.08	0.800	0.830
B	15.49	15.90	0.610	0.626
C	4.19	5.08	0.165	0.200
D	1.02	1.65	0.040	0.065
E	1.25	1.65	0.053	0.065
G	5.21	5.72	0.205	0.225
H	2.65	2.94	0.104	0.116
J	0.38	0.64	0.015	0.025
K	12.70	15.49	0.500	0.610
L	15.88	16.51	0.625	0.650
N	12.19	12.70	0.480	0.500
Q	4.04	4.22	0.159	0.166

NOTES:
1. DIMENSIONING AND TOLERANCING PER ANSI Y14.5M, 1982.
2. CONTROLLING DIMENSION: INCH.

STYLE 2:
PIN 1. GATE
2. DRAIN
3. SOURCE
4. DRAIN