



CHENMKO ENTERPRISE CO.,LTD

Halogens free devices

SURFACE MOUNT
Dual Digital Silicon Transistor
VOLTAGE 50 Volts CURRENT 30 mAmpere

CHUMD2GP

APPLICATION
 * Switching circuit, Inverter, Interface circuit, Driver circuit.

FEATURE
 * Small surface mounting type. (SC-88/SOT-363)
 * High current gain.
 * Suitable for high packing density.
 * Low collector-emitter saturation.
 * High saturation current capability.
 * Both the CHDTA124E & CHDTC124E in one package.
 * Built in bias resistor(R1=22kΩ, Typ.)

MARKING
 * ED

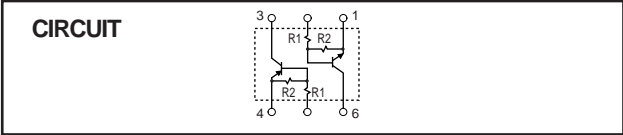
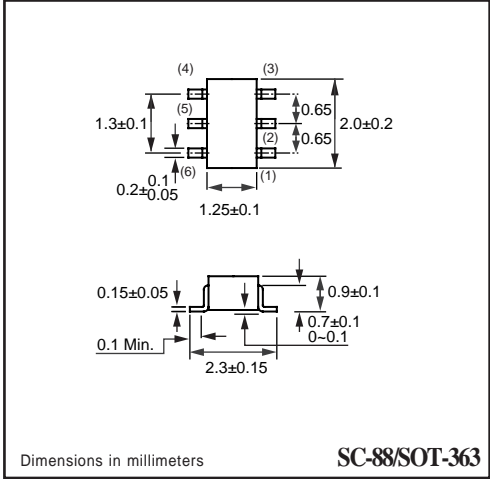
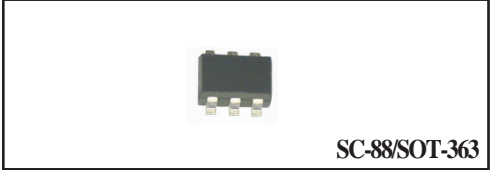

CHDTA124E LIMITING VALUES
 In accordance with the Absolute Maximum Rating System (IEC 60134).

SYMBOL	PARAMETER	CONDITIONS	MIN.	MAX.	UNIT
V _{CC}	Supply voltage		-	-50	V
V _{IN}	Input voltage		-40	+10	V
I _o	DC Output current		-	-30	mA
I _{C(Max.)}			-	-100	
P _{TOT}	Total power dissipation	T _{amb} ≤ 25 °C, Note 1	-	150	mW
T _{STG}	Storage temperature		-55	+150	°C
T _J	Junction temperature		-	150	°C
R _{θJ-S}	Thermal resistance	junction - soldering point	-	140	°C/W

Note
 Transistor mounted on an FR4 printed-circuit board.

CHDTC124E LIMITING VALUES

In accordance with the Absolute Maximum Rating System (IEC 60134).

SYMBOL	PARAMETER	CONDITIONS	MIN.	MAX.	UNIT
V _{CC}	Supply voltage		–	50	V
V _{IN}	Input voltage		-10	+40	V
I _O	DC Output current		–	30	mA
I _{C(Max.)}			–	100	
P _{TOT}	Total power dissipation	T _{amb} ≤ 25 °C, Note 1	–	150	mW
T _{STG}	Storage temperature		-55	+150	°C
T _J	Junction temperature		–	150	°C
R _{θJ-S}	Thermal resistance	junction - soldering point	–	140	°C/W

Note

Transistor mounted on an FR4 printed-circuit board.

CHDTA124E CHARACTERISTICS

T_{amb} = 25 °C unless otherwise specified.

SYMBOL	PARAMETER	CONDITIONS	MIN.	TYP.	MAX.	UNIT
V _{I(off)}	Input off voltage	I _O =-100uA; V _{CE} =-5.0V	-0.5	–	–	V
V _{I(on)}	Input on voltage	I _O =-5mA; V _O =-0.2V	–	–	-3.0	V
V _{O(on)}	Output voltage	I _O =-10mA; I _I =-0.5mA	–	-0.1	-0.3	V
I _I	Input current	V _I =-5V	–	–	-0.36	mA
I _{C(off)}	Output current	V _I =0V; V _{CC} =-50V	–	–	-0.5	uA
h _{FE}	DC current gain	I _O =-5mA; V _O =-5.0V	56	–	–	
R ₁	Input resistor		15.4	22.0	28.6	KΩ
R _{2/R1}	Resistor ratio		0.8	1.0	1.2	
f _T	Transition frequency	I _C =-5mA, V _{CE} =-10.0V f=100MHz	–	250	–	MHz

Note

Pulse test: t_p≤300uS; δ≤0.02.

CHDTC124E CHARACTERISTICS

T_{amb} = 25 °C unless otherwise specified.

SYMBOL	PARAMETER	CONDITIONS	MIN.	TYP.	MAX.	UNIT
V _{I(off)}	Input off voltage	I _O =100uA; V _{CC} =5.0V	0.5	–	–	V
V _{I(on)}	Input on voltage	I _O =5mA; V _O =0.2V	–	–	3.0	V
V _{O(on)}	Output voltage	I _O =10mA; I _I =0.5mA	–	0.1	0.3	V
I _I	Input current	V _I =5V	–	–	0.36	mA
I _{C(off)}	Output current	V _I =0V; V _{CC} =50V	–	–	0.5	uA
h _{FE}	DC current gain	I _O =5mA; V _O =5.0V	56	–	–	
R ₁	Input resistor		15.4	22	28.6	KΩ
R _{2/R1}	Resistor ratio		0.8	1.0	1.2	
f _T	Transition frequency	I _C =5mA, V _{CE} =10.0V f=100MHz	–	250	–	MHz

Note

Pulse test: t_p≤300uS; δ≤0.02.

RATING CHARACTERISTIC CURVES (CHUMD2GP)

CHDTA124E Typical Electrical Characteristics

Fig.1 Input voltage vs. output current (ON characteristics)

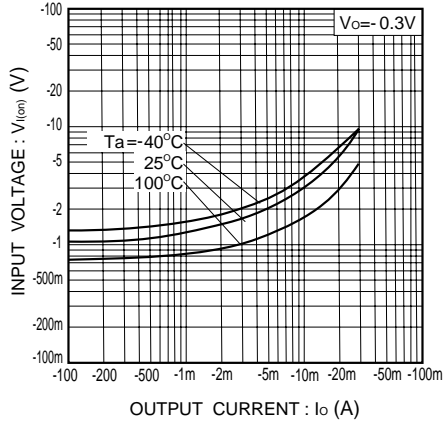

Fig.2 Output current vs. input voltage (OFF characteristics)

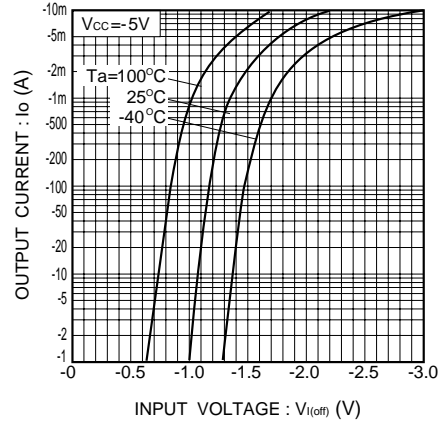

Fig.3 DC current gain vs. output current

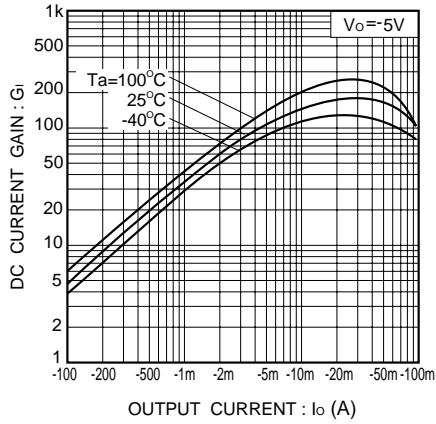
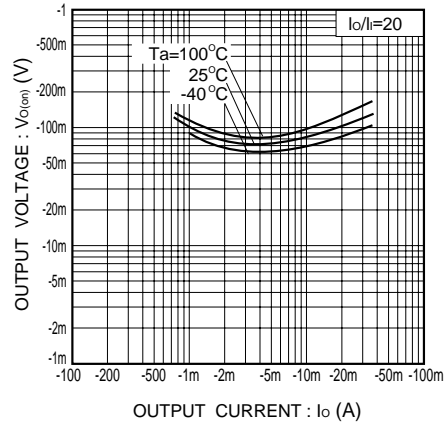

Fig.4 Output voltage vs. output current



RATING CHARACTERISTIC CURVES (CHUMD2GP)

CHDTC124E Typical Electrical Characteristics

Fig.1 Input voltage vs. output current (ON characteristics)

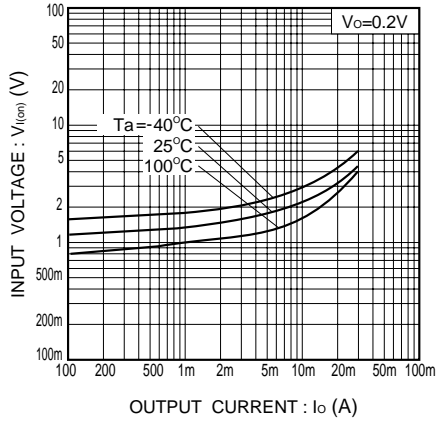

Fig.2 Output current vs. input voltage (OFF characteristics)

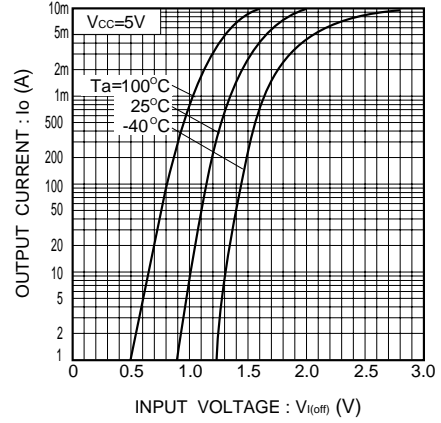

Fig.3 DC current gain vs. output current

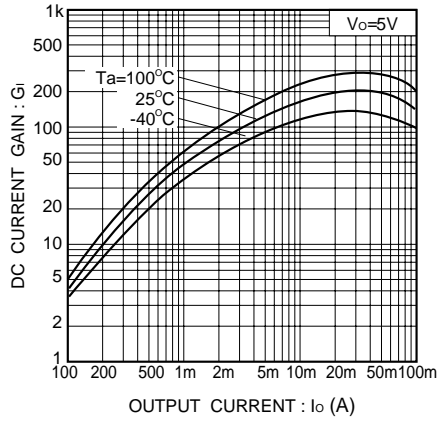

Fig.4 Output voltage vs. output current

