



**CHENMKO ENTERPRISE CO.,LTD**

*Halogens free devices*

**SURFACE MOUNT**  
**Dual Digital Silicon Transistor**  
**VOLTAGE 50 Volts CURRENT 70 mAmpere**

**CHIMD9GP**

**APPLICATION**  
 \* Switching circuit, Inverter, Interface circuit, Driver circuit.

**FEATURE**  
 \* Small surface mounting type. (SC-74/SOT-457)  
 \* High current gain.  
 \* Suitable for high packing density.  
 \* Low collector-emitter saturation.  
 \* High saturation current capability.  
 \* Both the CHDTA114Y & CHDTC114Y in one package.  
 \* Built in bias resistor(R1=10kΩ, Typ. )

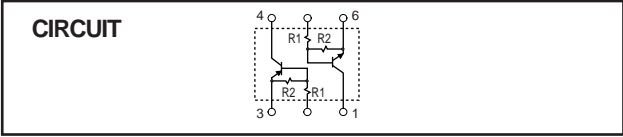
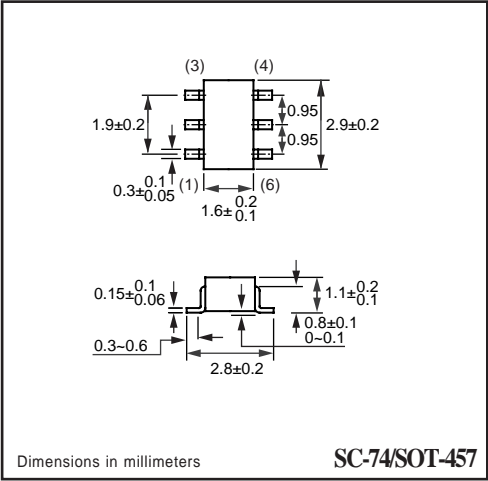
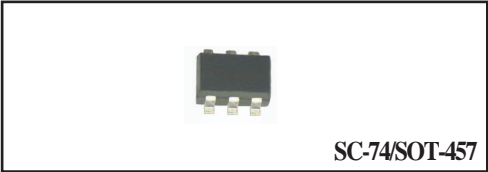

**CHDTA114Y LIMITING VALUES**

In accordance with the Absolute Maximum Rating System (IEC 60134).

SYMBOL	PARAMETER	CONDITIONS	MIN.	MAX.	UNIT
V <sub>CC</sub>	Supply voltage		-	-50	V
V <sub>IN</sub>	Input voltage		-40	+6	V
I <sub>O</sub>	DC Output current		-	-70	mA
I <sub>C(Max.)</sub>			-	-100	
P <sub>TOT</sub>	Total power dissipation	T <sub>amb</sub> ≤ 25 °C, Note 1	-	300	mW
T <sub>STG</sub>	Storage temperature		-55	+150	°C

**Note**

Transistor mounted on an FR4 printed-circuit board.

**CHDTC114Y LIMITING VALUES**

In accordance with the Absolute Maximum Rating System (IEC 60134).

SYMBOL	PARAMETER	CONDITIONS	MIN.	MAX.	UNIT
V <sub>CC</sub>	Supply voltage		–	50	V
V <sub>IN</sub>	Input voltage		-6	+40	V
I <sub>O</sub>	DC Output current		–	70	mA
I <sub>C(Max.)</sub>			–	100	
P <sub>TOT</sub>	Total power dissipation	T <sub>amb</sub> ≤ 25 °C, Note 1	–	150	mW
T <sub>STG</sub>	Storage temperature		-55	+150	°C

**Note**

Transistor mounted on an FR4 printed-circuit board.

**CHDTA114Y CHARACTERISTICS**

T<sub>amb</sub> = 25 °C unless otherwise specified.

SYMBOL	PARAMETER	CONDITIONS	MIN.	TYP.	MAX.	UNIT
V <sub>I(off)</sub>	Input off voltage	I <sub>O</sub> =-100mA; V <sub>CC</sub> =-5.0V	-0.3	–	–	V
V <sub>I(on)</sub>	Input on voltage	I <sub>O</sub> =-1.0mA; V <sub>O</sub> =-0.3V	–	–	-1.4	V
V <sub>O(on)</sub>	Output voltage	I <sub>O</sub> =-5mA; I <sub>I</sub> =-0.25mA	–	-0.1	-0.3	V
I <sub>I</sub>	Input current	V <sub>I</sub> =-5.0V	–	–	-0.88	mA
I <sub>C(off)</sub>	Output current	V <sub>I</sub> =0V; V <sub>CC</sub> =-50V	–	–	-0.5	mA
h <sub>FE</sub>	DC current gain	I <sub>O</sub> =-5.0mA; V <sub>O</sub> =-5.0V	68	–	–	
R <sub>1</sub>	Input resistor		7.0	10.0	13.0	KΩ
R <sub>2/R<sub>1</sub></sub>	Resistor ratio		3.7	4.7	5.7	

**Note**

Pulse test: t<sub>p</sub>≤300uS; δ≤0.02.

**CHDTC114Y CHARACTERISTICS**

T<sub>amb</sub> = 25 °C unless otherwise specified.

SYMBOL	PARAMETER	CONDITIONS	MIN.	TYP.	MAX.	UNIT
V <sub>I(off)</sub>	Input off voltage	I <sub>O</sub> =100mA; V <sub>CC</sub> =5.0V	0.3	–	–	V
V <sub>I(on)</sub>	Input on voltage	I <sub>O</sub> =1mA; V <sub>O</sub> =0.3V	–	–	1.4	V
V <sub>O(on)</sub>	Output voltage	I <sub>O</sub> =5mA; I <sub>I</sub> =0.25mA	–	0.1	0.3	V
I <sub>I</sub>	Input current	V <sub>I</sub> =5V	–	–	0.88	mA
I <sub>C(off)</sub>	Output current	V <sub>I</sub> =0V; V <sub>CC</sub> =50V	–	–	0.5	mA
h <sub>FE</sub>	DC current gain	I <sub>O</sub> =5mA; V <sub>O</sub> =5.0V	68	–	–	
R <sub>1</sub>	Input resistor		7.0	10	13	KΩ
R <sub>2/R<sub>1</sub></sub>	Resistor ratio		3.7	4.7	5.7	

**Note**

Pulse test: t<sub>p</sub>≤300uS; δ≤0.02.

## RATING CHARACTERISTIC CURVES ( CHIMD9GP )

### CHDTA114Y Typical Electrical Characteristics

Fig.1 Input voltage vs. output current (ON characteristics)

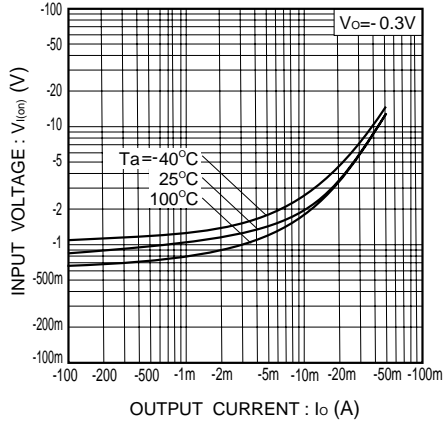

Fig.2 Output current vs. input voltage (OFF characteristics)

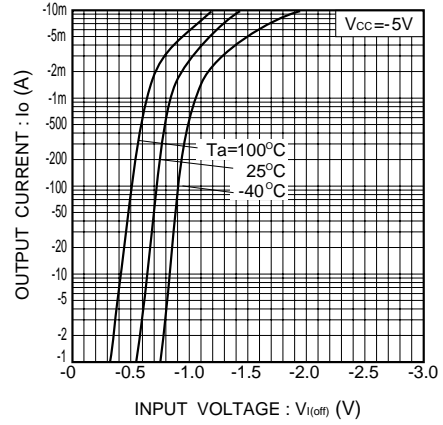

Fig.3 DC current gain vs. output current

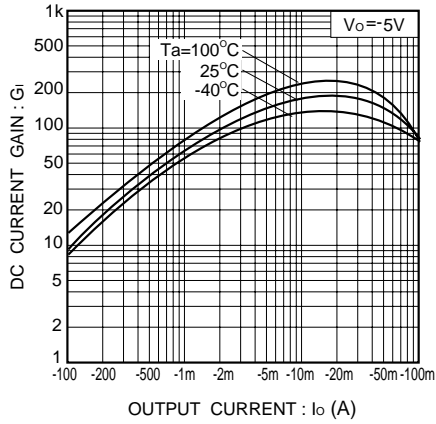
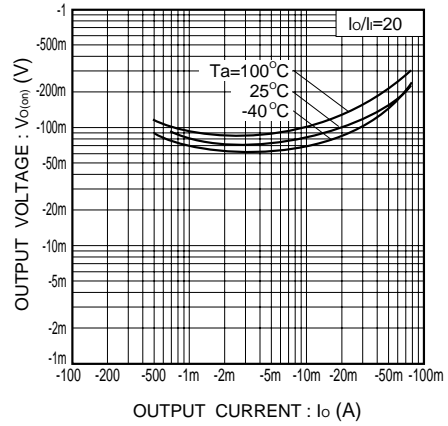

Fig.4 Output voltage vs. output current



## RATING CHARACTERISTIC CURVES ( CHIMD9GP )

### CHDTC114Y Typical Electrical Characteristics

Fig.1 Input voltage vs. output current (ON characteristics)

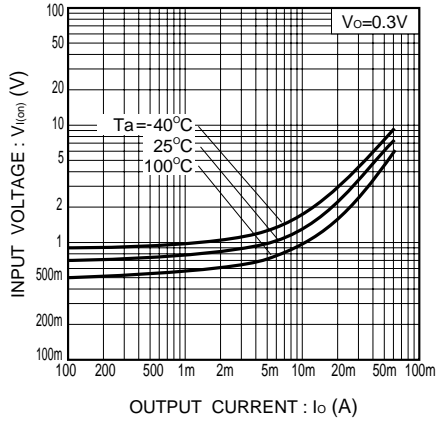

Fig.2 Output current vs. input voltage (OFF characteristics)

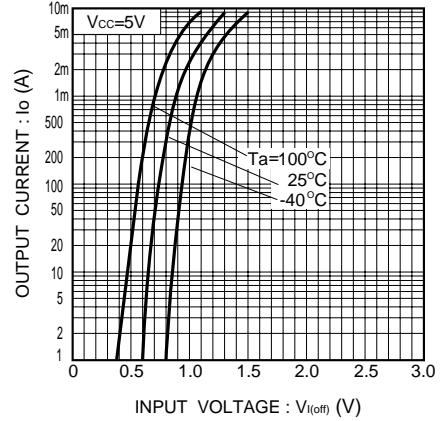

Fig.3 DC current gain vs. output current

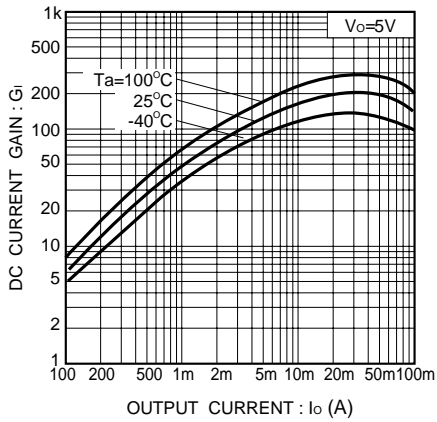

Fig.4 Output voltage vs. output current

