



CHENMKO ENTERPRISE CO.,LTD

Halogens free devices

SURFACE MOUNT
PNP Multi-Chip General Purpose Amplifier
 VOLTAGE 45 Volts CURRENT 0.1 Ampere

CHT857BWGP

APPLICATION

- * AF input stages and driver applicationon equipment.
- * Other general purpose applications.

FEATURE

- * Surface mount package. (SC-70/SOT-323)
- * High current gain.
- * Suitable for high packing density.
- * Low collector-emitter saturation.
- * High saturation current capability.

MARKING

- * HFE(Q):RT
- * HFE(R):RU
- * HFE(S):RV

CIRCUIT

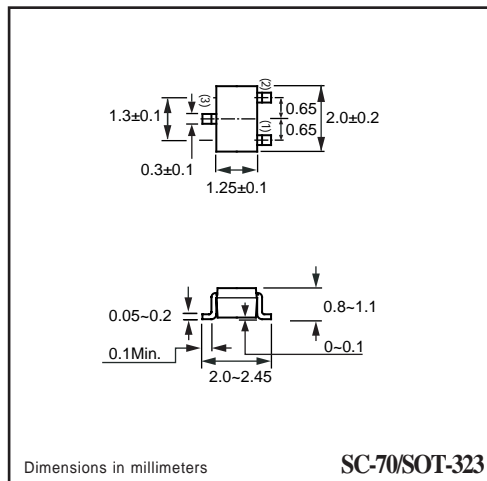
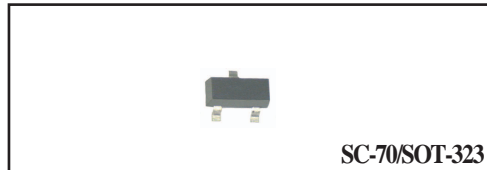
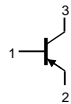

LIMITING VALUES

In accordance with the Absolute Maximum Rating System (IEC 60134).

SYMBOL	PARAMETER	CONDITIONS		UNIT
V _{CB0}	collector-base voltage	open emitter	-50	V
V _{CEO}	collector-emitter voltage	open base	-45	V
V _{EBO}	emitter-base voltage	open collector	-5	V
I _C	collector current (DC)		-0.1	A
P _C	Collector power dissipation		200	mW
T _{stg}	storage temperature		-55~+150	°C
T _j	junction temperature		+150	°C

Note

1. Transistor mounted on an FR4 printed-circuit board.

RATING CHARACTERISTIC (CHT857BWGP)

THERMAL CHARACTERISTICS CHARACTERISTICS

$T_{amb} = 25\text{ }^{\circ}\text{C}$ unless otherwise specified.

SYMBOL	PARAMETER	CONDITIONS	MIN.	Typ.	MAX.	UNIT
I_{CBO}	collector cut-off current	$I_E = 0; V_{CB} = -30\text{ V}$	-	-	-15	nA
		$I_C = 0; V_{CB} = -30\text{ V}; T_A = 150\text{ }^{\circ}\text{C}$	-	-	-5	μA
BV_{CBO}	collector-base breakdown voltage	$I_C = -10\text{ }\mu\text{A}$	-50	-	-	V
BV_{CEO}	collector-emitter breakdown voltage	$I_C = -10\text{ mA}$	-45	-	-	V
BV_{EBO}	emitter-base breakdown voltage	$I_E = -1\text{ }\mu\text{A}$	-5	-	-	V
h_{FE}	DC current transfer ratio	$V_{CE}/I_C = -5\text{ V}/-2\text{ mA}$	-125	-	-800	
V_{CEsat}	collector-emitter saturation voltage	$I_C = -10\text{ mA}; I_B = -0.5\text{ mA}$	-	-	-300	mV
		$I_C = -100\text{ mA}; I_B = -5\text{ mA}$	-	-	-650	mV
V_{BEsat}	base-emitter saturation voltage	$I_C = -10\text{ mA}; I_B = -0.5\text{ mA}$	-	-700	-	mV
C_{ib}	emitter input capacitance	$I_C = 0; V_{CB} = -0.5\text{ V}; f = 1\text{ MHz}$	-	8	-	pF
C_{ob}	collector output capacitance	$I_E = 0; V_{CB} = -10\text{ V}; f = 1\text{ MHz}$	-	3	-	pF
f_T	transition frequency	$I_E = -20\text{ mA}; V_{CE} = 5\text{ V}; f = 100\text{ MHz}$	100	-	-	MHz

Note

1. Pulse test: $t_p \leq 300\text{ }\mu\text{s}; \delta \leq 0.02$.
2. h_{FE} : Classification Q: 125 to 250, R: 220 to 475, S: 420 to 800

RATING CHARACTERISTIC CURVES (CHT857BWGP)

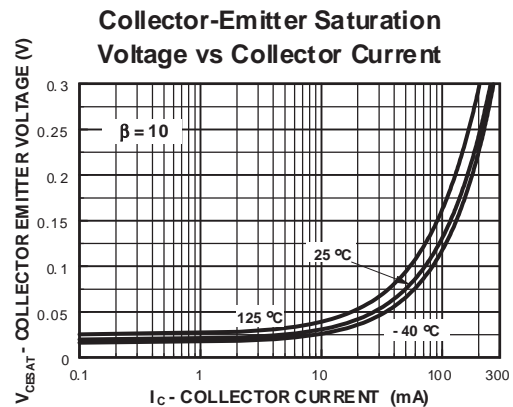
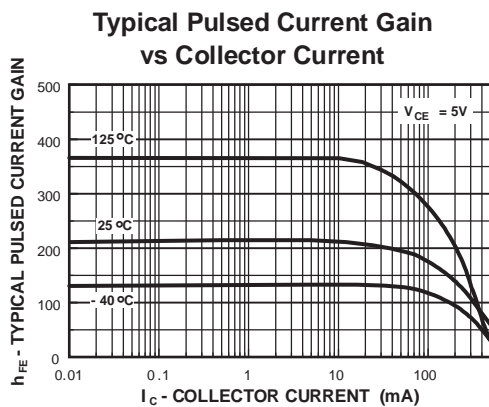

RATING CHARACTERISTIC CURVES (CHT857BWGP)

Base-Emitter Saturation Voltage vs Collector Current

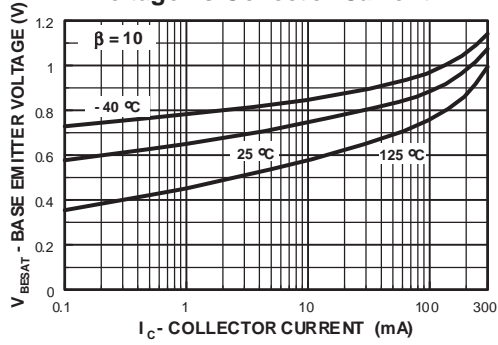

Base Emitter ON Voltage vs Collector Current

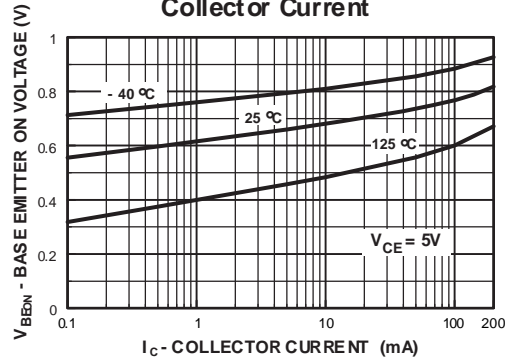

Collector-Cutoff Current vs Ambient Temperature

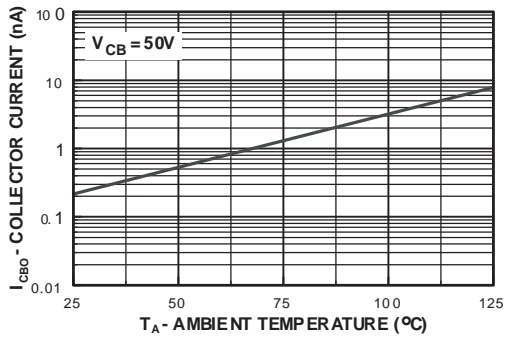

Collector-Emitter Breakdown Voltage with Resistance Between Emitter-Base

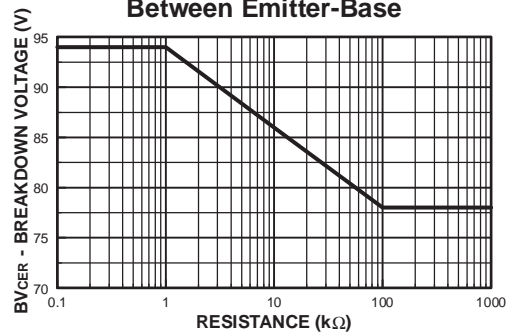

Collector Saturation Region

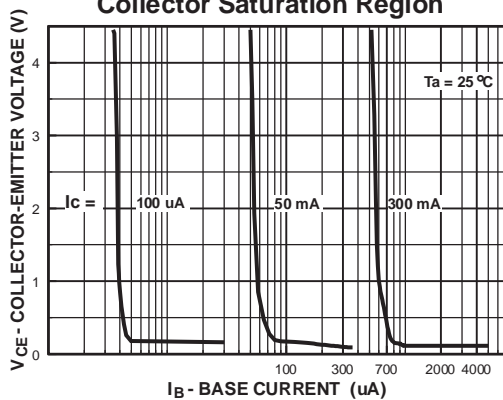

Input and Output Capacitance vs Reverse Voltage

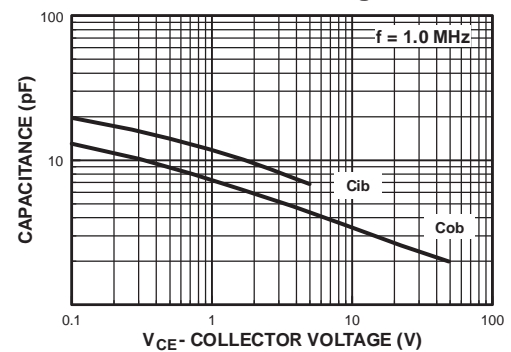

RATING CHARACTERISTIC CURVES (CHT857BWGP)

Gain Bandwidth Product vs Collector Current

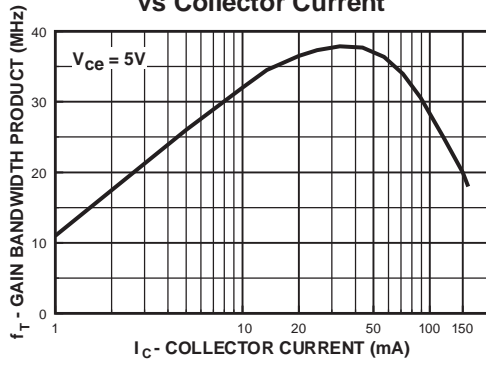

Switching Times vs Collector Current

