

# VHF/UHF Transistors

- Pb-Free Package is Available.
- S- Prefix for Automotive and Other Applications Requiring Unique Site and Control Change Requirements; AEC-Q101 Qualified and PPAP Capable.

## Ordering Information

Device	Marking	Shipping
LSBTH10T1G S-LSBTH10T1G	H8A	3000/Tape&Reel
LSBTH10T3G S-LSBTH10T3G	H8A	10000/Tape&Reel

## MAXIMUM RATINGS

Rating	Symbol	Value	Unit
Collector–Emitter Voltage	$V_{CEO}$	25	Vdc
Collector–Base Voltage	$V_{CBO}$	30	Vdc
Emitter–Base Voltage	$V_{EBO}$	3.0	Vdc

## THERMAL CHARACTERISTICS

Characteristic	Symbol	Max	Unit
Total Device Dissipation FR– 5 Board, (1) $T_A = 25^\circ\text{C}$	$P_D$	225	mW
Derate above $25^\circ\text{C}$		1.8	mW/ $^\circ\text{C}$
Thermal Resistance, Junction to Ambient	$R_{\theta JA}$	556	$^\circ\text{C}/\text{W}$
Total Device Dissipation Alumina Substrate, (2) $T_A = 25^\circ\text{C}$	$P_D$	300	mW
Derate above $25^\circ\text{C}$		2.4	mW/ $^\circ\text{C}$
Thermal Resistance, Junction to Ambient	$R_{\theta JA}$	417	$^\circ\text{C}/\text{W}$
Junction and Storage Temperature	$T_J, T_{stg}$	-55 to +150	$^\circ\text{C}$

## DEVICE MARKING

(S-)LSBTH10T1G = M6

## ELECTRICAL CHARACTERISTICS ( $T_A = 25^\circ\text{C}$ unless otherwise noted.)

Characteristic	Symbol	Min	Typ	Max	Unit
----------------	--------	-----	-----	-----	------

## OFF CHARACTERISTICS

Collector–Emitter Breakdown Voltage ( $I_C = 1.0 \text{ mAdc}, I_E = 0$ )	$V_{(BR)CEO}$	25	—	—	Vdc
Collector–Base Breakdown Voltage ( $I_C = 100 \mu\text{Adc}, I_E = 0$ )	$V_{(BR)CBO}$	30	—	—	Vdc
Emitter–Base Breakdown Voltage ( $I_E = 10 \mu\text{Adc}, I_C = 0$ )	$V_{(BR)EBO}$	3.0	—	—	Vdc
Collector Cutoff Current ( $V_{CB} = 25\text{Vdc}, I_E = 0$ )	$I_{CBO}$	—	—	100	nAdc
Emitter Cutoff Current ( $V_{EB} = 2.0\text{Vdc}, I_C = 0$ )	$I_{EBO}$	—	—	100	nAdc

1. FR–5 =  $1.0 \times 0.75 \times 0.062$  in.

2. Alumina =  $0.4 \times 0.3 \times 0.024$  in. 99.5% alumina.

**LSBTH10T1G**  
**S-LSBTH10T1G**

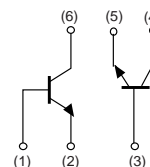
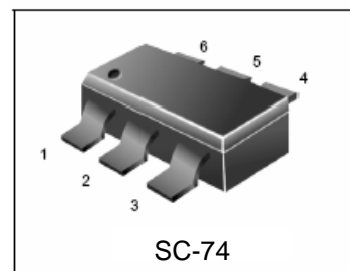

## LSBTH10T1G , S-LSBTH10T1G

**ELECTRICAL CHARACTERISTICS** ( $T_A = 25^\circ\text{C}$  unless otherwise noted) (Continued)

Characteristic	Symbol	Min	Typ	Max	Unit
----------------	--------	-----	-----	-----	------

**DC CHARACTERISTICS**

DC Current Gain ( $I_C = 4.0 \text{ mA}$ , $V_{CE} = 10 \text{ Vdc}$ )	$h_{FE}$	60	—	—	—
Collector–Emitter Saturation Voltage ( $I_C = 4.0 \text{ mA}$ , $I_B = 0.4 \text{ mA}$ )	$V_{CE(sat)}$	—	—	0.5	Vdc
Base–Emitter On Voltage ( $I_C = 4.0 \text{ mA}$ , $V_{CE} = 10 \text{ Vdc}$ )	$V_{BE}$	—	—	0.95	Vdc

**SMALL–SIGNAL CHARACTERISTICS**

Current Gain–Bandwidth Product ( $V_{CE} = 10 \text{ Vdc}$ , $I_C = 4.0 \text{ mA}$ , $f = 100 \text{ MHz}$ )	$f_T$	650	—	—	MHz
Collector –Base Capacitance ( $V_{CB} = 10 \text{ Vdc}$ , $I_E = 0$ , $f = 1.0 \text{ MHz}$ )	$C_{cb}$	—	—	0.7	pF
Collector –Base Feedback Capacitance ( $V_{CB} = 10 \text{ Vdc}$ , $I_E = 0$ , $f = 1.0 \text{ MHz}$ )	$C_{fb}$	—	—	0.65	pF
Collector Base Time Constant ( $I_C = 4.0 \text{ mA}$ , $V_{CB} = 10 \text{ Vdc}$ , $f = 31.8 \text{ MHz}$ )	$r_b' C_C$	—	—	9.0	ps

# LSBTH10T1G , S-LSBTH10T1G

## TYPICAL CHARACTERISTICS

### COMMON-BASE y PARAMETERS versus FREQUENCY

( $V_{CB} = 10 \text{ Vdc}$ ,  $I_C = 4.0 \text{ mA dc}$ ,  $T_A = 25^\circ\text{C}$ )

#### $y_{ib}$ , INPUT ADMITTANCE

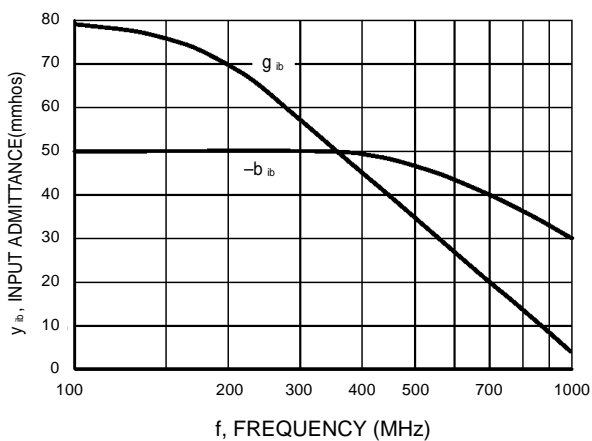

Figure 1. Rectangular Form

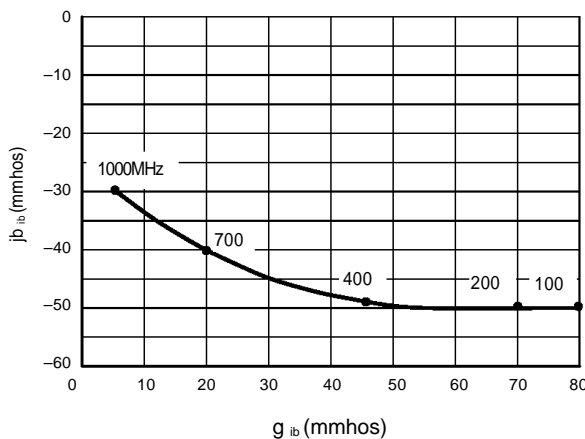

Figure 2. Polar Form

#### $y_{fb}$ , FORWARD TRANSFER ADMITTANCE

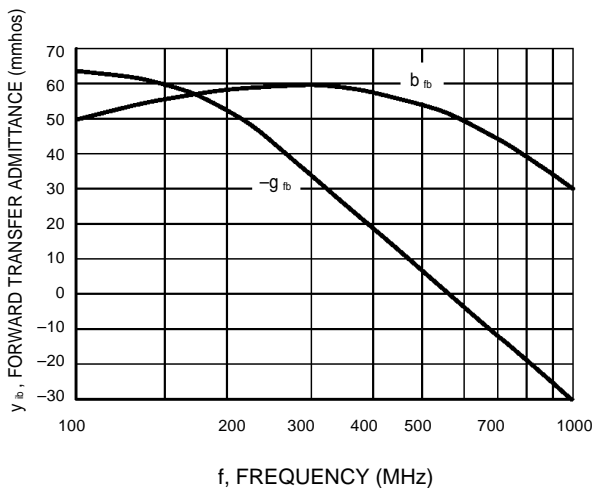

Figure 3. Rectangular Form

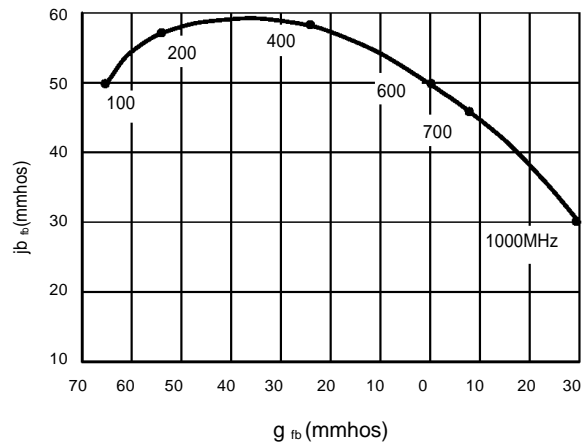

Figure 4. Polar Form

# LSBTH10T1G , S-LSBTH10T1G

## TYPICAL CHARACTERISTICS

### COMMON-BASE $y$ PARAMETERS versus FREQUENCY

( $V_{CB} = 10$  Vdc,  $I_C = 4.0$  mAdc,  $T_A = 25^\circ\text{C}$ )

$y_{rb}$ , REVERSE TRANSFER ADMITTANCE

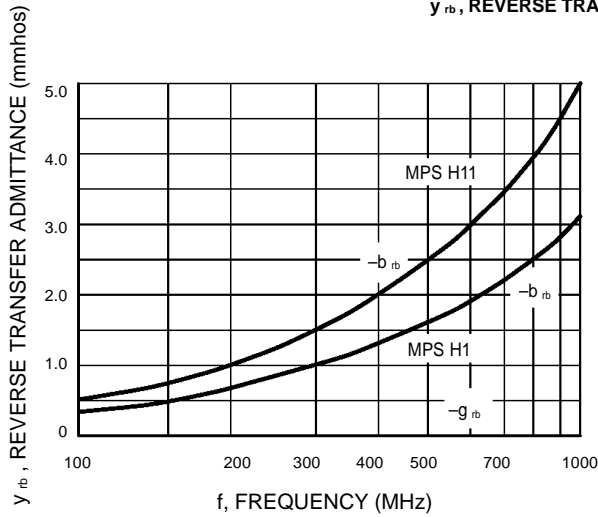

Figure 5. Rectangular Form

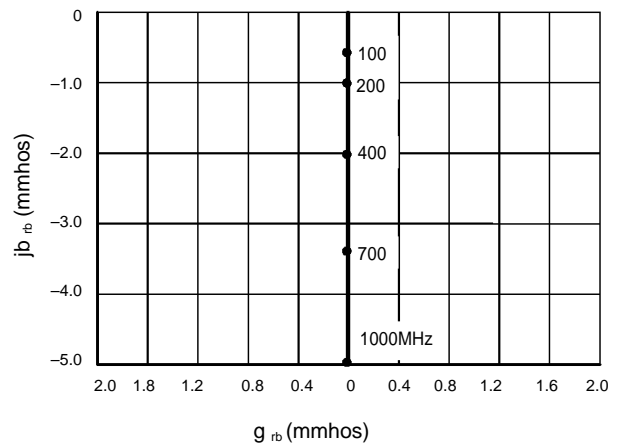

Figure 6. Polar Form

### $y_{ob}$ , OUTPUT ADMITTANCE

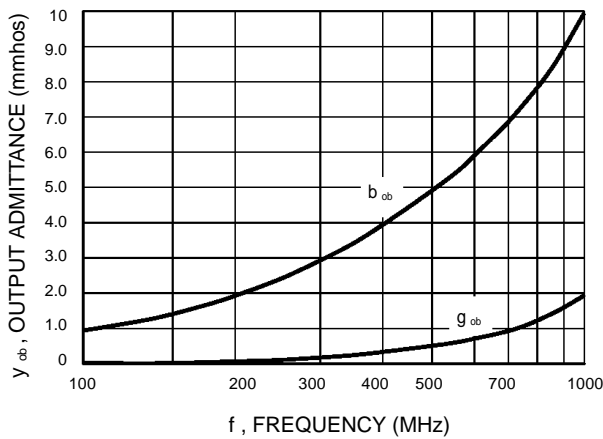

Figure 7. Rectangular Form

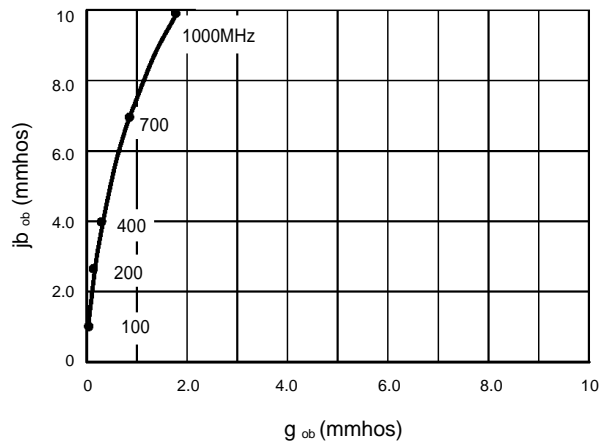
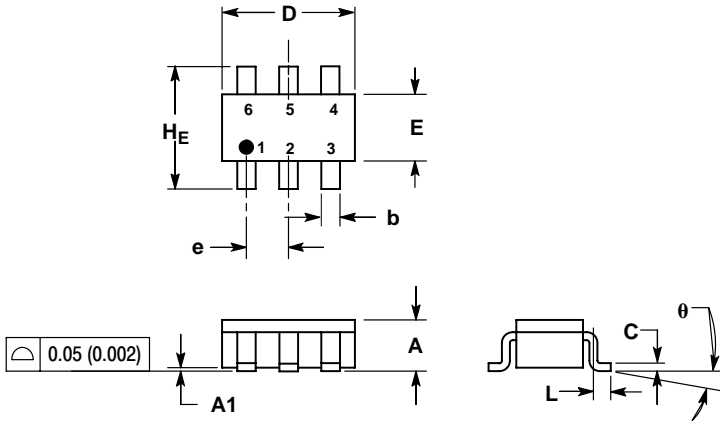

Figure 8. Polar Form

# LSBTH10T1G , S-LSBTH10T1G

## SC-74



DIM	MILLIMETERS			INCHES		
	MIN	NOM	MAX	MIN	NOM	MAX
A	0.90	1.00	1.10	0.035	0.039	0.043
A1	0.01	0.06	0.10	0.001	0.002	0.004
b	0.25	0.37	0.50	0.010	0.015	0.020
c	0.10	0.18	0.26	0.004	0.007	0.010
D	2.90	3.00	3.10	0.114	0.118	0.122
E	1.30	1.50	1.70	0.051	0.059	0.067
e	0.85	0.95	1.05	0.034	0.037	0.041
L	0.20	0.40	0.60	0.008	0.016	0.024
$H_E$	2.50	2.75	3.00	0.099	0.108	0.118
$\theta$	0°	-	10°	0°	-	10°

## EMBOSSED TAPE AND REEL DATA FOR DISCRETES

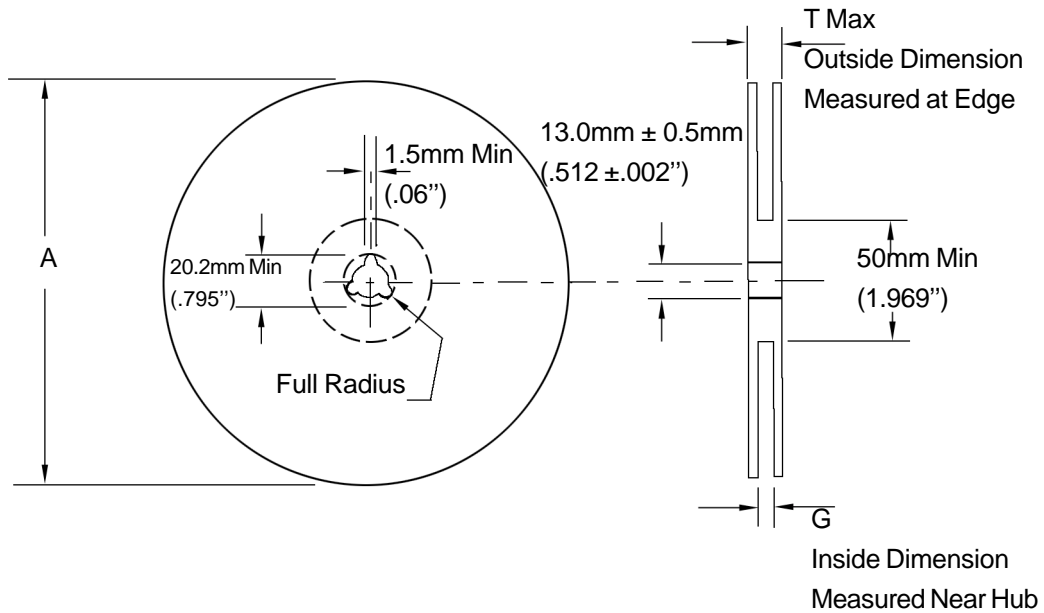

Size	A Max	G	T Max
8 mm	178.0mm (7.0")	8.4mm+1.5mm, -0.0 (.33"+.039", -0.00)	10.9mm (.43")

### Reel Dimensions

Metric Dimensions Govern — English are in parentheses for reference only

#### Storage Conditions

Temperature: 5 to 40 Deg.C (20 to 30 Deg. C is preferred)

Humidity: 30 to 80 RH (40 to 60 is preferred )

Recommended Period: One year after manufacturing

(This recommended period is for the soldering condition only. The characteristics and reliabilities of the products are not restricted to this limitation)

## Shipment Specification

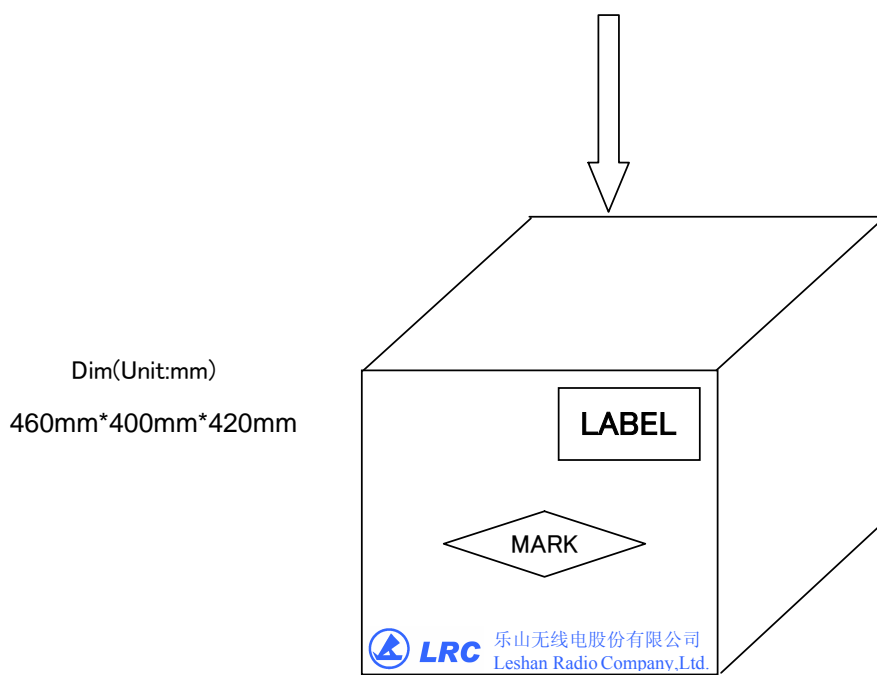
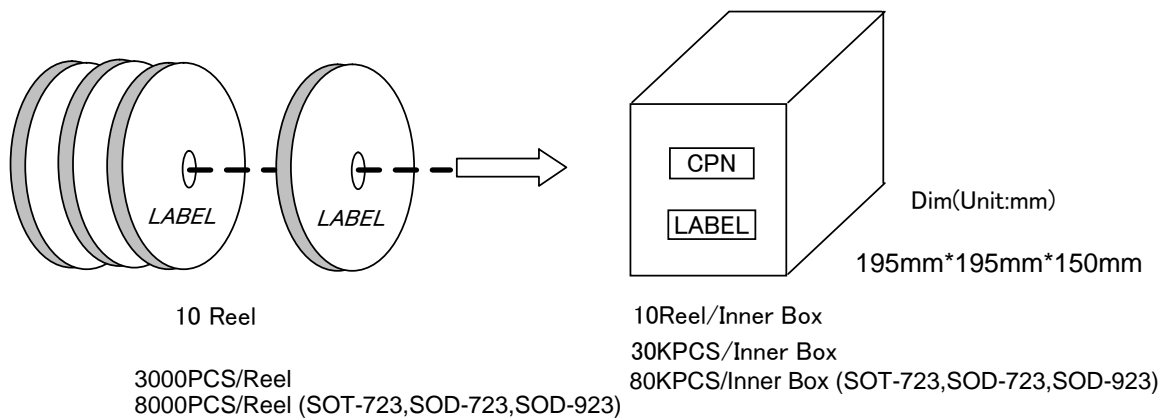

12 Inner Box/Carton

360KPCS/Carton  
960KPCS/Carton (SOT-723,SOD-723,SOD-923)