

PNP Transistors

MMBT4403W (KMBT4403W)

■ Features

- Switching transistors.
- Collector Current Capability $I_c = -600\text{mA}$
- Collector Emitter Voltage $V_{CE0} = -40\text{V}$

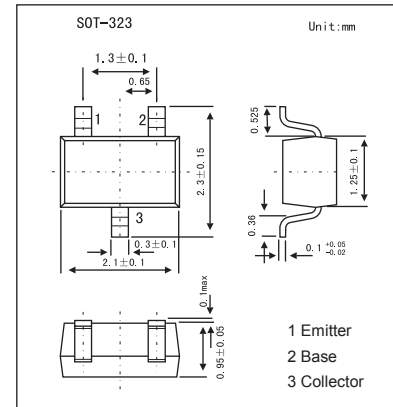

■ Absolute Maximum Ratings $T_a = 25^\circ\text{C}$

Parameter	Symbol	Rating	Unit
Collector-emitter voltage	V_{CE0}	-40	V
Collector-base voltage	V_{CB0}	-40	V
Emitter-base voltage	V_{EB0}	-5	V
Collector current	I_c	-600	mA
Total Device Dissipation FR-5 Board	P_D	150	mW
Thermal Resistance, Junction-to-Ambient	$R_{\theta JA}$	833	$^\circ\text{C}/\text{W}$
Junction temperature	T_j	150	$^\circ\text{C}$
Storage temperature	T_{stg}	-55 to +150	$^\circ\text{C}$

MMBT4403W (KMBT4403W)■ Electrical Characteristics $T_a = 25^\circ\text{C}$

Parameter	Symbol	Test conditions	Min	Typ	Max	Unit
Collector-emitter breakdown voltage *	$V_{(BR)CEO}$	$I_C = -1.0\text{ mA}, I_B = 0$	-40			V
Collector-base breakdown voltage	$V_{(BR)CBO}$	$I_C = -0.1\text{ mA}, I_E = 0$	-40			V
Emitter-base breakdown voltage	$V_{(BR)EBO}$	$I_E = -0.1\text{ mA}, I_C = 0$	-5			V
Base cutoff current	I_{BEV}	$V_{CE} = -35\text{ V}, V_{EB} = -0.4\text{ V}$			-0.1	μA
Collector cutoff current	I_{CEX}	$V_{CE} = -35\text{ V}, V_{EB} = -0.4\text{ V}$			-0.1	μA
DC current gain	HFE	$I_C = -0.1\text{ mA}, V_{CE} = -1.0\text{ V}$	30			
		$I_C = -1.0\text{ mA}, V_{CE} = -1.0\text{ V}$	60			
		$I_C = -10\text{ mA}, V_{CE} = -1.0\text{ V}$	100			
		$I_C = -150\text{ mA}, V_{CE} = -2.0\text{ V}^*$	100		300	
		$I_C = -500\text{ mA}, V_{CE} = -2.0\text{ V}^*$	20			
Collector-emitter saturation voltage *	$V_{CE(sat)}$	$I_C = -150\text{ mA}, I_B = -15\text{ mA}$			-0.4	V
		$I_C = -500\text{ mA}, I_B = -50\text{ mA}$			-0.75	
Base-emitter saturation voltage *	$V_{BE(sat)}$	$I_C = -150\text{ mA}, I_B = -15\text{ mA}$	-0.75		-0.95	
		$I_C = -500\text{ mA}, I_B = -50\text{ mA}$			-1.3	
Current-gain-bandwidth product	f_T	$I_C = -20\text{ mA}, V_{CE} = -10\text{ V}, f = 100\text{ MHz}$	200			MHz
Collector-base capacitance	C_{cb}	$V_{CB} = -10\text{ V}, I_E = 0, f = 1.0\text{ MHz}$			8.5	pF
Emitter-base capacitance	C_{eb}	$V_{BE} = -0.5\text{ V}, I_C = 0, f = 1.0\text{ MHz}$			30	pF
Input impedance	h_{ie}	$I_C = -1.0\text{ mA}, V_{CE} = -10\text{ V}, f = 1.0\text{ kHz}$	1.5		15	$\text{k}\Omega$
Voltage feedback ratio	h_{re}	$I_C = -1.0\text{ mA}, V_{CE} = -10\text{ V}, f = 1.0\text{ kHz}$	0.1		8.0	$\times 10^{-4}$
Small-signal current gain	h_{fe}	$I_C = -1.0\text{ mA}, V_{CE} = -10\text{ V}, f = 1.0\text{ kHz}$	60		500	
Output admittance	h_{oe}	$I_C = -1.0\text{ mA}, V_{CE} = -10\text{ V}, f = 1.0\text{ kHz}$	1.0		100	μmhos
Delay time	t_d	$V_{CC} = -30\text{ V}, V_{EB} = -2.0\text{ V},$ $I_C = -150\text{ mA}, I_{B1} = -15\text{ mA}$			15	ns
Rise time	t_r	$I_C = -150\text{ mA}, I_{B1} = -15\text{ mA}$			20	ns
Storage time	t_s	$V_{CC} = -30\text{ V}, I_C = -150\text{ mA},$ $I_{B1} = I_{B2} = -15\text{ mA}$			225	ns
Fall time	t_f	$I_{B1} = I_{B2} = -15\text{ mA}$			30	ns

* Pulse test: pulse width $\leq 300\text{ }\mu\text{s}$, duty cycle $\leq 2.0\%$.

■ Marking

Marking	2T
---------	----

MMBT4403W (KMBT4403W)

■ Typical Characteristics

TRANSIENT CHARACTERISTICS

— 25°C - - - 100°C

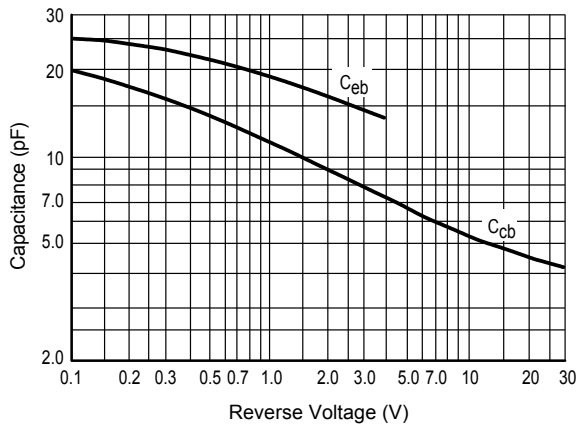

Figure 1. Capacitances

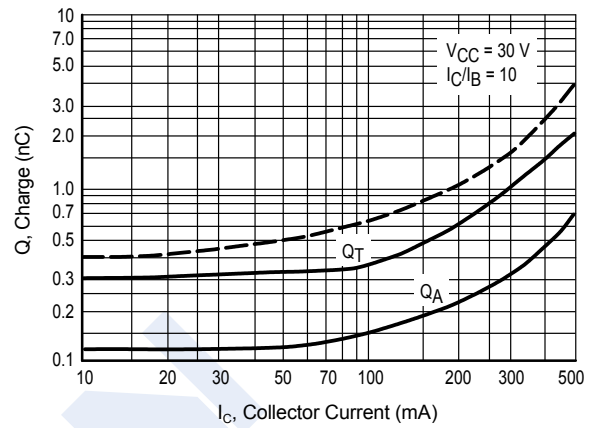

Figure 2. Charge Data

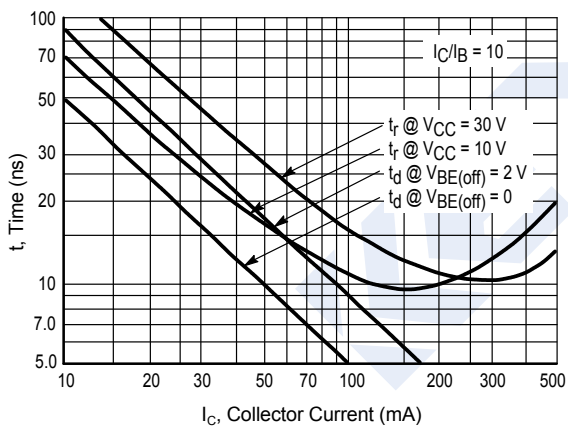

Figure 3. Turn-On Time

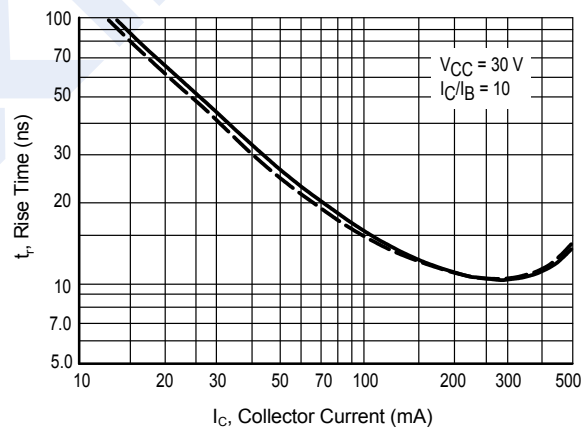

Figure 4. Rise Time

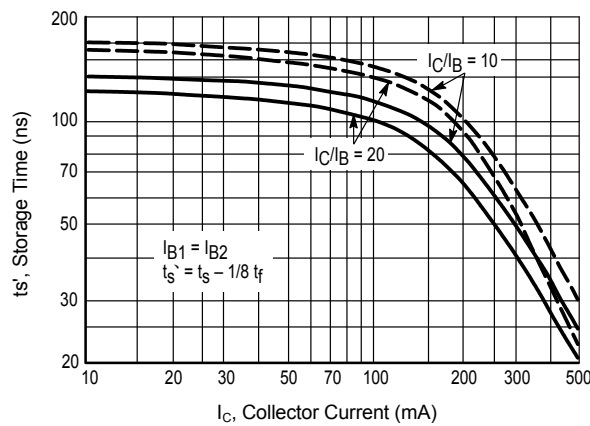

Figure 5. Storage Time

MMBT4403W (KMBT4403W)

■ Typical Characteristics

SMALL-SIGNAL CHARACTERISTICS

NOISE FIGURE

$V_{CE} = -10 \text{ Vdc}$, $T_A = 25^\circ\text{C}$

Bandwidth = 1.0 Hz

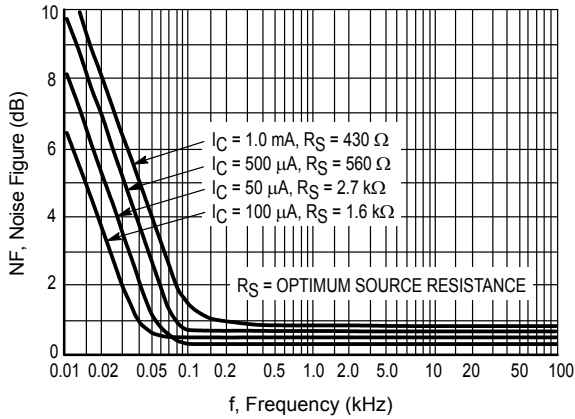

Figure 6. Frequency Effects

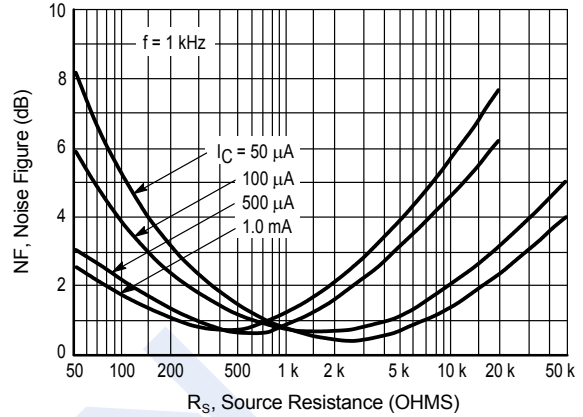

Figure 7. Source Resistance Effects

h PARAMETERS

$V_{CE} = -10 \text{ Vdc}$, $f = 1.0 \text{ kHz}$, $T_A = 25^\circ\text{C}$

This group of graphs illustrates the relationship between h_{fe} and other "h" parameters for this series of transistors. To obtain these curves, a high-gain and a low-gain unit were

selected from the MMBT4403W lines, and the same units were used to develop the correspondingly-numbered curves on each graph.

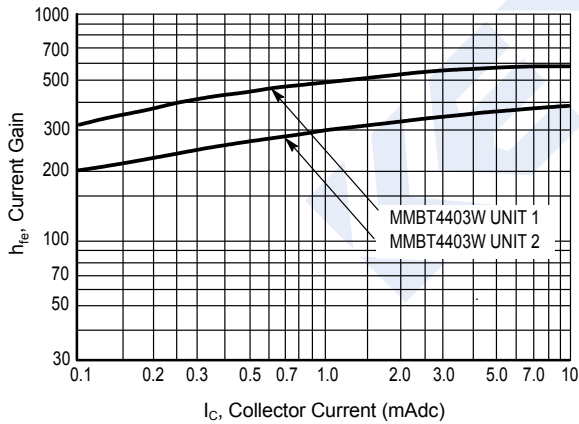

Figure 8. Current Gain

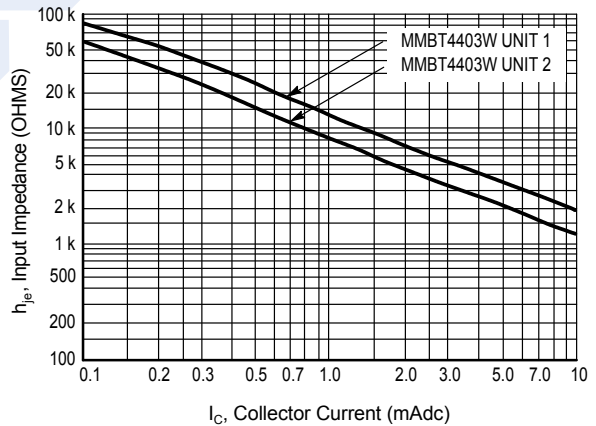

Figure 9. Input Impedance

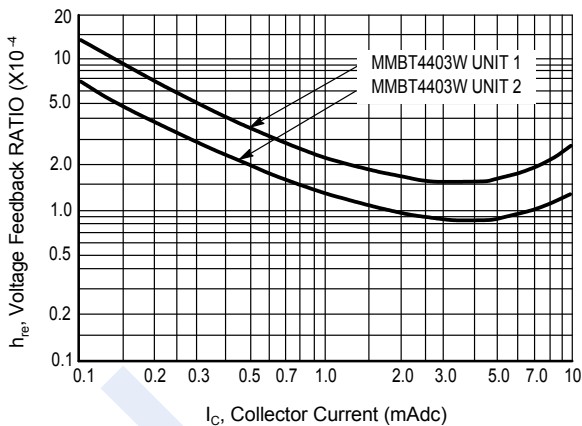

Figure 10. Voltage Feedback Ratio

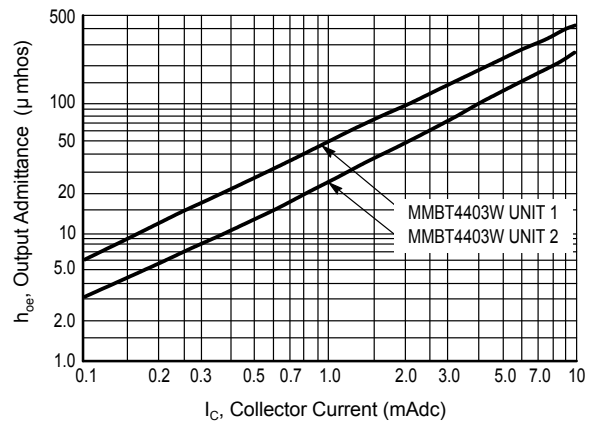

Figure 11. Output Admittance

MMBT4403W (KMBT4403W)

■ Typical Characteristics

STATIC CHARACTERISTICS

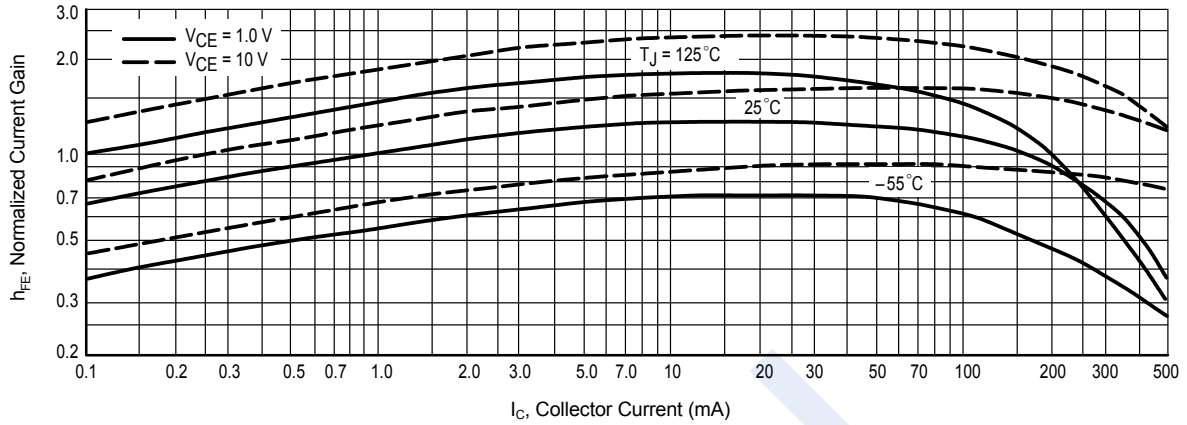

Figure 12. DC Current Gain

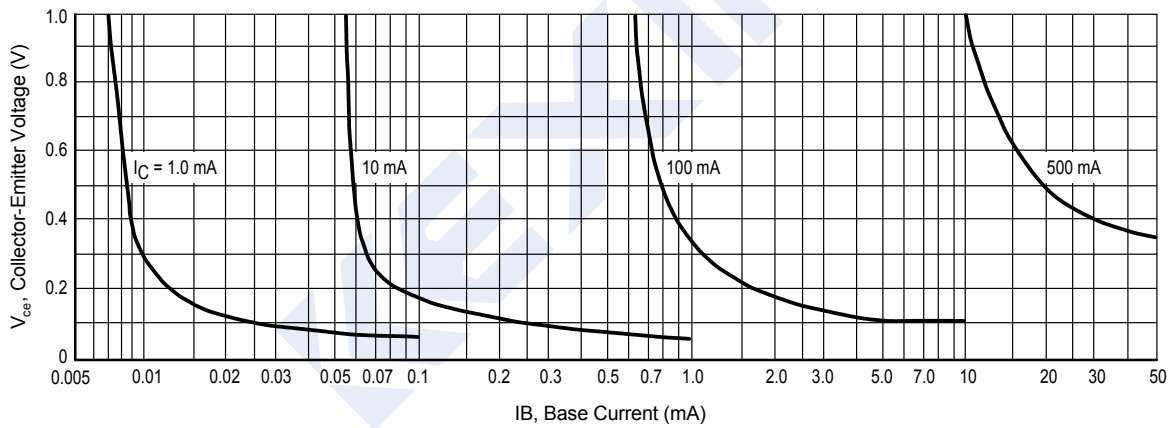

Figure 13. Collector Saturation Region

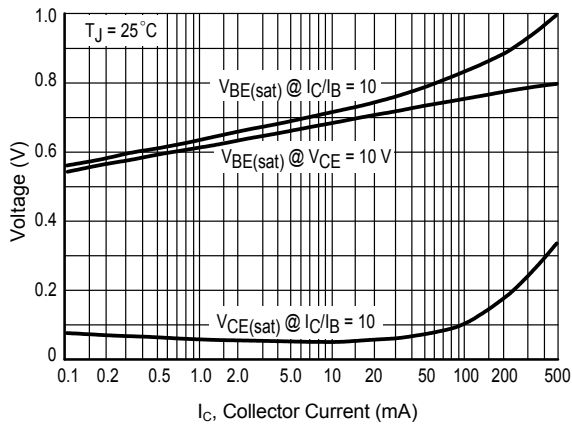

Figure 14. "On" Voltages

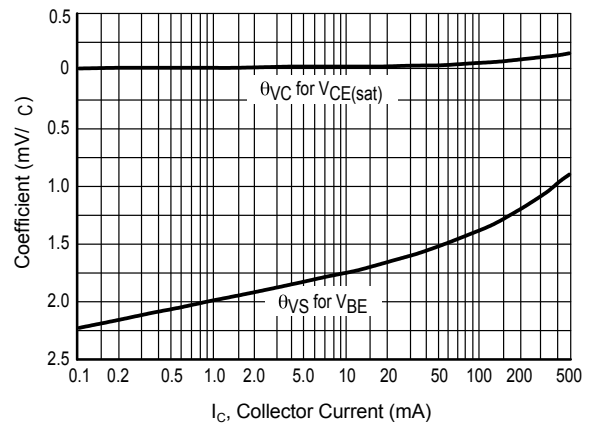

Figure 15. Temperature Coefficients