

S1PDB60

Single Phase Bridge Rectifiers Modules

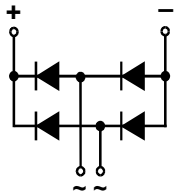
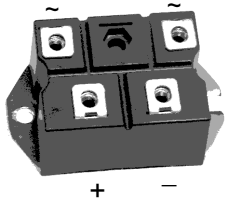

Type	V_{RSM} V	V_{RRM} V
S1PDB60N08	900	800
S1PDB60N10	1100	1000
S1PDB60N12	1300	1200
S1PDB60N14	1500	1400
S1PDB60N16	1700	1600
S1PDB60N18	1900	1800

Dimensions in mm (1mm=0.0394")

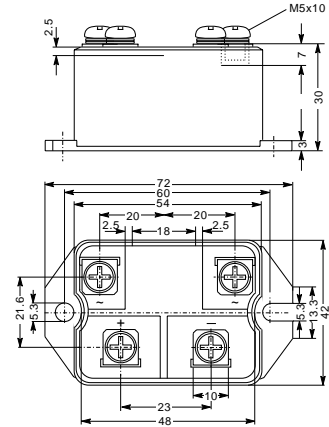

Symbol	Test Conditions	Maximum Ratings	Unit
I_{dav}	$T_C=100^{\circ}C$, module	60	A
I_{dav}	$T_A=45^{\circ}C$ ($R_{thCA}=0.6K/W$), module	48	
I_{FSM}	$T_{VJ}=45^{\circ}C$ $V_R=0$ $t=10ms$ (50Hz), sine $t=8.3ms$ (60Hz), sine	550 600	A
	$T_{VJ}=T_{VJM}$ $V_R=0$ $t=10ms$ (50Hz), sine $t=8.3ms$ (60Hz), sine	500 550	
I^2t	$T_{VJ}=45^{\circ}C$ $V_R=0$ $t=10ms$ (50Hz), sine $t=8.3ms$ (60Hz), sine	1520 1520	A^2s
	$T_{VJ}=T_{VJM}$ $V_R=0$ $t=10ms$ (50Hz), sine $t=8.3ms$ (60Hz), sine	1250 1250	
T_{VJ} T_{VJM} T_{stg}		-40...+150 150 -40...+125	$^{\circ}C$
V_{ISOL}	50/60Hz, RMS $I_{ISOL} \leq 1mA$ $t=1min$ $t=1s$	2500 3000	V~
M_d	Mounting torque (M5) Terminal connection torque (M5)	$5 \pm 15\%$ $5 \pm 15\%$	Nm
Weight	typ.	160	g

S1PDB60

Single Phase Bridge Rectifiers Modules

Symbol	Test Conditions	Characteristic Values	Unit
I_R	$V_R=V_{RRM}; T_{VJ}=25^{\circ}\text{C}$ $V_R=V_{RRM}; T_{VJ}=T_{VJM}$	≤ 0.3 ≤ 5	mA
V_F	$I_F=150\text{A}; T_{VJ}=25^{\circ}\text{C}$	≤ 1.8	V
V_{TO}	For power-loss calculations only	0.8	V
r_T	$T_{VJ}=T_{VJM}$	8	$\text{m}\Omega$
R_{thJC}	per diode per module	1.45 0.24	K/W
R_{thJK}	per diode per module	1.87 0.31	K/W
d_s	Creeping distance on surface	10	mm
d_A	Creepage distance in air	9.4	mm
a	Max. allowable acceleration	50	m/s^2

FEATURES

- * Package with screw terminals
- * Isolation voltage 3000 V~
- * Planar passivated chips
- * Blocking voltage up to 1800 V
- * Low forward voltage drop

APPLICATIONS

- * Supplies for DC power equipment
- * Input rectifiers for PWM inverter
- * Battery DC power supplies
- * Field supply for DC motors

ADVANTAGES

- * Easy to mount with two screws
- * Space and weight savings
- * Improved temperature and power cycling