

MUR12060

Ultra Fast Recovery Diodes

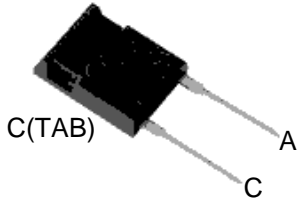

A=Anode, C=Cathode, TAB=Cathode

Dimensions TO-247AC

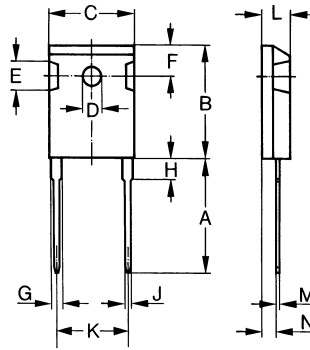

Dim.	Millimeter		Inches	
	Min.	Max.	Min.	Max.
A	19.81	20.32	0.780	0.800
B	20.80	21.46	0.819	0.845
C	15.75	16.26	0.610	0.640
D	3.55	3.65	0.140	0.144
E	4.32	5.49	0.170	0.216
F	5.4	6.2	0.212	0.244
G	1.65	2.13	0.065	0.084
H	-	4.5	-	0.177
J	1.0	1.4	0.040	0.055
K	10.8	11.0	0.426	0.433
L	4.7	5.3	0.185	0.209
M	0.4	0.8	0.016	0.031
N	1.5	2.49	0.087	0.102

	V_{RSM}	V_{RRM}
	V	V
MUR12060	600	600

Symbol	Test Conditions	Maximum Ratings	Unit
I_{FRMS}	$T_{VJ}=T_{VJM}$	100	A
I_{FAVM}	$T_C=70^\circ\text{C}$; rectangular, $d=0.5$	126	
I_{FAV}	$T_C=110^\circ\text{C}$; rectangular, $d=0.5$	77	
I_{FRM}	$t_p < 10\mu\text{s}$; rep. rating, pulse width limited by T_{VJM}	tbd	
I_{FSM}	$T_{VJ}=45^\circ\text{C}$	$t=10\text{ms}$ (50Hz), sine $t=8.3\text{ms}$ (60Hz), sine	A
	$T_{VJ}=150^\circ\text{C}$	$t=10\text{ms}$ (50Hz), sine $t=8.3\text{ms}$ (60Hz), sine	
I^2t	$T_{VJ}=45^\circ\text{C}$	$t=10\text{ms}$ (50Hz), sine $t=8.3\text{ms}$ (60Hz), sine	A^2s
	$T_{VJ}=150^\circ\text{C}$	$t=10\text{ms}$ (50Hz), sine $t=8.3\text{ms}$ (60Hz), sine	
T_{VJ}		-40...+150	$^\circ\text{C}$
T_{VJM}		150	
T_{stg}		-40...+150	
P_{tot}	$T_C=25^\circ\text{C}$	357	W
M_d	Mounting torque	0.8...1.2	Nm
Weight		6	g

MUR12060

Ultra Fast Recovery Diodes

Symbol	Test Conditions	Characteristic Values		Unit
		typ.	max.	
I_R	$T_{VJ}=25^{\circ}\text{C}; V_R=V_{RRM}$		3	mA
	$T_{VJ}=25^{\circ}\text{C}; V_R=0.8 \cdot V_{RRM}$		0.75	
	$T_{VJ}=125^{\circ}\text{C}; V_R=0.8 \cdot V_{RRM}$		20	
V_F	$I_F=70\text{A}; T_{VJ}=150^{\circ}\text{C}$		1.12	V
	$T_{VJ}=25^{\circ}\text{C}$		1.3	
V_{TO}	For power-loss calculations only		0.85	V
r_T	$T_{VJ}=T_{VJM}$		3.5	m Ω
R_{thJC} R_{thCK} R_{thJA}		0.25	0.35 35	K/W
t_{rr}	$I_F=1\text{A}; -di/dt=200\text{A}/\mu\text{s}; V_R=30\text{V}; T_{VJ}=25^{\circ}\text{C}$	35	50	ns
I_{RM}	$V_R=350\text{V}; I_F=80\text{A}; -di_F/dt=200\text{A}/\mu\text{s}; L \leq 0.05\mu\text{H}; T_{VJ}=100^{\circ}\text{C}$	17	21	A

FEATURES

- * International standard package JEDEC TO-247AC
- * Planar passivated chips
- * Very short recovery time
- * Extremely low switching losses
- * Low I_{RM}-values
- * Soft recovery behaviour

APPLICATIONS

- * Antiparallel diode for high frequency switching devices
- * Antisaturation diode
- * Snubber diode
- * Free wheeling diode in converters and motor control circuits
- * Rectifiers in switch mode power supplies (SMPS)
- * Inductive heating and melting
- * Uninterruptible power supplies (UPS)
- * Ultrasonic cleaners and welders

ADVANTAGES

- * High reliability circuit operation
- * Low voltage peaks for reduced protection circuits
- * Low noise switching
- * Low losses
- * Operating at lower temperature or space saving by reduced cooling

MUR12060

Ultra Fast Recovery Diodes

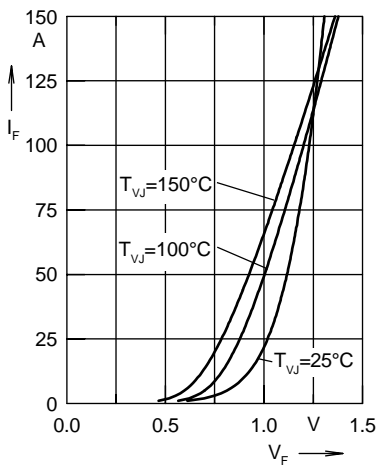

Fig. 1 Forward current I_F versus V_F

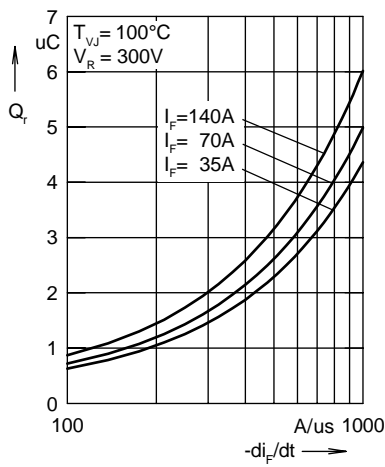

Fig. 2 Reverse recovery charge Q_r versus $-di_F/dt$

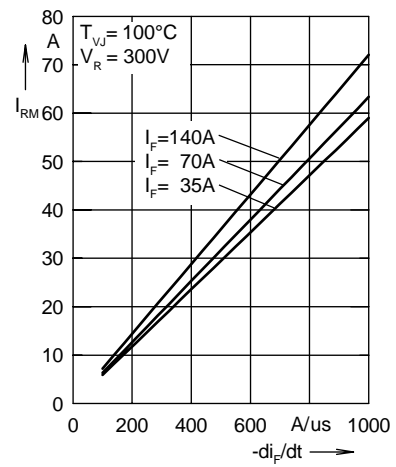

Fig. 3 Peak reverse current I_{RM} versus $-di_F/dt$

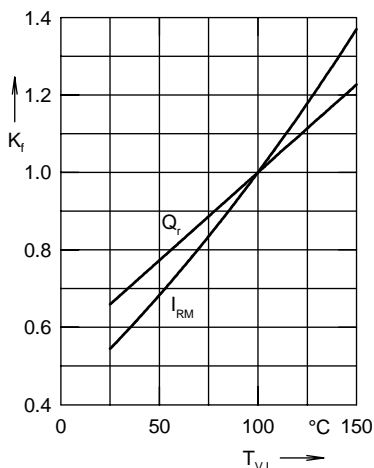

Fig. 4 Dynamic parameters Q_r , I_{RM} versus T_{VJ}

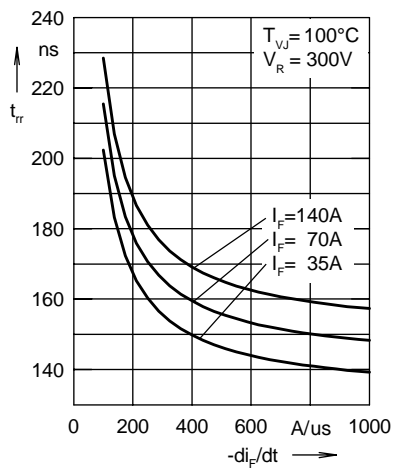

Fig. 5 Recovery time t_{tr} versus $-di_F/dt$

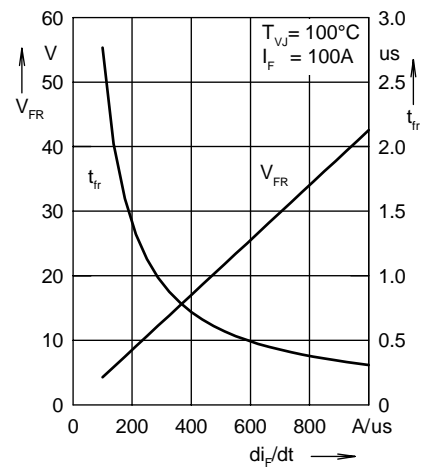

Fig. 6 Peak forward voltage V_{FR} and t_{tr} versus di_F/dt

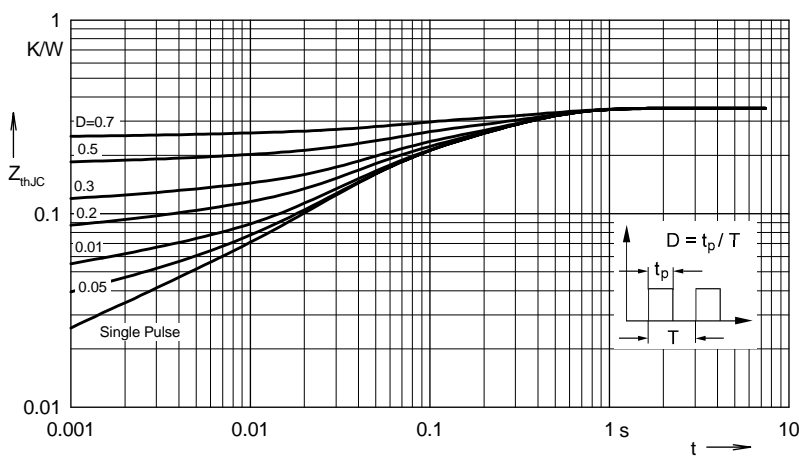

Fig. 7 Transient thermal resistance junction to case at various duty cycles

Constants for Z_{thJC} calculation:

i	R_{thi} (K/W)	t_i (s)
1	0.017	0.00038
2	0.0184	0.0026
3	0.1296	0.0387
4	0.185	0.274