

**FEATURES**

- Low Reverse Recovery Charge
- High Switching Speed
- Low Forward Volt Drop
- Isolated AISiC Base with AlN Substrates
- Dual Diodes can be paralleled for 1000A Rating
- Lead Free Construction
- 10.2kV Isolation Package

**APPLICATIONS**

- Brake Chopper Diodes
- Boost and Buck Circuits
- Free-wheel Circuits
- Motor Drives
- Resonant Converters
- Induction Heating
- Multi-level Switch Inverters

The DFM500XXM65-TS000 is a dual 6500V, fast recovery diode (FRD) module. Designed for low power loss, the module is suitable for a variety of high voltage applications in motor drives and power conversion.

Fast switching times and low reverse recovery losses allow high frequency operation, making the device suitable for the latest drive designs employing PWM and high frequency switching.

The module incorporates an electrically isolated base plate and low inductance construction enabling circuit designers to optimise circuit layouts and utilise grounded heat sinks for safety.

**ORDERING INFORMATION**

Order As:

**DFM500XXM65-TS000**

Note: When ordering, please use the complete part number

**KEY PARAMETERS**

$V_{RRM}$		<b>6500V</b>
$V_F$	(typ)	<b>3.1V</b>
$I_F$	(max)	<b>500A</b>
$I_{FM}$	(max)	<b>1000A</b>

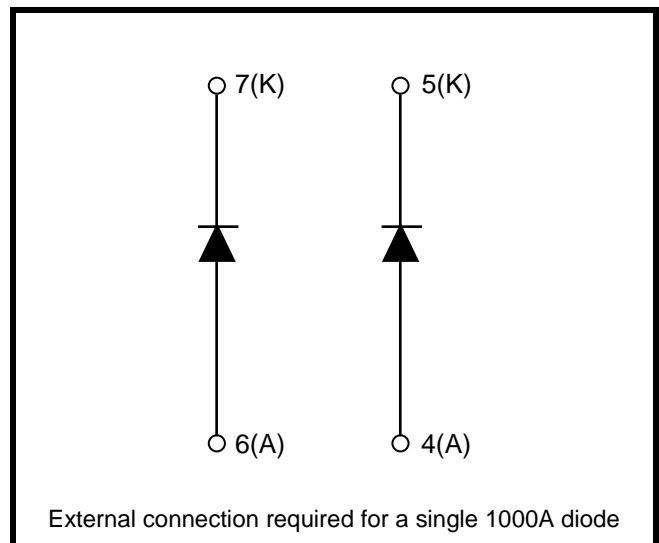

**Fig. 1 Circuit configuration**

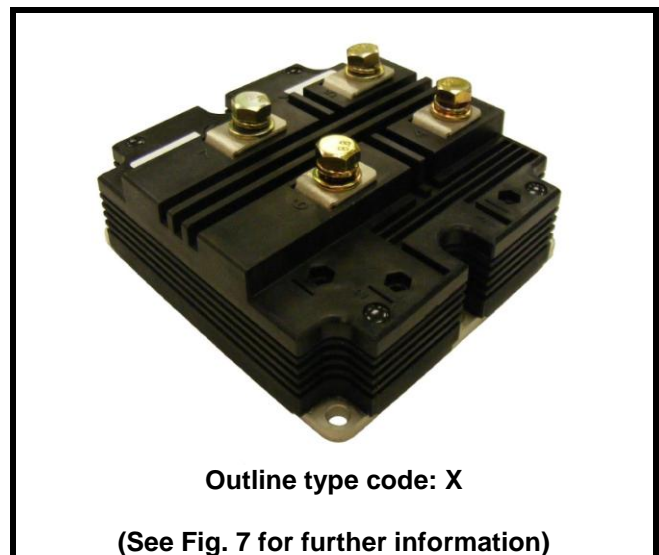

**Fig. 2 Package**

## ABSOLUTE MAXIMUM RATINGS

Stresses above those listed under 'Absolute Maximum Ratings' may cause permanent damage to the device. In extreme conditions, as with all semiconductors, this may include potentially hazardous rupture of the package. Appropriate safety precautions should always be followed. Exposure to Absolute Maximum Ratings may affect device reliability.

$T_{case} = 25^{\circ}\text{C}$  unless stated otherwise

Symbol	Parameter	Test Conditions	Max.	Units
$V_{RRM}$	Repetitive peak reverse voltage	$T_j = 125^{\circ}\text{C}$	6500	V
		$T_j = 25^{\circ}\text{C}$	6300	V
		$T_j = -40^{\circ}\text{C}$	5800	V
$I_F$	Forward current (per arm)	DC, $T_{case} = 70^{\circ}\text{C}$ , $T_j = 125^{\circ}\text{C}$	500	A
$I_{FM}$	Max. forward current	$T_{case} = 115^{\circ}\text{C}$ , $t_p = 1\text{ms}$	1000	A
$I^2t$	$I^2t$ value fuse current rating	$V_R = 0$ , $t_p = 10\text{ms}$ , $T_j = 125^{\circ}\text{C}$	100	$\text{kA}^2\text{s}$
$P_{max}$	Max. power dissipation	$T_{case} = 25^{\circ}\text{C}$ , $T_j = 125^{\circ}\text{C}$	3300	W
$V_{isol}$	Isolation voltage – per module	Commoned terminals to base plate. AC RMS, 1 min, 50Hz	10.2	kV
$Q_{PD}$	Partial discharge – per module	IEC1287, $V_1 = 6900\text{V}$ , $V_2 = 5100\text{V}$ , 50Hz RMS	10	pC

## THERMAL AND MECHANICAL RATINGS

Internal insulation material:	AlN
Baseplate material:	AlSiC
Creepage distance:	56mm
Clearance:	26mm
CTI (Comparative Tracking Index):	> 600

Symbol	Parameter	Test Conditions	Min	Typ.	Max	Units
$R_{th(j-c)}$	Thermal resistance (per arm)	Continuous dissipation – junction to case	-	-	30	$^{\circ}\text{C}/\text{kW}$
$R_{th(c-h)}$	Thermal resistance – case to heatsink (per module)	Mounting torque 5Nm (with mounting grease)	-	-	8	$^{\circ}\text{C}/\text{kW}$
$T_j$	Junction temperature		-40	-	150	$^{\circ}\text{C}$
$T_{stg}$	Storage temperature range		-40	-	150	$^{\circ}\text{C}$
	Screw Torque	Mounting – M6	-	-	5	Nm
		Electrical connections – M8	-	-	10	Nm

**STATIC ELECTRICAL CHARACTERISTICS – PER ARM**
**T<sub>case</sub> = 25°C unless stated otherwise.**

Symbol	Parameter	Test Conditions	Min	Typ	Max	Units
I <sub>RM</sub>	Peak reverse current	V <sub>R</sub> = 6500V, T <sub>j</sub> = 125°C			50	mA
V <sub>F</sub>	Forward voltage	I <sub>F</sub> = 500A		3.1		V
		I <sub>F</sub> = 500A, T <sub>j</sub> = 125°C		3.5		V
L <sub>M</sub>	Inductance	-		40		nH

**STATIC ELECTRICAL CHARACTERISTICS**
**T<sub>case</sub> = 25°C unless stated otherwise.**

Symbol	Parameter	Test Conditions	Min	Typ	Max	Units
L <sub>M</sub>	Module inductance (externally connected in parallel)	-		20		nH
R <sub>INT</sub>	Internal resistance (per arm)	-		370		μΩ

**DYNAMIC ELECTRICAL CHARACTERISTICS – PER ARM**
**T<sub>case</sub> = 25°C unless stated otherwise**

Symbol	Parameter	Test Conditions	Min	Typ.	Max	Units
Q <sub>rr</sub>	Reverse recovery charge	I <sub>F</sub> = 500A V <sub>R</sub> = 3600V di <sub>F</sub> /dt = 2000A/μs		900		μC
I <sub>rr</sub>	Peak reverse recovery current			450		A
E <sub>rec</sub>	Reverse recovery energy			1950		mJ

**T<sub>case</sub> = 125°C unless stated otherwise**

Symbol	Parameter	Test Conditions	Min	Typ.	Max	Units
Q <sub>rr</sub>	Reverse recovery charge	I <sub>F</sub> = 500A V <sub>R</sub> = 3600V di <sub>F</sub> /dt = 2000A/μs		1300		μC
I <sub>rr</sub>	Peak reverse recovery current			560		A
E <sub>rec</sub>	Reverse recovery energy			2900		mJ

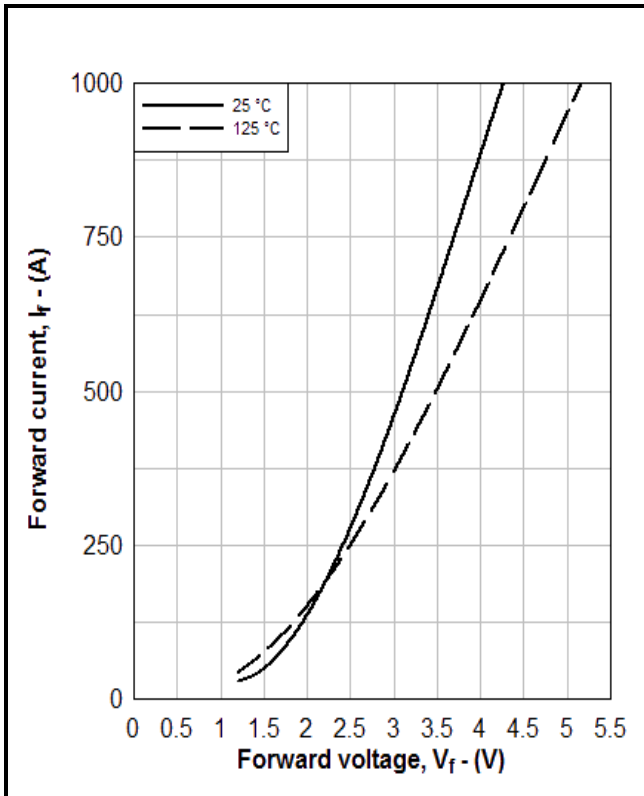

Fig. 3 Diode typical forward characteristics

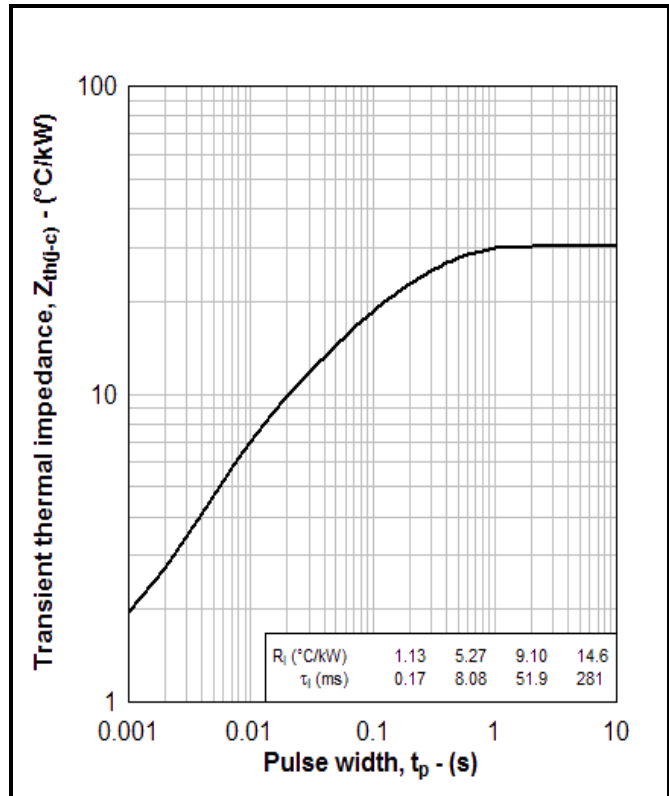

Fig. 4 Transient thermal impedance

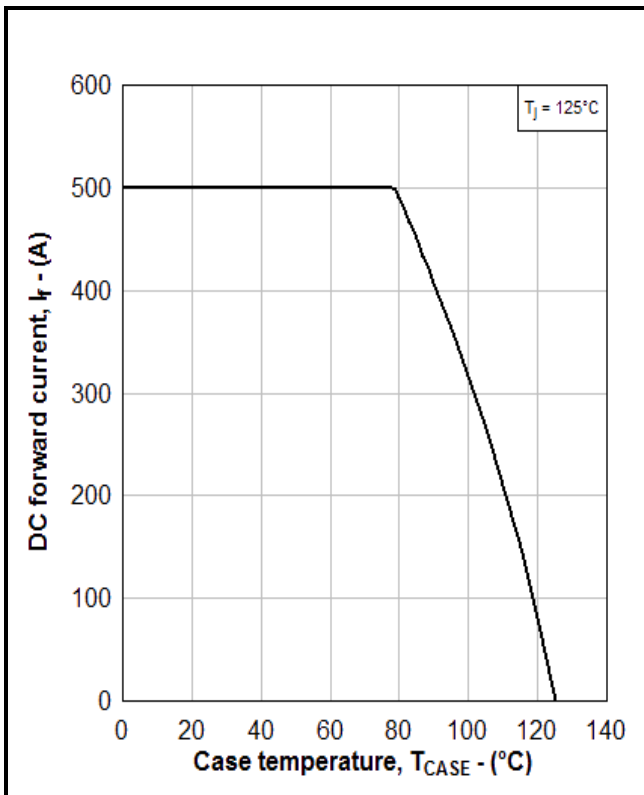

Fig. 5 DC current rating vs case temperature

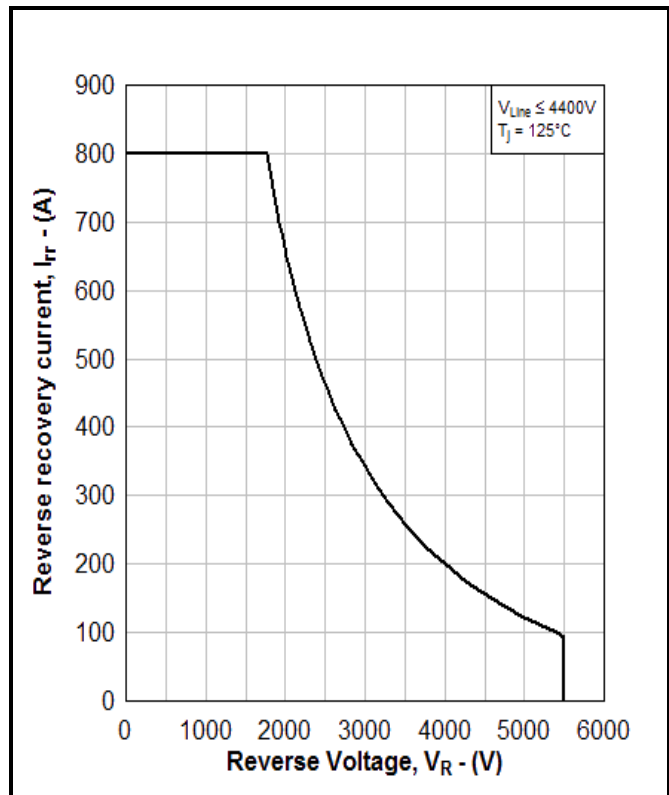
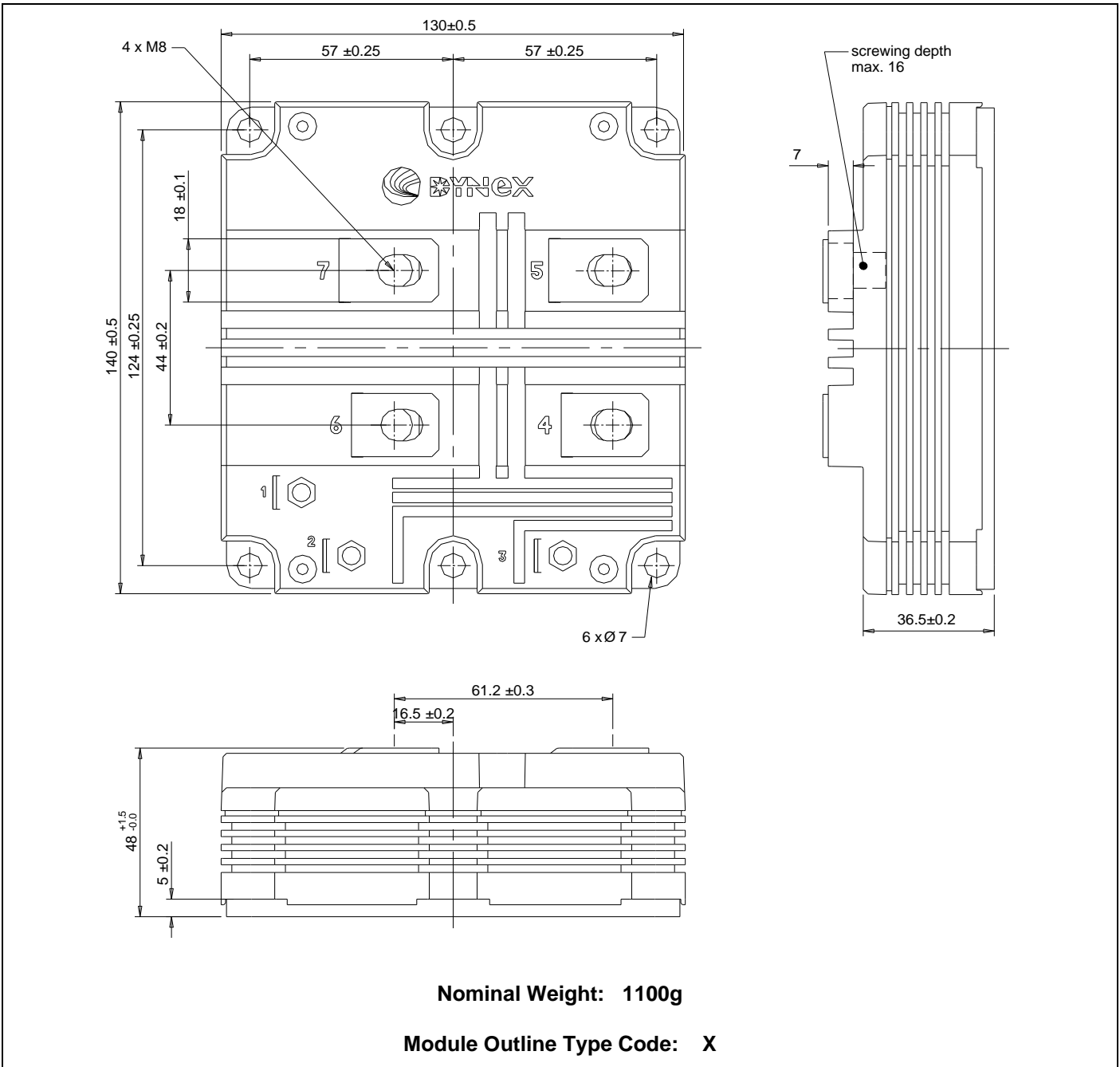

Fig. 6 Reverse Bias Safe Operating Area (RBSOA)

**PACKAGE DETAILS**

For further package information, please visit our website or contact Customer Services.  
 All dimensions in mm, unless stated otherwise.  
**DO NOT SCALE.**



**Nominal Weight: 1100g**

**Module Outline Type Code: X**

**Fig. 7 Module outline drawing**

## IMPORTANT INFORMATION:

This publication is provided for information only and not for resale.

The products and information in this publication are intended for use by appropriately trained technical personnel.

Due to the diversity of product applications, the information contained herein is provided as a general guide only and does not constitute any guarantee of suitability for use in a specific application. The user must evaluate the suitability of the product and the completeness of the product data for the application. The user is responsible for product selection and ensuring all safety and any warning requirements are met. Should additional product information be needed please contact Customer Service.

Although we have endeavoured to carefully compile the information in this publication it may contain inaccuracies or typographical errors. The information is provided without any warranty or guarantee of any kind.

This publication is an uncontrolled document and is subject to change without notice. When referring to it please ensure that it is the most up to date version and has not been superseded.

The products are not intended for use in applications where a failure or malfunction may cause loss of life, injury or damage to property. The user must ensure that appropriate safety precautions are taken to prevent or mitigate the consequences of a product failure or malfunction.

The products must not be touched when operating because there is a danger of electrocution or severe burning. Always use protective safety equipment such as appropriate shields for the product and wear safety glasses. Even when disconnected any electric charge remaining in the product must be discharged and allowed to cool before safe handling using protective gloves.

Extended exposure to conditions outside the product ratings may affect reliability leading to premature product failure. Use outside the product ratings is likely to cause permanent damage to the product. In extreme conditions, as with all semiconductors, this may include potentially hazardous rupture, a large current to flow or high voltage arcing, resulting in fire or explosion. Appropriate application design and safety precautions should always be followed to protect persons and property.

### Product Status & Product Ordering:

We annotate datasheets in the top right hand corner of the front page, to indicate product status if it is not yet fully approved for production. The annotations are as follows:-

<b>Target Information:</b>	This is the most tentative form of information and represents a very preliminary specification. No actual design work on the product has been started.
<b>Preliminary Information:</b>	The product design is complete and final characterisation for volume production is in progress. The datasheet represents the product as it is now understood but details may change.
<b>No Annotation:</b>	The product has been approved for production and unless otherwise notified by Dynex any product ordered will be supplied to the <b>current version of the data sheet prevailing at the time of our order acknowledgement.</b>

All products and materials are sold and services provided subject to Dynex's conditions of sale, which are available on request.

Any brand names and product names used in this publication are trademarks, registered trademarks or trade names of their respective owners.

## HEADQUARTERS OPERATIONS

### DYNEX SEMICONDUCTOR LTD

Doddington Road, Lincoln, Lincolnshire, LN6 3LF,  
United Kingdom

Fax: +44(0)1522 500550

Tel: +44(0)1522 500500

Web: <http://www.dynexsemi.com>

## CUSTOMER SERVICE

### DYNEX SEMICONDUCTOR LTD

Doddington Road, Lincoln, Lincolnshire, LN6 3LF,  
United Kingdom

Fax: +44(0)1522 500020

Tel: +44(0)1522 502753 / 502901

Email: [Power\\_solutions@dynexsemi.com](mailto:Power_solutions@dynexsemi.com)