

20A 200V 31ns

カソードコモン Fast Recovery
Cathode common

Similar to TO-263

UCU20C20

仕様書
Specification.日本インター株式会社
Nihon Inter Electronics Corporation

構造 拡散型シリコンダイオード (FRD)
 Construction Diffusion Type Silicon Diode
 用途 高周波整流用
 Application High Frequency Rectification

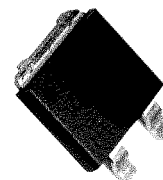

■ 最大定格 MAXIMUM RATINGS $T_a=25^\circ\text{C}$: Unless otherwise specified

Item	Symbol	Condition	Max. Rated value	Unit
くり返しピーク逆電圧 Repetitive peak reverse voltage	V_{RRM}		200	V
平均整流電流 Average rectified forward current	I_O	50Hz 正弦全波, 抵抗負荷 $T_c=104^\circ\text{C}$ 50Hz full sine wave, Resistance load	20	A
実効順電流 R.M.S. forward current	I_{FRMS}		22.2	A
サージ順電流 Surge forward current	I_{FSM}	50Hz 正弦全波 1 サイクル 非くり返し 50Hz full sine wave 1 cycle, non-repetitive	120	A
動作接合温度範囲 Operating junction temperature range	T_{jw}		-40~+150	$^\circ\text{C}$
保存温度範囲 Storage temperature range	T_{stg}		-40~+150	$^\circ\text{C}$

■ 電氣的・熱的特性 ELECTRICAL/THERMAL CHARACTERISTICS

Item	Symbol	Condition	Min.	Typ.	Max.	Unit
ピーク逆電流 Peak reverse current	I_{RM}	$V_{RM}=V_{RRM}$ $T_j=25^\circ\text{C}$ 1 素子あたり per diode	—	—	25	μA
ピーク順電圧 Peak forward voltage	V_{FM}	$I_{FM}=10\text{A}$ $T_j=25^\circ\text{C}$ 1 素子あたり per diode	—	0.90	1.08	V
逆回復時間 Reverse Recovery time	t_{rr}	$I_{FM}=10\text{A}$ $T_j=25^\circ\text{C}$ $-di/dt=50\text{A}/\mu\text{s}$	—	22	31	ns
熱抵抗 Thermal resistance	$R_{th(j-c)}$	接合部・ケース間 Junction to case	—	—	2	$^\circ\text{C}/\text{W}$

順電壓特性
FORWARD CURRENT VS. VOLTAGE

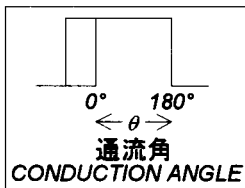
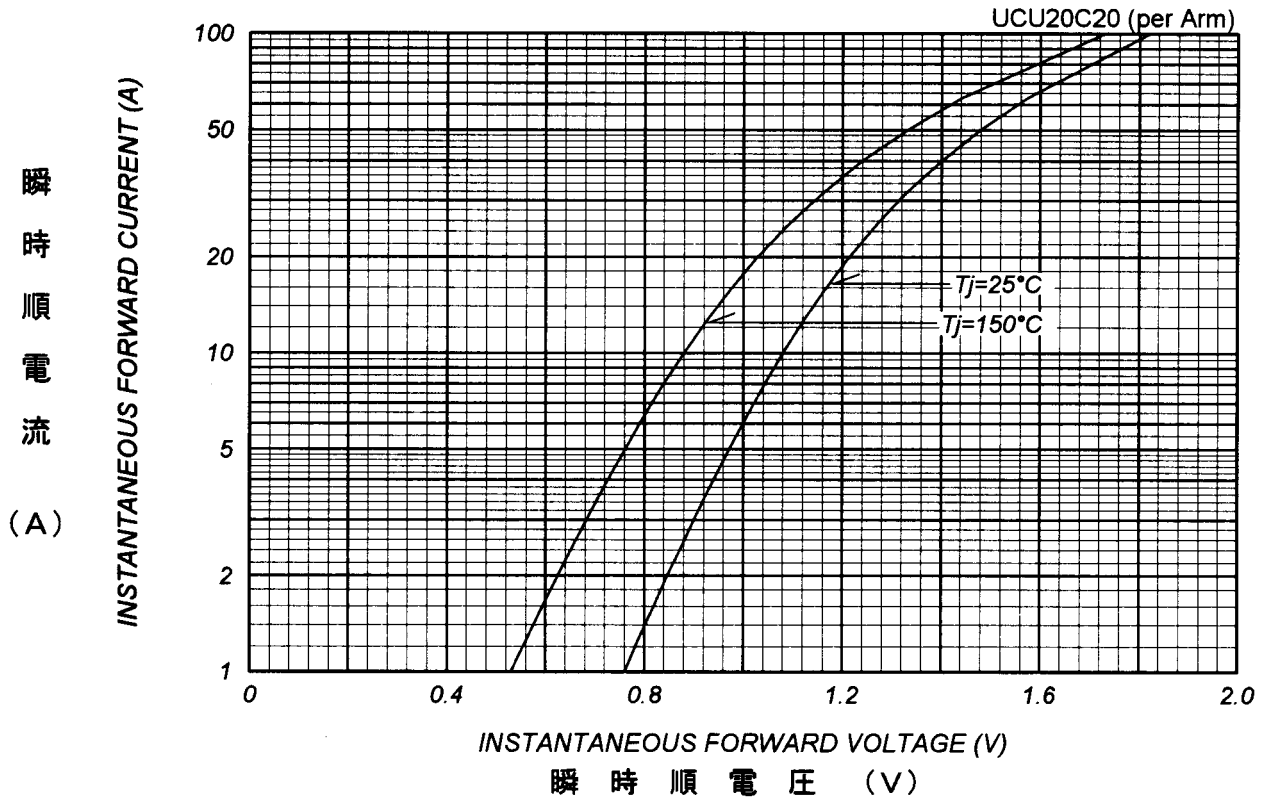

平均順電力損失特性
AVERAGE FORWARD POWER DISSIPATION

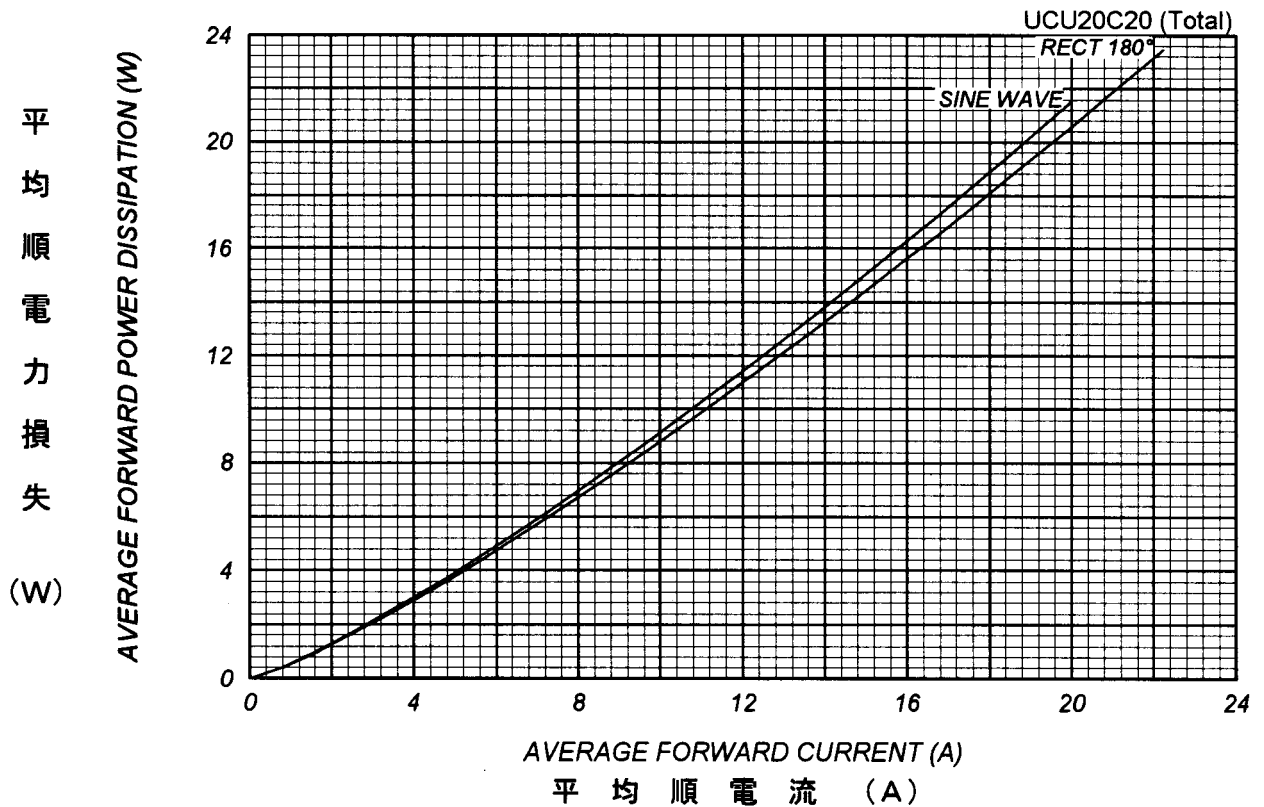

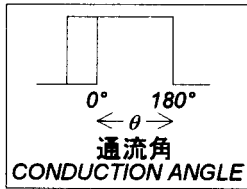

平均順電流 - ケース温度定格
AVERAGE FORWARD CURRENT VS. CASE TEMPERATURE

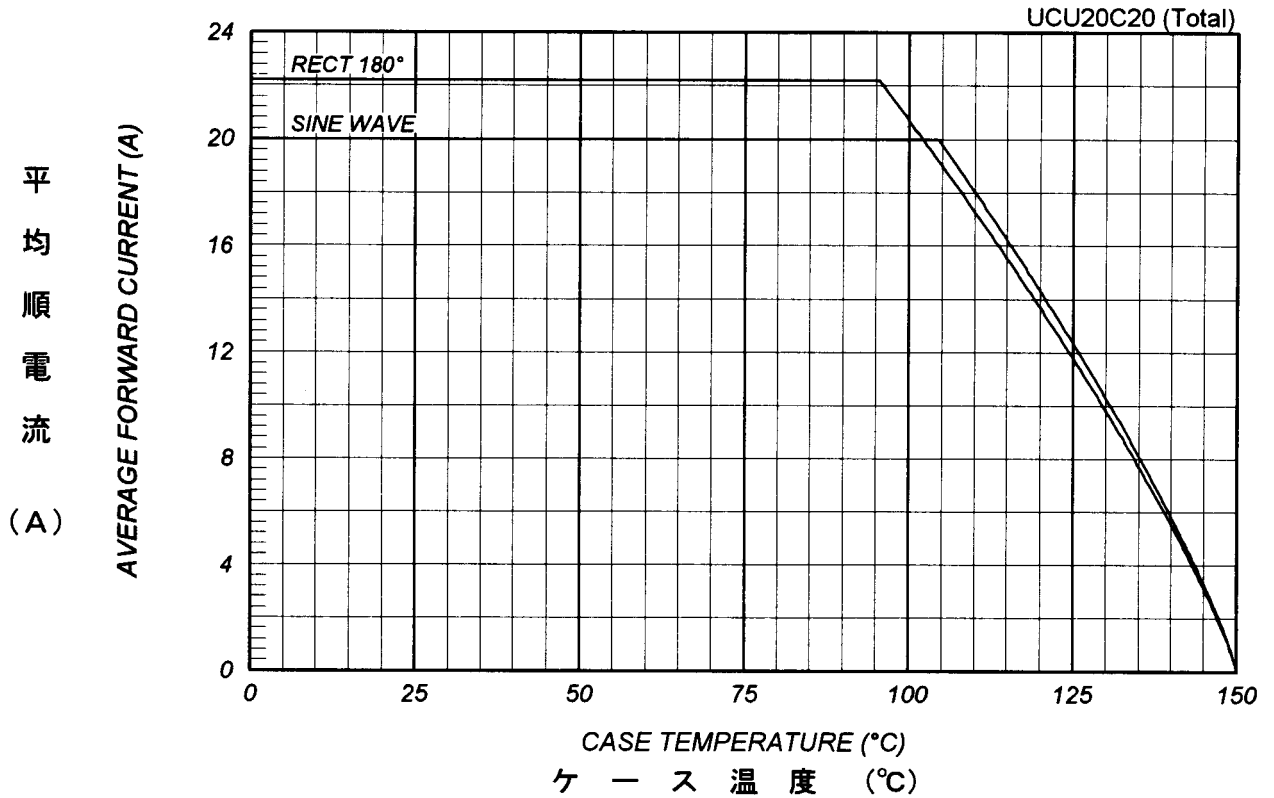

サージ順電流定格
SURGE CURRENT RATINGS

f=50Hz, Sine Wave, Non-Repetitive, No Load

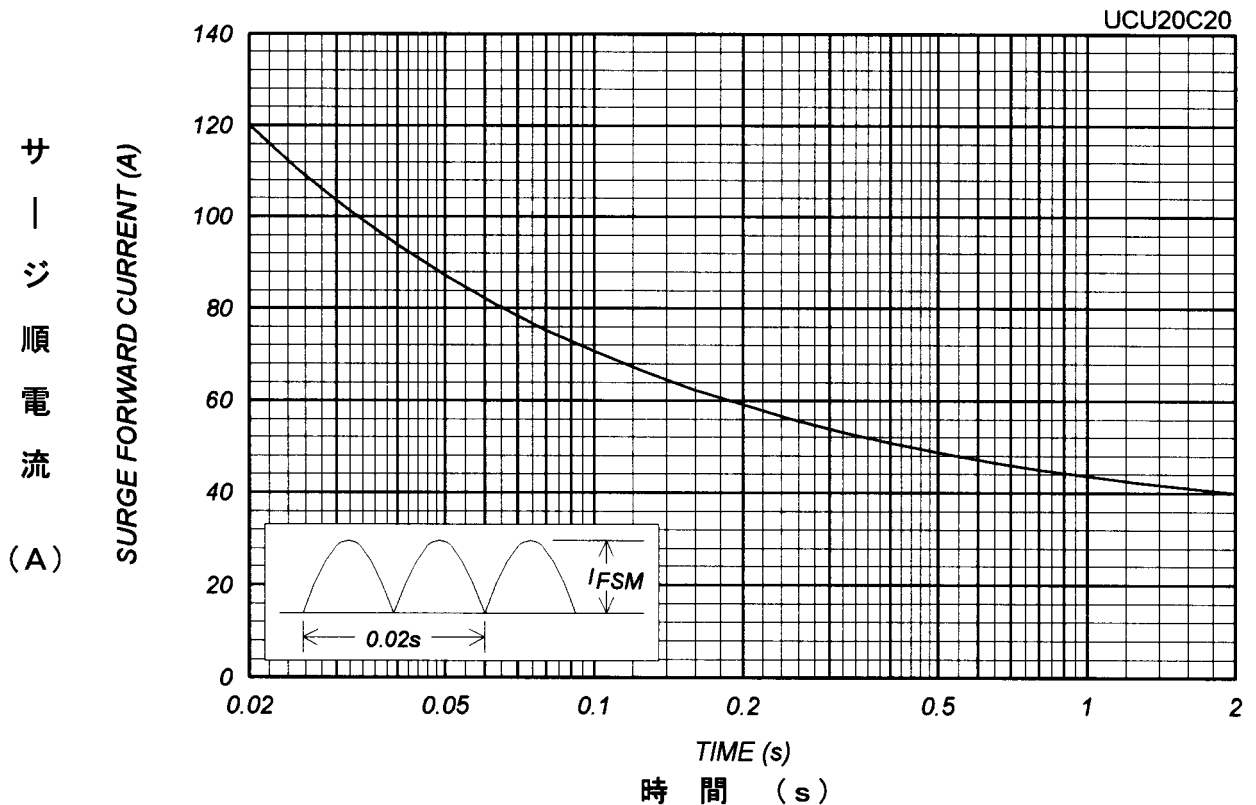

サージ実効順電流定格
RMS SURGE CURRENT RATINGS

Ta=40°C, Non-Repetitive, No Load

UCU20C20

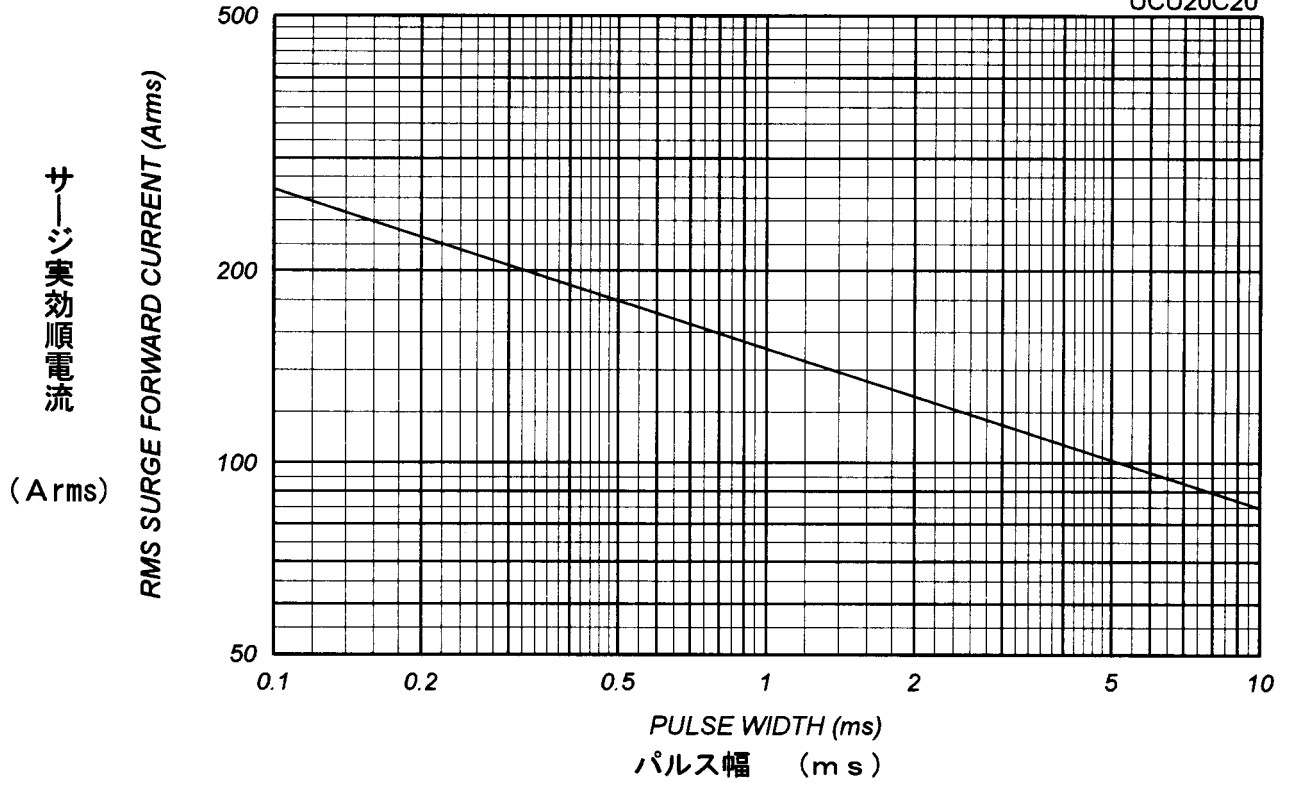

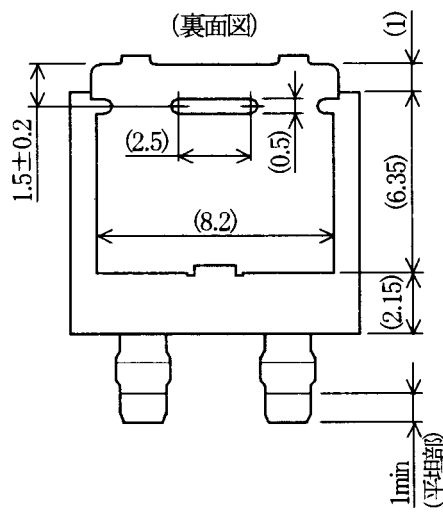
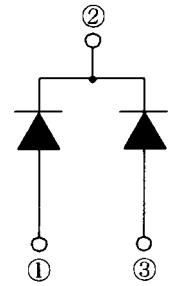
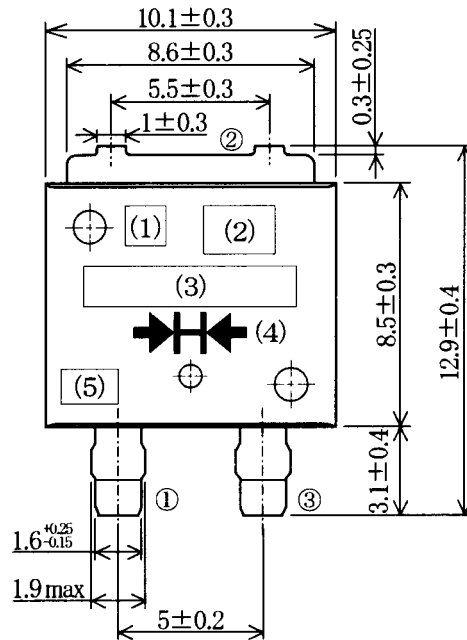
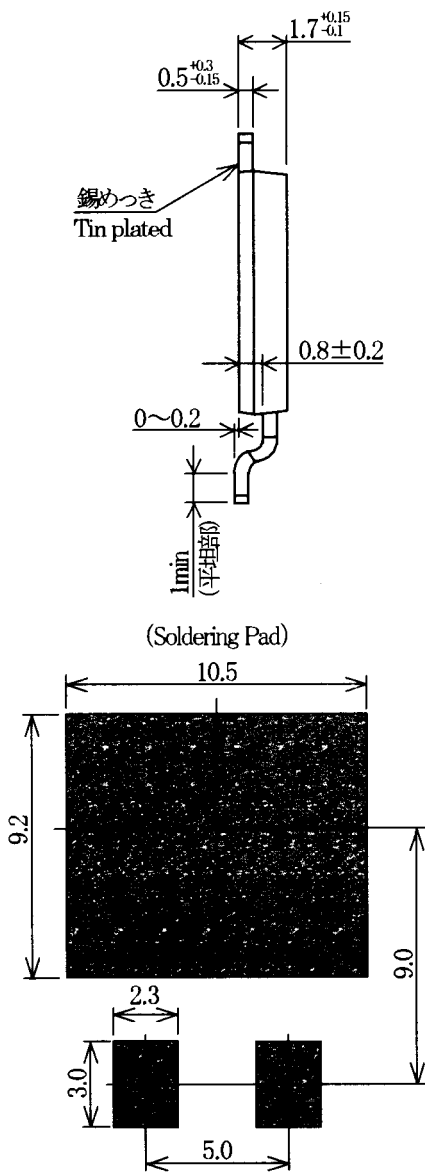

材料 Materials

- モールド材 Mold
エポキシ樹脂(UL94V-0認定品)
Epoxy Resin (UL94V-0 recognized)
- 外部リード Outer Lead
銅+錫めっき
Cu+Tin plated

質量 Weight : 0.59g

表示 Marking

- (1) 社名略マーク (N) Manufacturer's Mark (N)
- (2) ロット番号 Lot No.

製造年	西暦年代ノ下一桁ヲ表示スル												
製造月	月	1	2	3	4	5	6	7	8	9	10	11	12
	記号	A	B	C	D	E	F	G	H	I	J	K	L

(例) 2008年10月→8J

- (3) 型名 Type
UCU20C「」
- (4) 極性 Polarity
- (5) 管理記号 Identification code