

N AND P-CANNEL ENHANCEMENT MODE POWER MOSFET

PRODUCT SUMMARY

Simple Drive Requirement
Low Gate Charge
Fast Switching Performance

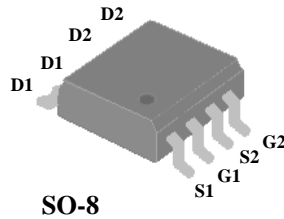

N-CH	BV_{DSS}	20V
	$R_{DS(ON)}$	18m Ω
	I_D	8.3A
P-CH	BV_{DSS}	-20V
	$R_{DS(ON)}$	45m Ω
	I_D	-5A

DESCRIPTION

The advanced power MOSFETs from Silicon Standard Corp. provide the designer with the best combination of fast switching, ruggedized device design, low on-resistance and cost-effectiveness.

The SO-8 package is widely preferred for commercial-industrial surface mount applications and suited for low voltage applications such as DC/DC converters.

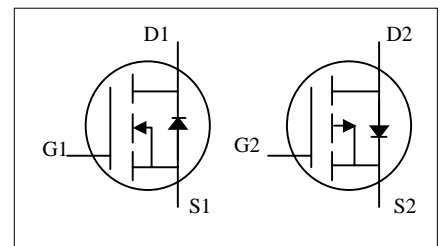

ABSOLUTE MAXIMUM RATINGS

Symbol	Parameter	Rating		Units
		N-channel	P-channel	
V_{DS}	Drain-Source Voltage	20	-20	V
V_{GS}	Gate-Source Voltage	± 12	± 12	V
$I_D@T_A=25^\circ C$	Continuous Drain Current ³	8.3	-5	A
$I_D@T_A=70^\circ C$	Continuous Drain Current ³	6.5	-4	A
I_{DM}	Pulsed Drain Current ¹	30	-20	A
$P_D@T_A=25^\circ C$	Total Power Dissipation	2.0		W
	Linear Derating Factor	0.016		W/ $^\circ C$
T_{STG}	Storage Temperature Range	-55 to 150		$^\circ C$
T_J	Operating Junction Temperature Range	-55 to 150		$^\circ C$

THERMAL DATA

Symbol	Parameter	Value	Unit
Rthj-a	Maximum Thermal Resistance, Junction-ambient ³	62.5	$^\circ C/W$

N-CH Electrical Characteristics @ $T_J=25^{\circ}\text{C}$ (unless otherwise specified)

Symbol	Parameter	Test Conditions	Min.	Typ.	Max.	Units
BV_{DSS}	Drain-Source Breakdown Voltage	$V_{GS}=0V, I_D=250\mu A$	20	-	-	V
$R_{DS(ON)}$	Static Drain-Source On-Resistance ²	$V_{GS}=10V, I_D=9A$	-	-	16	$m\Omega$
		$V_{GS}=4.5V, I_D=8.3A$	-	-	18	$m\Omega$
		$V_{GS}=2.5V, I_D=5.2A$	-	-	30	$m\Omega$
$V_{GS(th)}$	Gate Threshold Voltage	$V_{DS}=V_{GS}, I_D=250\mu A$	0.5	-	-	V
g_{fs}	Forward Transconductance	$V_{DS}=10V, I_D=8.3A$	-	8.3	-	S
I_{DSS}	Drain-Source Leakage Current ($T_J=25^{\circ}\text{C}$)	$V_{DS}=20V, V_{GS}=0V$	-	-	1	μA
	Drain-Source Leakage Current ($T_J=70^{\circ}\text{C}$)	$V_{DS}=16V, V_{GS}=0V$	-	-	25	μA
I_{GSS}	Gate-Source Leakage	$V_{GS}=\pm 12V$	-	-	± 100	nA
Q_g	Total Gate Charge ²	$I_D=8A$	-	22	-	nC
Q_{gs}	Gate-Source Charge	$V_{DS}=16V$	-	3	-	nC
Q_{gd}	Gate-Drain ("Miller") Charge	$V_{GS}=4.5V$	-	9	-	nC
$t_{d(on)}$	Turn-on Delay Time ²	$V_{DS}=10V$	-	11	-	ns
t_r	Rise Time	$I_D=1A$	-	13	-	ns
$t_{d(off)}$	Turn-off Delay Time	$R_G=3.3\Omega, V_{GS}=5V$	-	30	-	ns
t_f	Fall Time	$R_D=10\Omega$	-	14	-	ns
C_{iss}	Input Capacitance	$V_{GS}=0V$	-	1350	-	pF
C_{oss}	Output Capacitance	$V_{DS}=20V$	-	325	-	pF
C_{rss}	Reverse Transfer Capacitance	$f=1.0\text{MHz}$	-	255	-	pF

SOURCE-DRAIN DIODE

Symbol	Parameter	Test Conditions	Min.	Typ.	Max.	Units
V_{SD}	Forward On Voltage ²	$I_S=1.8A, V_{GS}=0V$	-	-	1.2	V
t_{rr}	Reverse Recovery Time ²	$I_S=8A, V_{GS}=0V,$	-	32	-	ns
Q_{rr}	Reverse Recovery Charge	$dI/dt=100A/\mu s$	-	24	-	nC

P-CH Electrical Characteristics @ $T_j=25^{\circ}\text{C}$ (unless otherwise specified)

Symbol	Parameter	Test Conditions	Min.	Typ.	Max.	Units
BV_{DSS}	Drain-Source Breakdown Voltage	$V_{GS}=0V, I_D=-250\mu A$	-20	-	-	V
$R_{DS(ON)}$	Static Drain-Source On-Resistance ²	$V_{GS}=-10V, I_D=-6A$	-	-	40	$m\Omega$
		$V_{GS}=-4.5V, I_D=-5A$	-	-	45	$m\Omega$
		$V_{GS}=-2.5V, I_D=-4A$	-	-	80	$m\Omega$
$V_{GS(th)}$	Gate Threshold Voltage	$V_{DS}=V_{GS}, I_D=-250\mu A$	-0.5	-	-	V
g_{fs}	Forward Transconductance	$V_{DS}=-10V, I_D=-2.2A$	-	2.2	-	S
I_{DSS}	Drain-Source Leakage Current ($T_j=25^{\circ}\text{C}$)	$V_{DS}=-20V, V_{GS}=0V$	-	-	-1	μA
	Drain-Source Leakage Current ($T_j=70^{\circ}\text{C}$)	$V_{DS}=-16V, V_{GS}=0V$	-	-	-25	μA
I_{GSS}	Gate-Source Leakage	$V_{GS}=\pm 12V$	-	-	± 100	nA
Q_g	Total Gate Charge ²	$I_D=-5A$	-	13	-	nC
Q_{gs}	Gate-Source Charge	$V_{DS}=-16V$	-	1.5	-	nC
Q_{gd}	Gate-Drain ("Miller") Charge	$V_{GS}=-4.5V$	-	4.5	-	nC
$t_{d(on)}$	Turn-on Delay Time ²	$V_{DS}=-10V$	-	8	-	ns
t_r	Rise Time	$I_D=-1A$	-	17	-	ns
$t_{d(off)}$	Turn-off Delay Time	$R_G=3.3\Omega, V_{GS}=-5V$	-	24	-	ns
t_f	Fall Time	$R_D=10\Omega$	-	36	-	ns
C_{iss}	Input Capacitance	$V_{GS}=0V$	-	920	-	pF
C_{oss}	Output Capacitance	$V_{DS}=-20V$	-	90	-	pF
C_{rss}	Reverse Transfer Capacitance	$f=1.0\text{MHz}$	-	85	-	pF

SOURCE-DRAIN DIODE

Symbol	Parameter	Test Conditions	Min.	Typ.	Max.	30
V_{SD}	Forward On Voltage ²	$I_S=-1.8A, V_{GS}=0V$	-	-	-1.2	V
t_{rr}	Reverse Recovery Time	$I_S=-5A, V_{GS}=0V,$	-	28	-	ns
Q_{rr}	Reverse Recovery Charge	$di/dt=100A/\mu s$	-	16	-	nC

Notes:

1. Pulse width limited by Max. junction temperature.
2. Pulse test
3. Surface mounted on 1 in² copper pad of FR4 board ; 135 °C/W when mounted on Min. copper pad.

THIS PRODUCT IS AN ELECTROSTATIC SENSITIVE, PLEASE HANDLE WITH CAUTION.

THIS PRODUCT HAS BEEN QUALIFIED FOR CONSUMER MARKET. APPLICATIONS OR USES AS CRITICAL COMPONENT IN LIFE SUPPORT DEVICE OR SYSTEM ARE NOT AUTHORIZED.

N-Channel

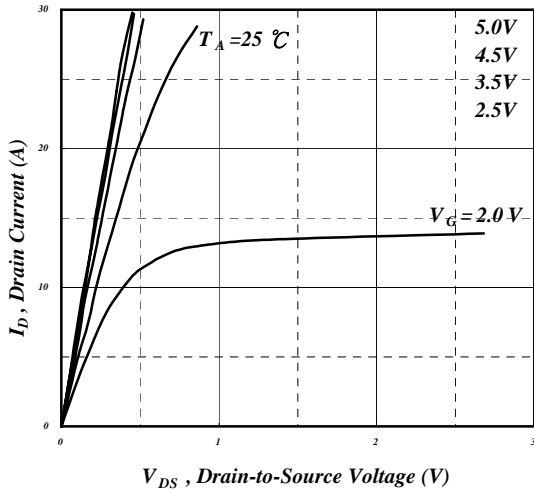

Fig 1. Typical Output Characteristics

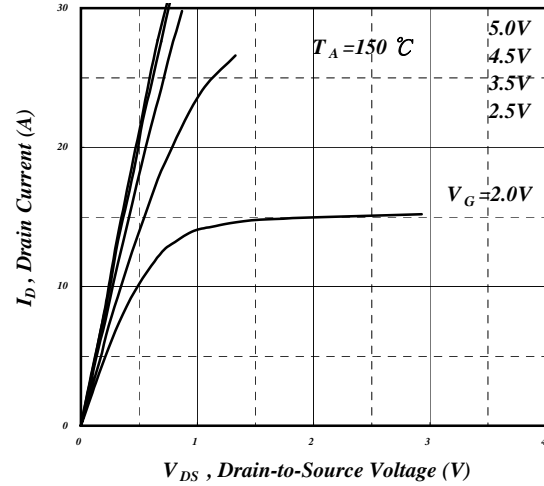

Fig 2. Typical Output Characteristics

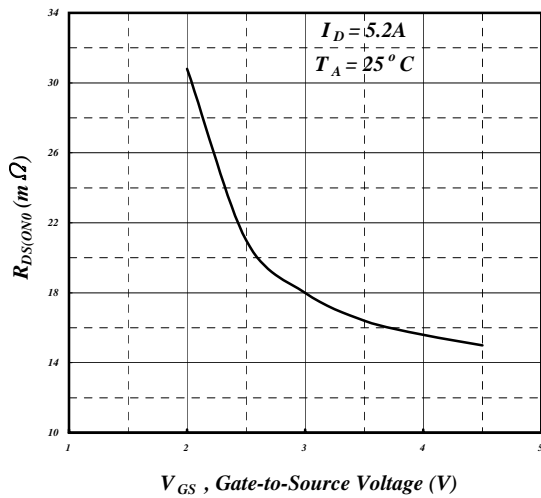

Fig 3. On-Resistance v.s. Gate Voltage

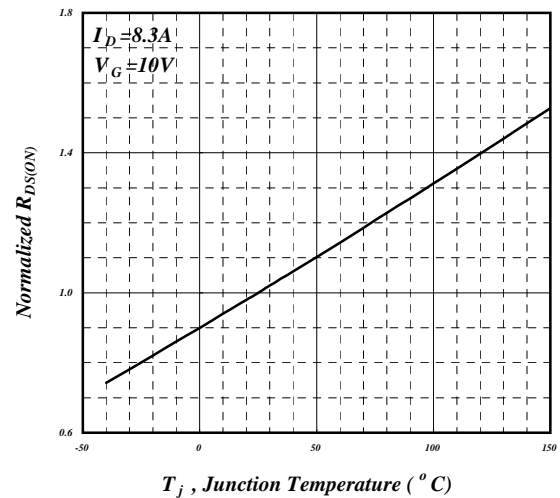

Fig 4. Normalized On-Resistance v.s. Junction Temperature

N-Channel

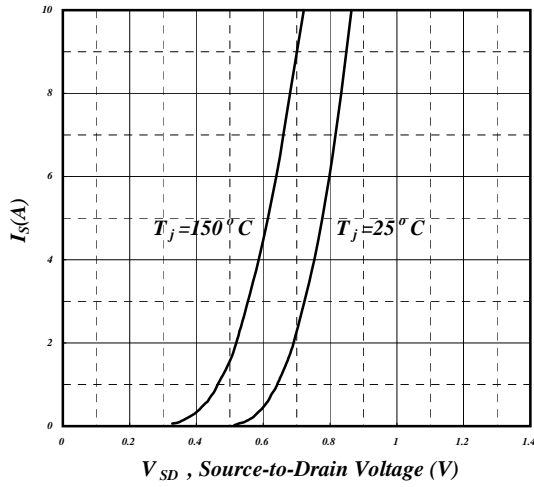

Fig 5. Forward Characteristic of Reverse Diode

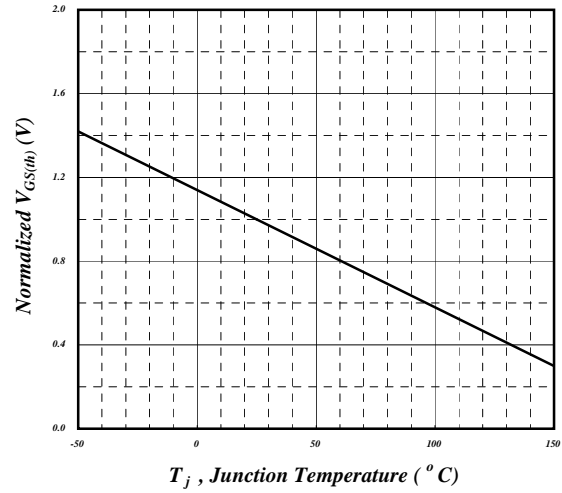

Fig 6. Gate Threshold Voltage v.s. Junction Temperature

N-Channel

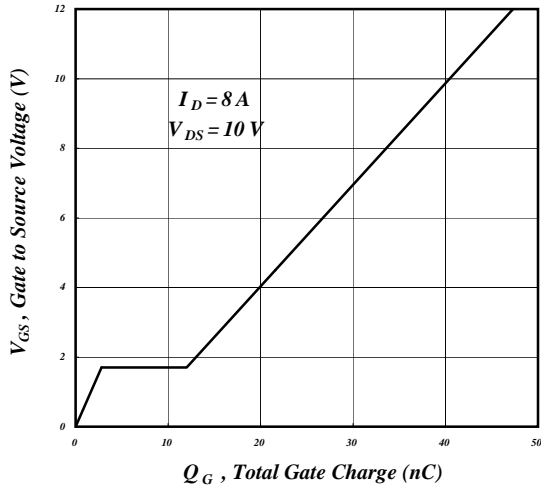

Fig 7. Gate Charge Characteristics

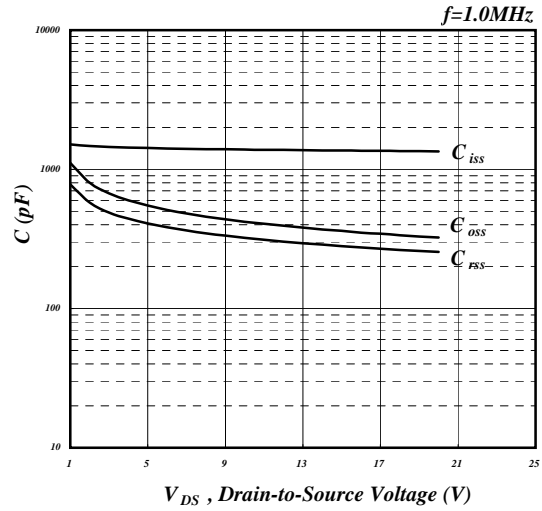

Fig 8. Typical Capacitance Characteristics

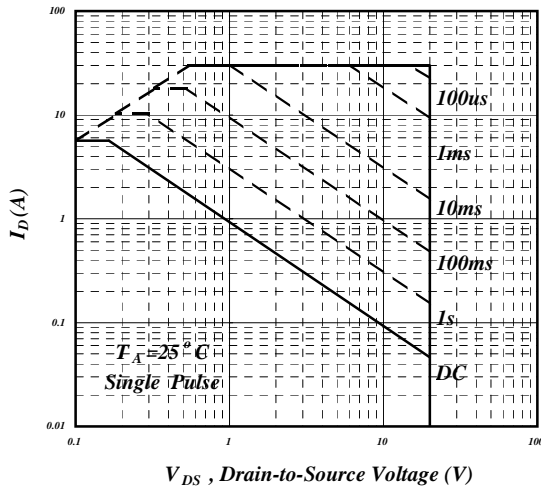

Fig 9. Maximum Safe Operating Area

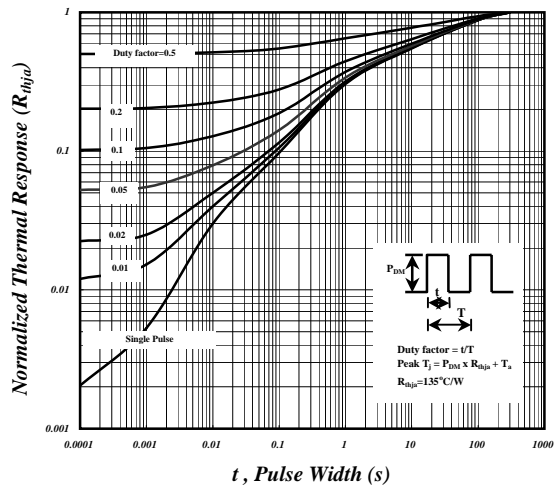

Fig 10. Effective Transient Thermal Impedance

N-Channel

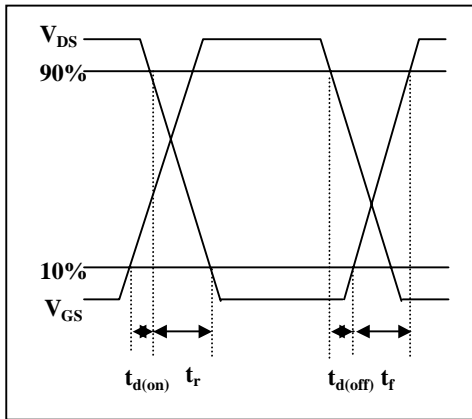

Fig 11. Switching Time Waveform

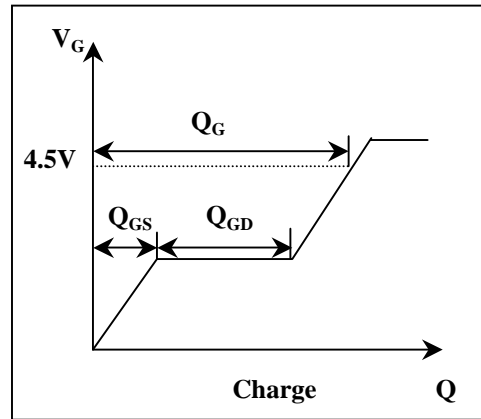

Fig 12. Gate Charge Waveform

P-Channel

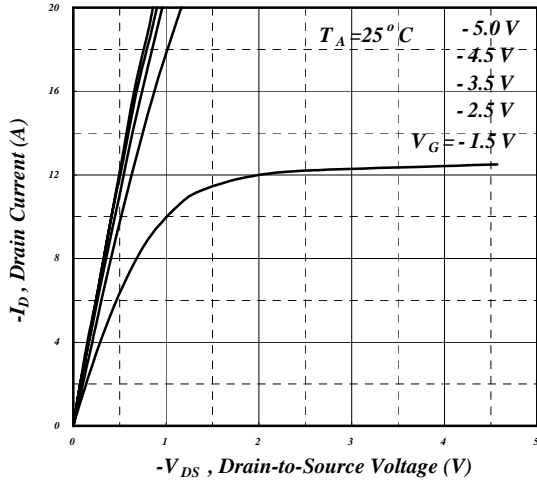

Fig 1. Typical Output Characteristics

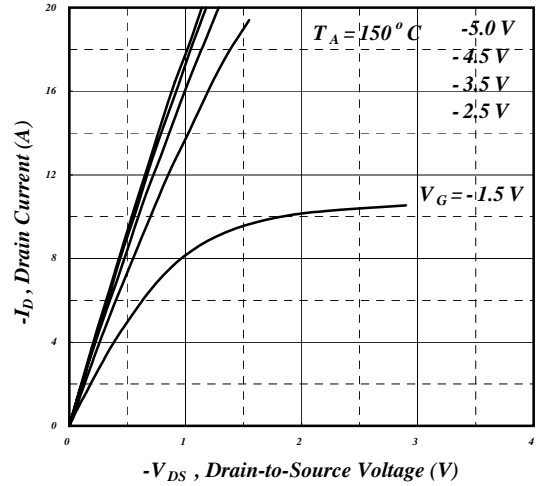

Fig 2. Typical Output Characteristics

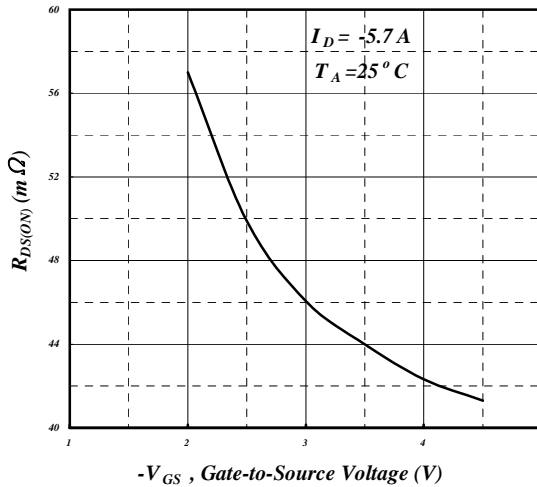

Fig 3. On-Resistance v.s. Gate Voltage

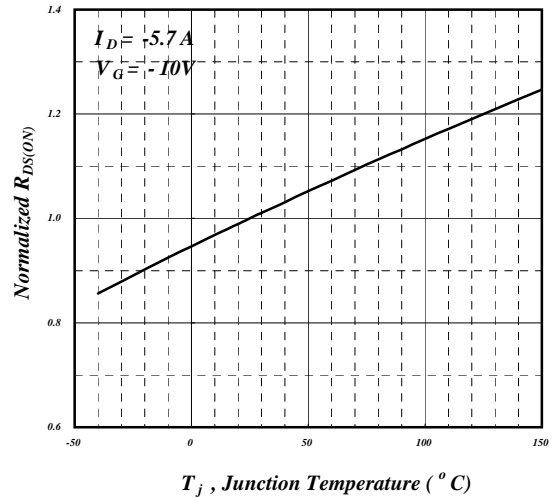

Fig 4. Normalized On-Resistance v.s. Junction Temperature

P-Channel

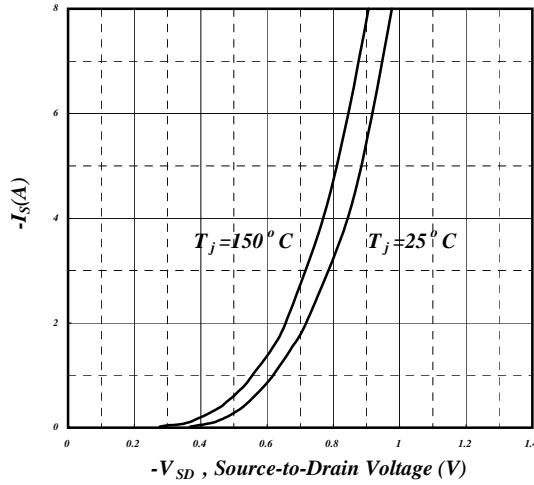

Fig 5. Forward Characteristic of Reverse Diode

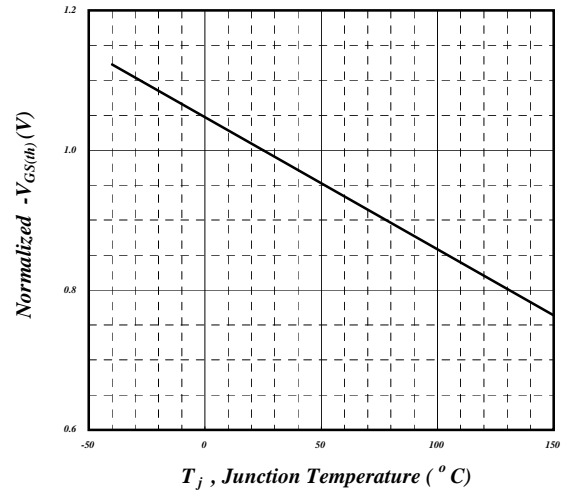

Fig 6. Gate Threshold Voltage v.s. Junction Temperature

P-Channel

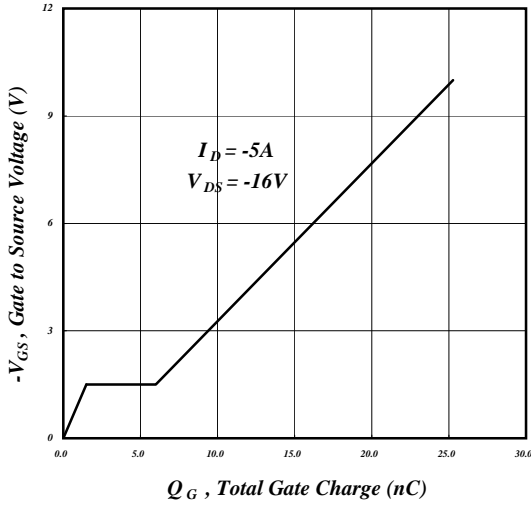

Fig 7. Gate Charge Characteristics

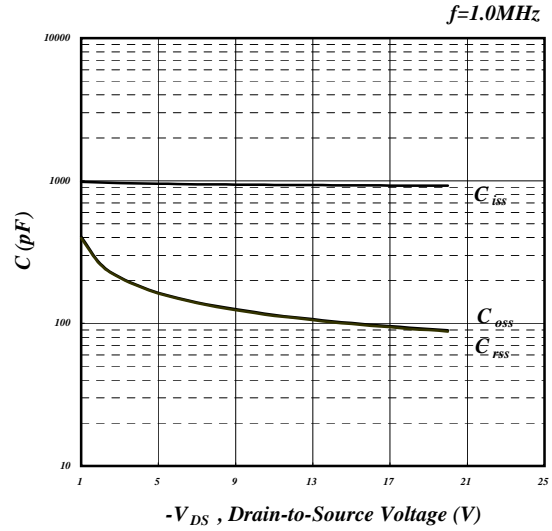

Fig 8. Typical Capacitance Characteristics

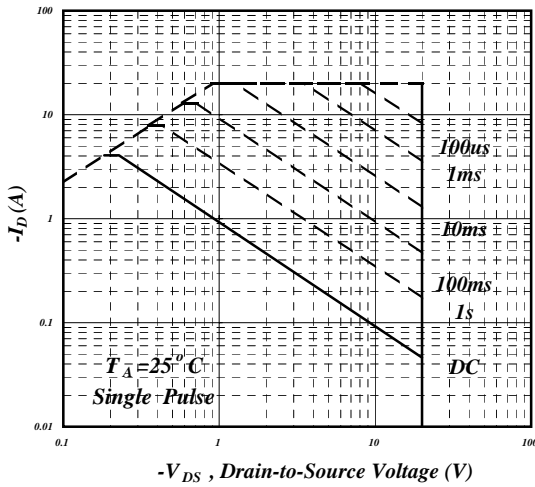

Fig 9. Maximum Safe Operating Area

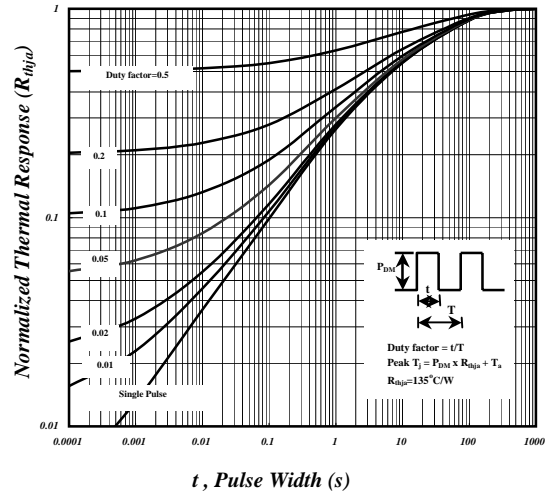

Fig 10. Effective Transient Thermal Impedance

P-Channel

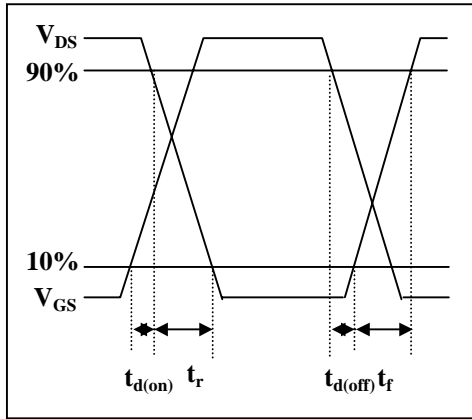

Fig 11. Switching Time Waveform

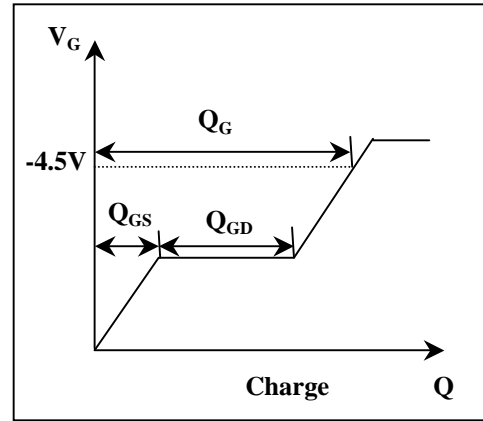
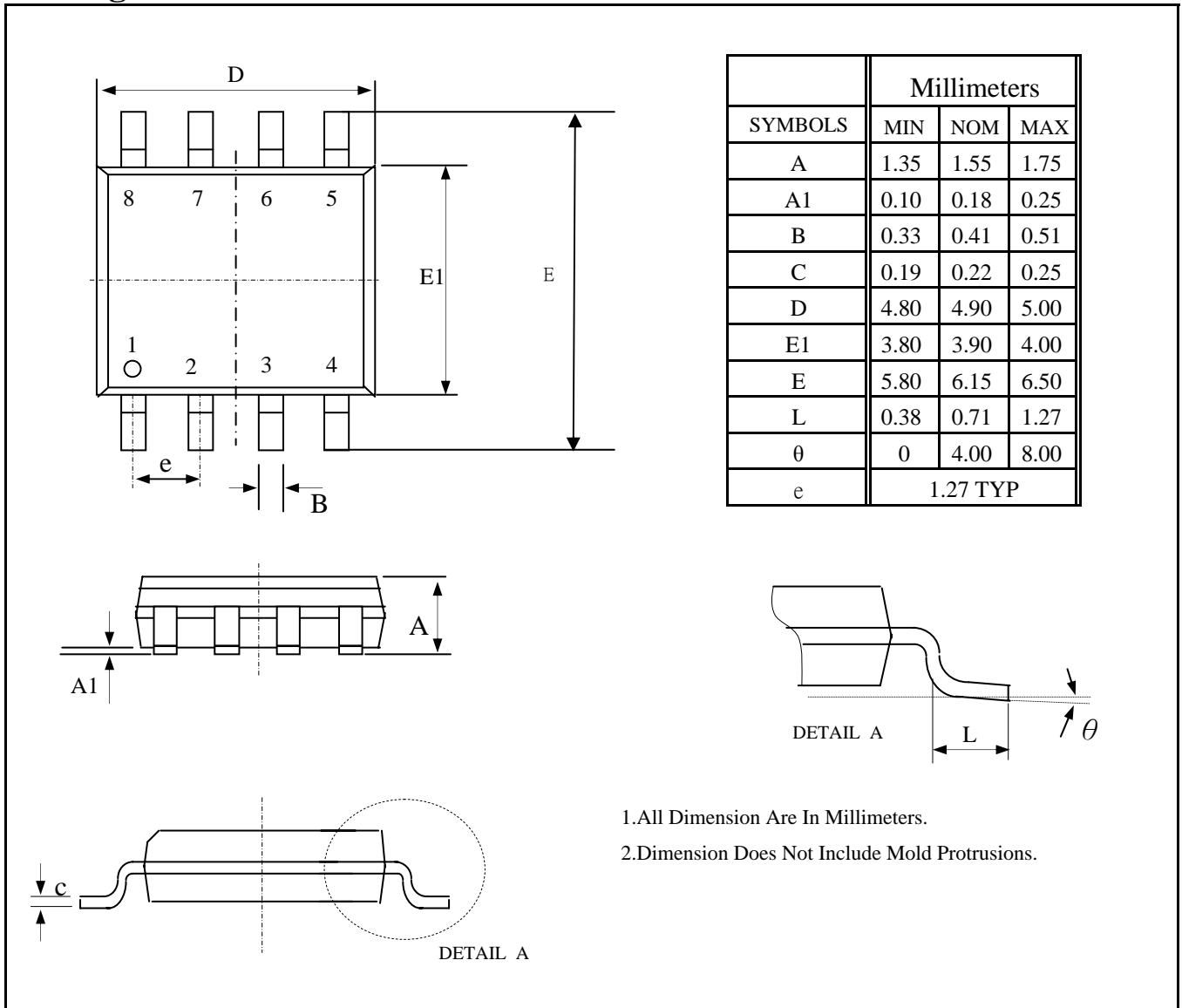

Fig 12. Gate Charge Waveform

Package Outline : SO-8



- 1.All Dimension Are In Millimeters.
- 2.Dimension Does Not Include Mold Protrusions.

Part Marking Information & Packing : SO-8

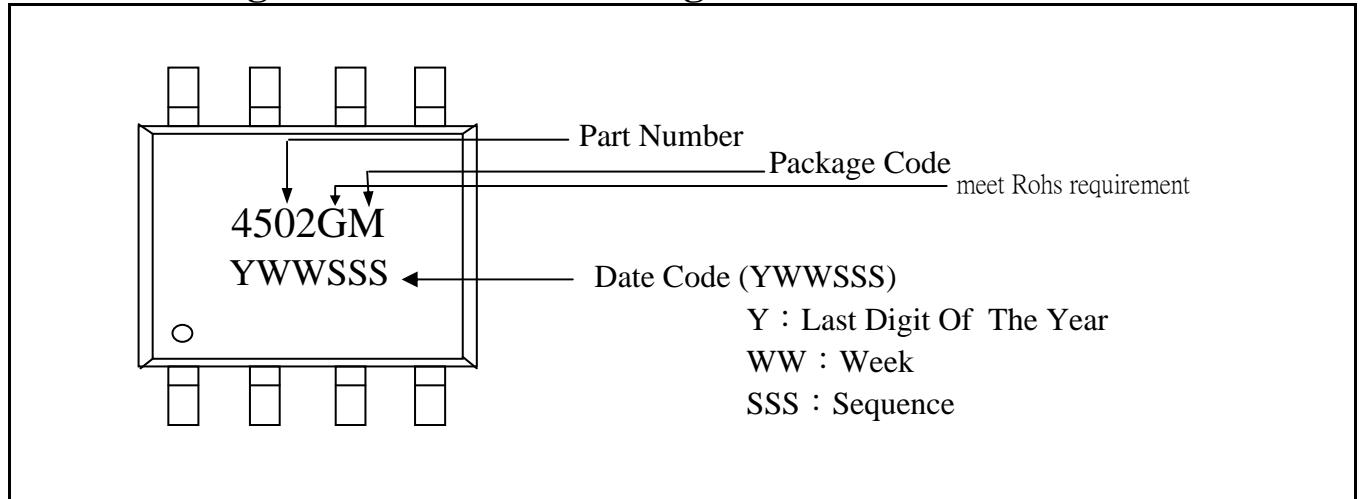

Information furnished by Silicon Standard Corporation is believed to be accurate and reliable. However, Silicon Standard Corporation makes no guarantee or warranty, expressed or implied, as to the reliability, accuracy, timeliness or completeness of such information and assumes no responsibility for its use, or for infringement of any patent or other intellectual property rights of third parties that may result from its use. Silicon Standard reserves the right to make changes as it deems necessary to any products described herein for any reason, including without limitation enhancement in reliability, functionality or design. No license is granted, whether expressly or by implication, in relation to the use of any products described herein or to the use of any information provided herein, under any patent or other intellectual property rights of Silicon Standard Corporation or any third parties.