

# P-channel Enhancement-mode Power MOSFET

## PRODUCT SUMMARY

$BV_{DSS}$	-40V
$R_{DS(ON)}$	28m $\Omega$
$I_D$	-7.3A

 **Pb-free; RoHS-compliant SO-8**

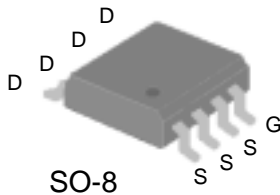

## DESCRIPTION

The SSM9564GM achieves fast switching performance with low gate charge without a complex drive circuit. It is suitable for low voltage applications such as DC/DC converters and general load-switching circuits.

The SSM9564GM is supplied in an RoHS-compliant SO-8 package, which is widely used for medium power commercial and industrial surface mount applications.

## ABSOLUTE MAXIMUM RATINGS

Symbol	Parameter	Value	Units
$V_{DS}$	Drain-source voltage	-40	V
$V_{GS}$	Gate-source voltage	$\pm 25$	V
$I_D$	Continuous drain current <sup>3</sup> , $T_C = 25^\circ\text{C}$	-7.3	A
		$T_C = 70^\circ\text{C}$	-5.9
$I_{DM}$	Pulsed drain current <sup>1</sup>	-30	A
$P_D$	Total power dissipation, $T_C = 25^\circ\text{C}$	2.5	W
	Linear derating factor	0.02	W/ $^\circ\text{C}$
$T_{STG}$	Storage temperature range	-55 to 150	$^\circ\text{C}$
$T_J$	Operating junction temperature range	-55 to 150	$^\circ\text{C}$

## THERMAL CHARACTERISTICS

Symbol	Parameter	Value	Units
$R_{\theta JA}$	Maximum thermal resistance, junction-ambient <sup>3</sup>	50	$^\circ\text{C}/\text{W}$

### Notes:

1. Pulse width must be limited to avoid exceeding the maximum junction temperature of 150 $^\circ\text{C}$ .
2. Pulse width <300us, duty cycle <2%.
3. Mounted on a square inch of copper pad on FR4 board; 125 $^\circ\text{C}/\text{W}$  when mounted on the minimum pad area required for soldering.

**ELECTRICAL CHARACTERISTICS** (at  $T_j = 25^\circ\text{C}$ , unless otherwise specified)

Symbol	Parameter	Test Conditions	Min.	Typ.	Max.	Units
$BV_{DSS}$	Drain-source breakdown voltage	$V_{GS}=0V, I_D=-250\mu A$	-40	-	-	V
$\Delta BV_{DSS}/\Delta T_j$	Breakdown voltage temperature coefficient	Reference to $25^\circ\text{C}$ , $I_D=-1\text{mA}$	-	-0.03	-	$V/^\circ\text{C}$
$R_{DS(ON)}$	Static drain-source on-resistance <sup>2</sup>	$V_{GS}=-10V, I_D=-7A$	-	-	28	$m\Omega$
		$V_{GS}=-4.5V, I_D=-5A$	-	-	40	$m\Omega$
$V_{GS(th)}$	Gate threshold voltage	$V_{DS}=V_{GS}, I_D=-250\mu A$	-1	-	-3	V
$g_{fs}$	Forward transconductance	$V_{DS}=-10V, I_D=-7A$	-	13	-	S
$I_{DSS}$	Drain-source leakage current	$V_{DS}=-40V, V_{GS}=0V, T_j = 25^\circ\text{C}$	-	-	-1	$\mu A$
		$V_{DS}=-32V, V_{GS}=0V, T_j = 70^\circ\text{C}$	-	-	-25	$\mu A$
$I_{GSS}$	Gate-source leakage current	$V_{GS}=\pm 25V$	-	-	$\pm 100$	nA
$Q_g$	Total gate charge <sup>2</sup>	$I_D=-7A$	-	27	43	nC
$Q_{gs}$	Gate-source charge	$V_{DS}=-32V$	-	6	-	nC
$Q_{gd}$	Gate-drain ("Miller") charge	$V_{GS}=-4.5V$	-	14	-	nC
$t_{d(on)}$	Turn-on delay time <sup>2</sup>	$V_{DS}=-20V$	-	14	-	ns
$t_r$	Rise time	$I_D=-1A$	-	8	-	ns
$t_{d(off)}$	Turn-off delay time	$R_G=3.3\Omega, V_{GS}=-10V$	-	46	-	ns
$t_f$	Fall time	$R_D=20\Omega$	-	17	-	ns
$C_{iss}$	Input capacitance	$V_{GS}=0V$	-	2240	3600	pF
$C_{oss}$	Output capacitance	$V_{DS}=-25V$	-	300	-	pF
$C_{rss}$	Reverse transfer capacitance	$f=1.0\text{MHz}$	-	250	-	pF

**Source-Drain Diode**

Symbol	Parameter	Test Conditions	Min.	Typ.	Max.	Units
$V_{SD}$	Forward voltage <sup>2</sup>	$I_S=-2A, V_{GS}=0V$	-	-	-1.2	V
$t_{rr}$	Reverse-recovery time <sup>2</sup>	$I_S=-7A, V_{GS}=0V,$	-	37	-	ns
$Q_{rr}$	Reverse-recovery charge	$di/dt=100A/\mu s$	-	57	-	nC

**Notes:**

1. Pulse width must be limited to avoid exceeding the maximum junction temperature of  $150^\circ\text{C}$ .

2. Pulse width  $<300\mu s$ , duty cycle  $<2\%$ .

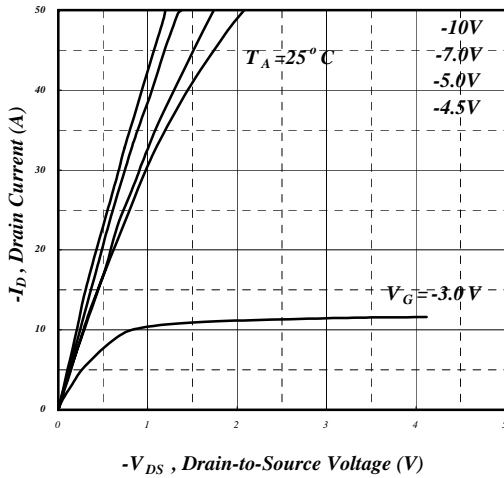

Fig 1. Typical Output Characteristics

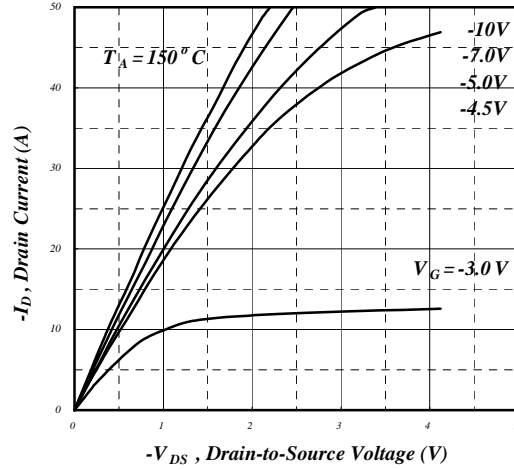

Fig 2. Typical Output Characteristics

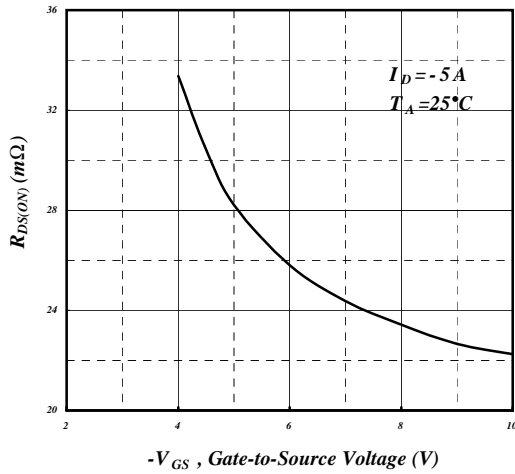

Fig 3. On-Resistance vs. Gate Voltage

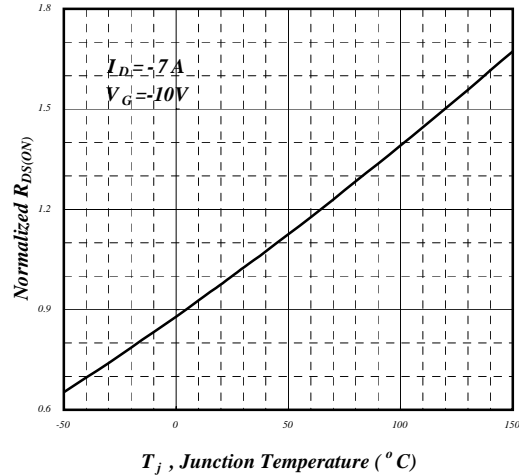

Fig 4. Normalized On-Resistance vs. Junction Temperature

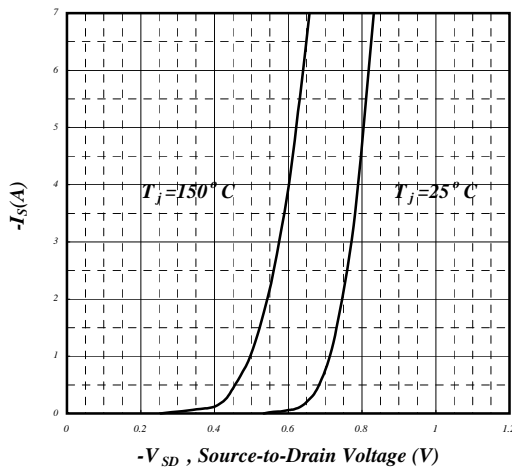

Fig 5. Forward Characteristic of Reverse Diode

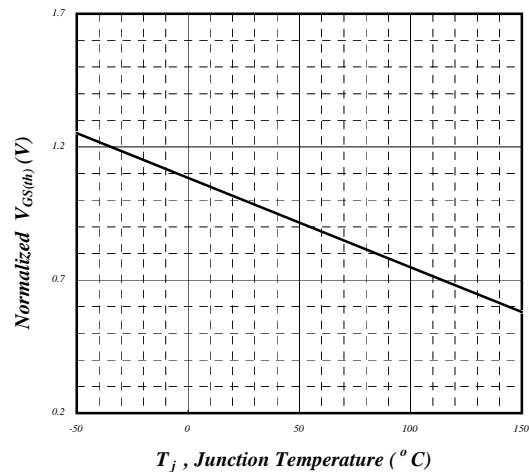

Fig 6. Gate Threshold Voltage vs. Junction Temperature

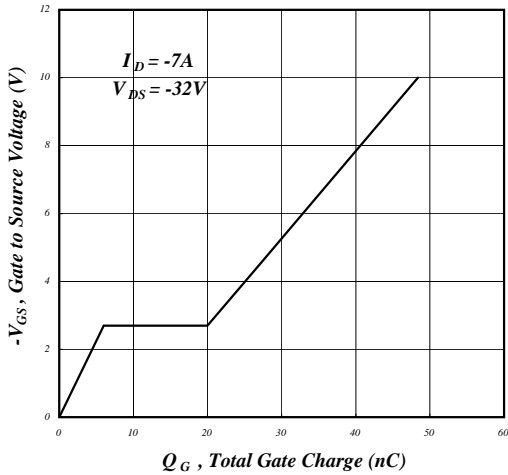

Fig 7. Gate Charge Characteristics

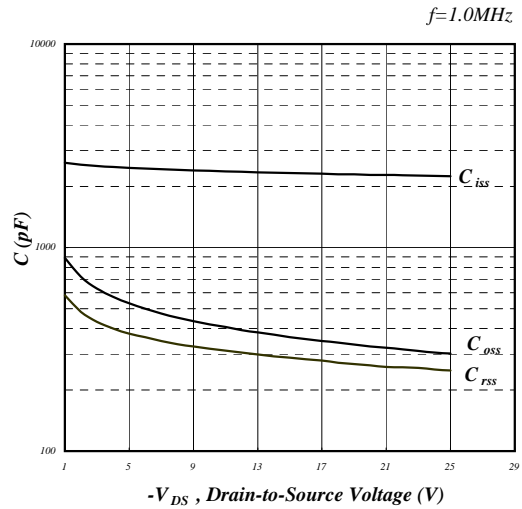

Fig 8. Typical Capacitance Characteristics

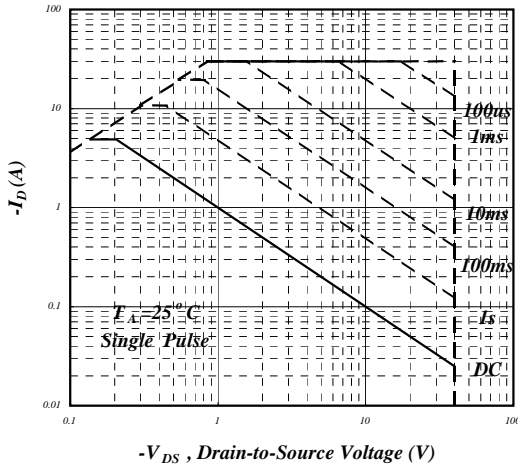

Fig 9. Maximum Safe Operating Area

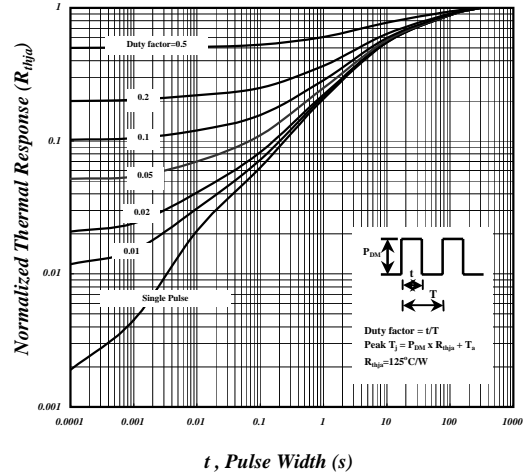

Fig 10. Effective Transient Thermal Impedance

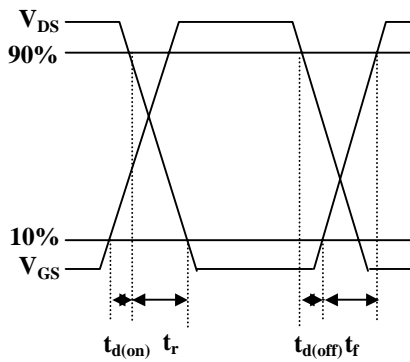

Fig 11. Switching Time Waveform

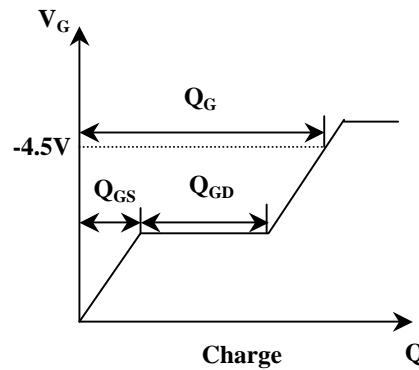
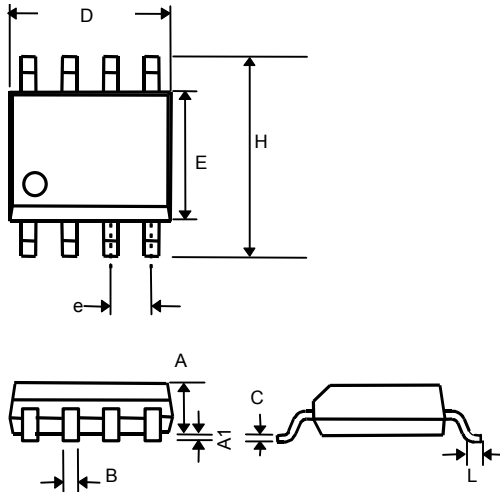

Fig 12. Gate Charge Waveform

## PHYSICAL DIMENSIONS



SYMBOL	MIN	MAX
A	1.35	1.75
A1	0.10	0.25
B	0.33	0.51
C	0.19	0.25
D	4.80	5.00
E	3.80	4.00
e	1.27(TYP)	
H	5.80	6.50
L	0.38	1.27

All dimensions in millimeters.  
Dimensions do not include mold protrusions.

## PART MARKING

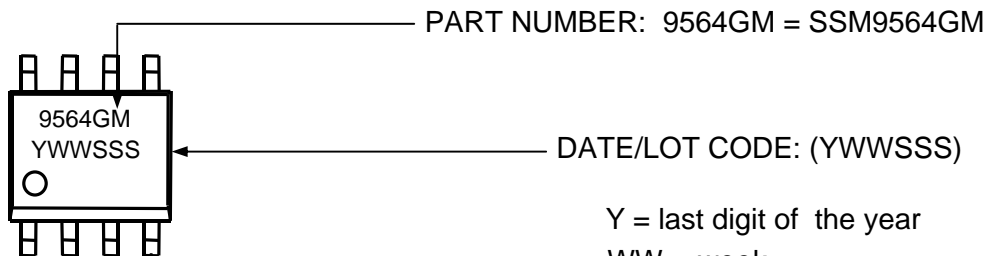

Y = last digit of the year  
WW = week  
SSS = lot code sequence

## PACKING: Moisture sensitivity level MSL3

3000 pcs in antistatic tape on a 13 inch (330mm) reel packed in a moisture barrier bag (MBB).

Information furnished by Silicon Standard Corporation is believed to be accurate and reliable. However, Silicon Standard Corporation makes no guarantee or warranty, expressed or implied, as to the reliability, accuracy, timeliness or completeness of such information and assumes no responsibility for its use, or for infringement of any patent or other intellectual property rights of third parties that may result from its use. Silicon Standard reserves the right to make changes as it deems necessary to any products described herein for any reason, including without limitation enhancement in reliability, functionality or design. No license is granted, whether expressly or by implication, in relation to the use of any products described herein or to the use of any information provided herein, under any patent or other intellectual property rights of Silicon Standard Corporation or any third parties.