

P-channel Enhancement-mode Power MOSFET

PRODUCT SUMMARY

BV_{DSS}	-40V
$R_{DS(ON)}$	40m Ω
I_D	-6A

 **Pb-free; RoHS-compliant SO-8**

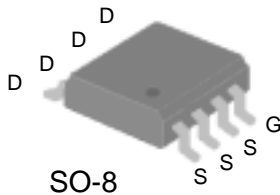

DESCRIPTION

The SSM9563GM achieves fast switching performance with low gate charge without a complex drive circuit. It is suitable for low voltage applications such as DC/DC converters and general load-switching circuits.

The SSM9563GM is supplied in an RoHS-compliant SO-8 package, which is widely used for medium power commercial and industrial surface mount applications.

ABSOLUTE MAXIMUM RATINGS

Symbol	Parameter	Value	Units
V_{DS}	Drain-source voltage	-40	V
V_{GS}	Gate-source voltage	± 25	V
I_D	Continuous drain current ³ , $T_C = 25^\circ\text{C}$	-6	A
		$T_C = 70^\circ\text{C}$	-4.8
I_{DM}	Pulsed drain current ¹	-30	A
P_D	Total power dissipation, $T_C = 25^\circ\text{C}$	2.5	W
	Linear derating factor	0.02	W/ $^\circ\text{C}$
T_{STG}	Storage temperature range	-55 to 150	$^\circ\text{C}$
T_J	Operating junction temperature range	-55 to 150	$^\circ\text{C}$

THERMAL CHARACTERISTICS

Symbol	Parameter	Value	Units
$R_{\theta JA}$	Maximum thermal resistance, junction-ambient ³	50	$^\circ\text{C}/\text{W}$

Notes:

1. Pulse width must be limited to avoid exceeding the maximum junction temperature of 150 $^\circ\text{C}$.
2. Pulse width <300us, duty cycle <2%.
3. Mounted on a square inch of copper pad on FR4 board; 125 $^\circ\text{C}/\text{W}$ when mounted on the minimum pad area required for soldering.

ELECTRICAL CHARACTERISTICS (at $T_j = 25^\circ\text{C}$, unless otherwise specified)

Symbol	Parameter	Test Conditions	Min.	Typ.	Max.	Units
BV_{DSS}	Drain-source breakdown voltage	$V_{GS}=0V, I_D=-250\mu A$	-40	-	-	V
$\Delta BV_{DSS}/\Delta T_j$	Breakdown voltage temperature coefficient	Reference to 25°C , $I_D=-1\text{mA}$	-	-0.03	-	$V/^\circ\text{C}$
$R_{DS(ON)}$	Static drain-source on-resistance ²	$V_{GS}=-10V, I_D=-6A$	-	-	40	$m\Omega$
		$V_{GS}=-4.5V, I_D=-4A$	-	-	60	$m\Omega$
$V_{GS(th)}$	Gate threshold voltage	$V_{DS}=V_{GS}, I_D=-250\mu A$	-1	-	-3	V
g_{fs}	Forward transconductance	$V_{DS}=-10V, I_D=-6A$	-	10	-	S
I_{DSS}	Drain-source leakage current	$V_{DS}=-40V, V_{GS}=0V, T_j = 25^\circ\text{C}$	-	-	-1	μA
		$V_{DS}=-32V, V_{GS}=0V, T_j = 70^\circ\text{C}$	-	-	-25	μA
I_{GSS}	Gate-source leakage current	$V_{GS}=\pm 25V$	-	-	± 100	nA
Q_g	Total gate charge ²	$I_D=-6A$	-	19	30	nC
Q_{gs}	Gate-source charge	$V_{DS}=-32V$	-	5	-	nC
Q_{gd}	Gate-drain ("Miller") charge	$V_{GS}=-4.5V$	-	8	-	nC
$t_{d(on)}$	Turn-on delay time ²	$V_{DS}=-20V$	-	12	-	ns
t_r	Rise time	$I_D=-1A$	-	7	-	ns
$t_{d(off)}$	Turn-off delay time	$R_G=3.3\Omega, V_{GS}=-10V$	-	68	-	ns
t_f	Fall time	$R_D=20\Omega$	-	38	-	ns
C_{iss}	Input capacitance	$V_{GS}=0V$	-	1600	2560	pF
C_{oss}	Output capacitance	$V_{DS}=-25V$	-	240	-	pF
C_{rss}	Reverse transfer capacitance	$f=1.0\text{MHz}$	-	190	-	pF

Source-Drain Diode

Symbol	Parameter	Test Conditions	Min.	Typ.	Max.	Units
V_{SD}	Forward voltage ²	$I_S=-2A, V_{GS}=0V$	-	-	-1.2	V
t_{rr}	Reverse-recovery time ²	$I_S=-6A, V_{GS}=0V,$	-	37	-	ns
Q_{rr}	Reverse-recovery charge	$di/dt=100A/\mu s$	-	54	-	nC

Notes:

1. Pulse width must be limited to avoid exceeding the maximum junction temperature of 150°C .

2. Pulse width $<300\mu s$, duty cycle $<2\%$.

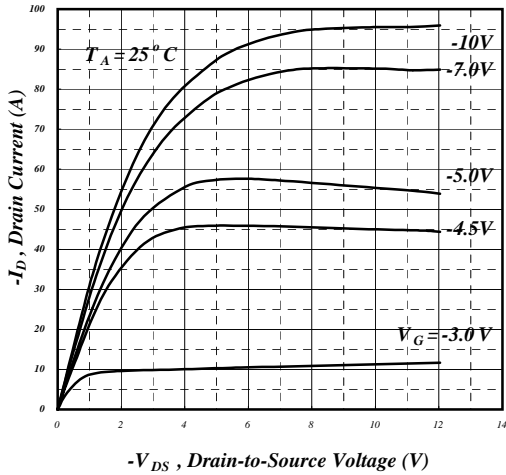

Fig 1. Typical Output Characteristics

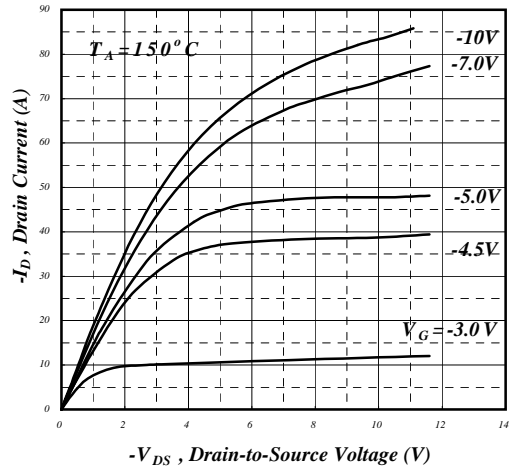

Fig 2. Typical Output Characteristics

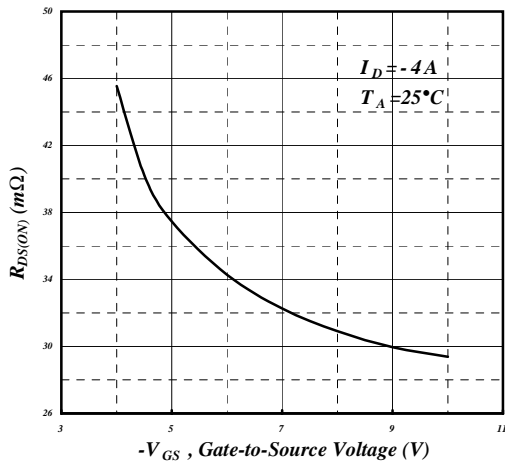

Fig 3. On-Resistance vs. Gate Voltage

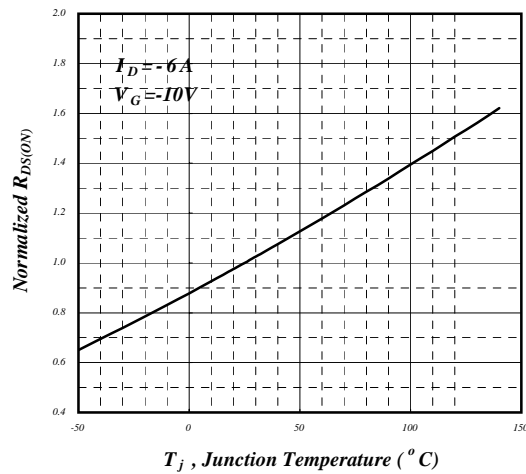

Fig 4. Normalized On-Resistance vs. Junction Temperature

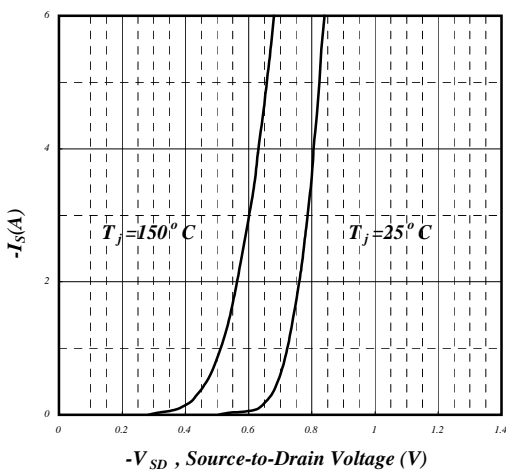

Fig 5. Forward Characteristic of Reverse Diode

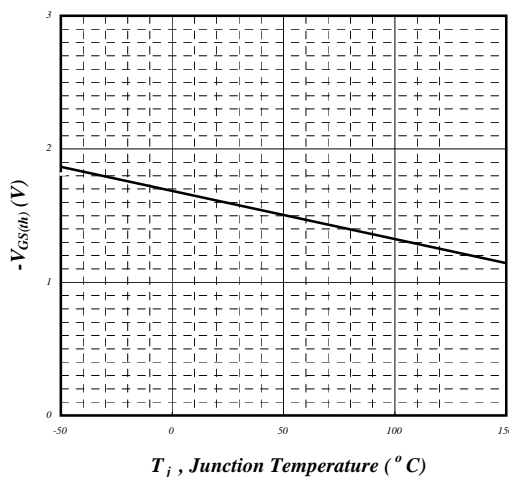

Fig 6. Gate Threshold Voltage vs. Junction Temperature

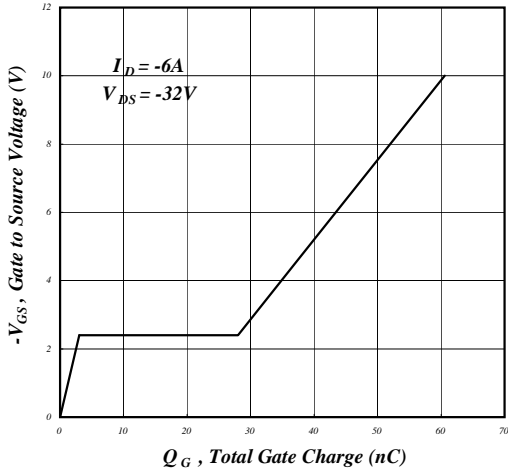

Fig 7. Gate Charge Characteristics

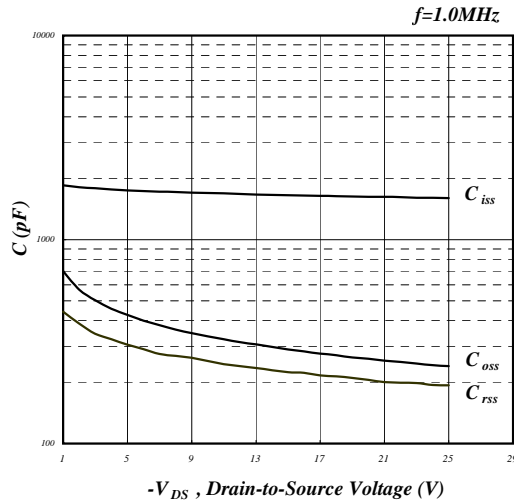

Fig 8. Typical Capacitance Characteristics

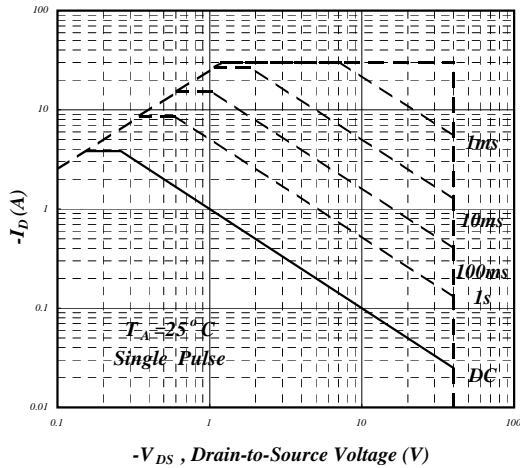

Fig 9. Maximum Safe Operating Area

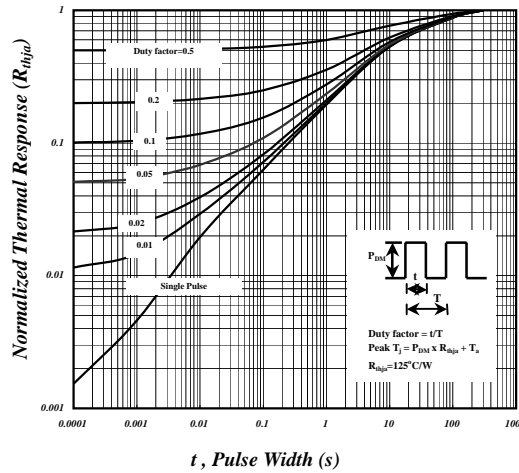

Fig 10. Effective Transient Thermal Impedance

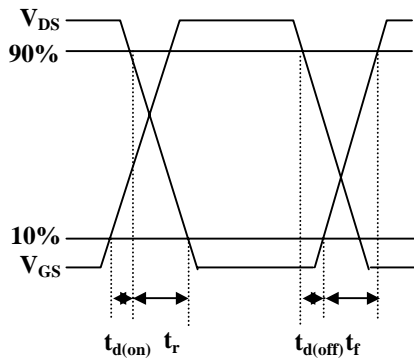

Fig 11. Switching Time Waveform

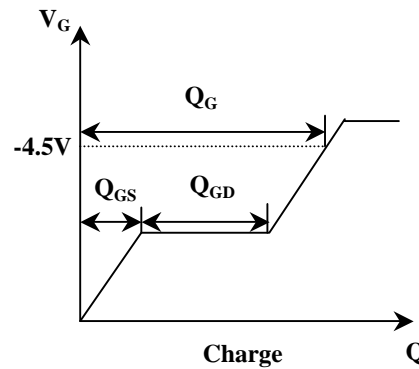
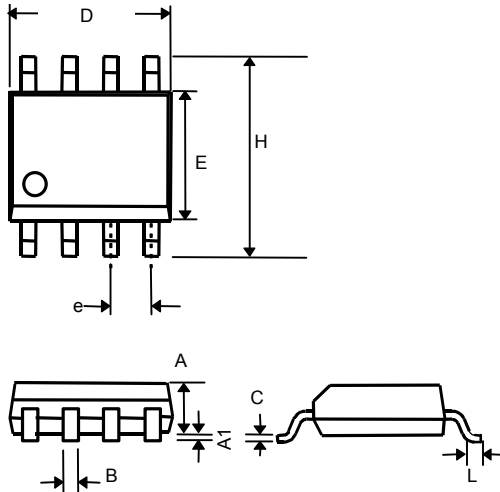

Fig 12. Gate Charge Waveform

PHYSICAL DIMENSIONS



SYMBOL	MIN	MAX
A	1.35	1.75
A1	0.10	0.25
B	0.33	0.51
C	0.19	0.25
D	4.80	5.00
E	3.80	4.00
e	1.27(TYP)	
H	5.80	6.50
L	0.38	1.27

All dimensions in millimeters.
Dimensions do not include mold protrusions.

PART MARKING

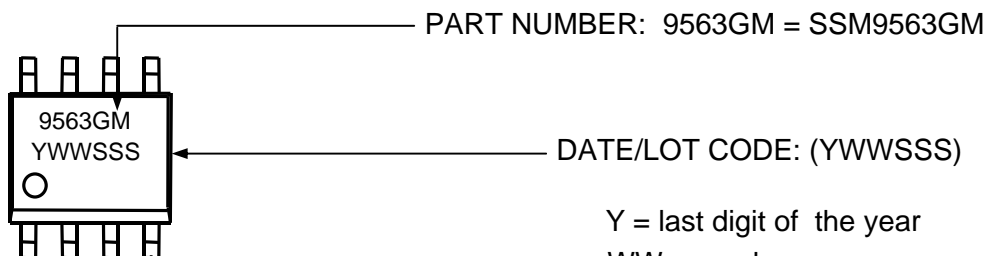

Y = last digit of the year
WW = week
SSS = lot code sequence

PACKING: Moisture sensitivity level MSL3

3000 pcs in antistatic tape on a 13 inch (330mm) reel packed in a moisture barrier bag (MBB).

Information furnished by Silicon Standard Corporation is believed to be accurate and reliable. However, Silicon Standard Corporation makes no guarantee or warranty, expressed or implied, as to the reliability, accuracy, timeliness or completeness of such information and assumes no responsibility for its use, or for infringement of any patent or other intellectual property rights of third parties that may result from its use. Silicon Standard reserves the right to make changes as it deems necessary to any products described herein for any reason, including without limitation enhancement in reliability, functionality or design. No license is granted, whether expressly or by implication, in relation to the use of any products described herein or to the use of any information provided herein, under any patent or other intellectual property rights of Silicon Standard Corporation or any third parties.