

DIGITRON SEMICONDUCTORS

MUR5150E

5A SCHOTTKY RECTIFIER

MAXIMUM RATINGS

Rating	Symbol	MUR5150E	Unit
Peak repetitive reverse voltage	V_{RRM}	1500	V
Working peak reverse voltage	V_{RWM}		
DC blocking voltage	V_R		
Average rectified forward current (Rated V_R)	$I_{F(AV)}$	5.0 @ $T_C = 100^\circ\text{C}$	A
Peak repetitive forward current (Rated V_R , square wave, 20 kHz)	I_{FRM}	10	A
Non-repetitive peak surge current (surge applied at rated load conditions, halfwave, single phase, 60Hz)	I_{FSM}	100	A
Operating and storage junction temperature range	T_J, T_{stg}	-65 to +125	$^\circ\text{C}$
Controlled avalanche energy	W_{AVL}	20	mJ
Maximum thermal resistance Junction to case	$R_{\theta JC}$	2.0	$^\circ\text{C}/\text{W}$

ELECTRICAL CHARACTERISTICS ($T_C = 25^\circ\text{C}$ unless otherwise noted)

Parameter	Symbol	MUR5150E	Unit
Maximum instantaneous forward voltage ⁽¹⁾ ($I_F = 2.0\text{A}, T_C = 25^\circ\text{C}$) ($I_F = 5.0\text{A}, T_C = 25^\circ\text{C}$)	V_F	2.0 2.4	V
Maximum instantaneous reverse current ⁽¹⁾ (Rated dc voltage, $T_C = 125^\circ\text{C}$) (Rated dc voltage, $T_C = 25^\circ\text{C}$)	I_R	500 50	μA
Maximum reverse recovery time ($I_F = 1.0\text{A}, di/dt = 50\text{A}/\mu\text{s}$)	t_{rr}	175	ns
Maximum forward recovery time ($I_F = 6.5\text{A}, di/dt = 12\text{A}/\mu\text{s}$)	t_{fr}	225	ns
Peak transient overshoot voltage	V_{RFM}	20	V

Note 1: Pulse test: Pulse width = 300 μs , duty cycle $\leq 2.0\%$.

MECHANICAL CHARACTERISTICS

Case	TO-220AC
Marking	Alpha-numeric
Pin out	See below

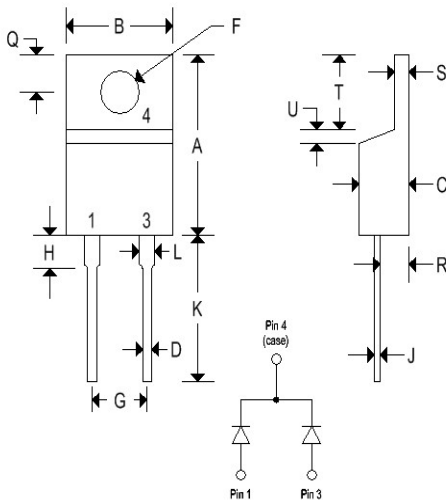

	TO-220AC			
	Inches		Millimeters	
	Min	Max	Min	Max
A	0.595	0.620	15.110	15.750
B	0.380	0.405	9.650	10.290
C	0.160	0.190	4.060	4.820
D	0.142	0.147	3.610	3.730
F	0.142	0.147	3.610	3.730
G	0.190	0.210	4.830	5.330
H	0.110	0.130	2.790	3.300
J	0.018	0.025	0.460	0.640
K	0.500	0.562	12.700	14.270
L	0.045	0.050	1.140	1.270
Q	0.100	0.120	2.540	3.040
R	0.080	0.110	2.040	2.790
S	0.045	0.055	1.140	1.390
T	0.235	0.255	5.970	6.480
U	0.030	0.050	0.760	1.270

DIGITRON SEMICONDUCTORS

MUR5150E

5A SCHOTTKY RECTIFIER

Available Non-RoHS (standard) or RoHS compliant (add PBF suffix).
 Available as "HR" (high reliability) screened per MIL-PRF-19500, JANTX level. Add "HR" suffix to base part number.

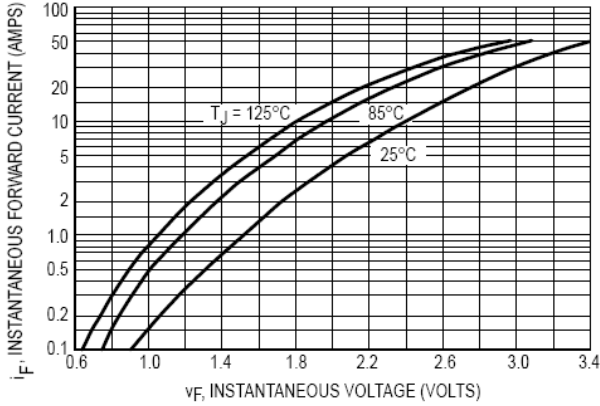

Figure 1. Typical Forward Voltage

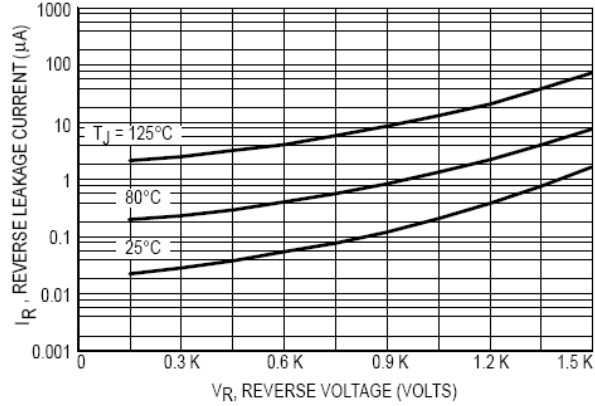

Figure 2. Typical Reverse Leakage Current

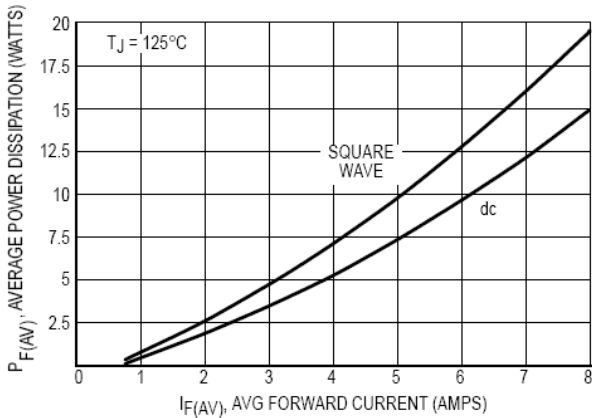

Figure 3. Forward Power Dissipation

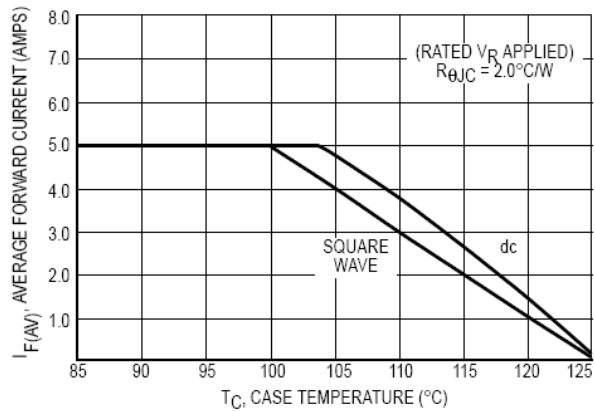

Figure 4. Current Derating Case

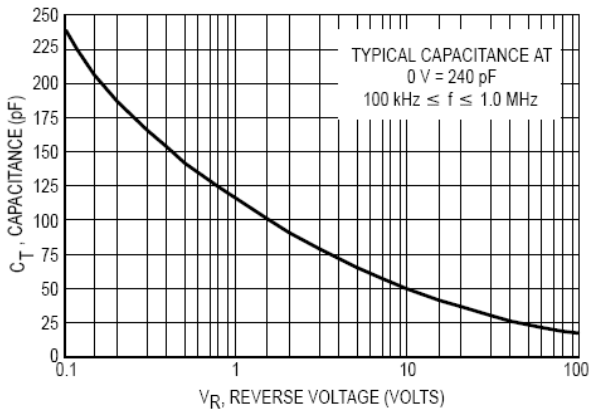

Figure 5. Typical Capacitance

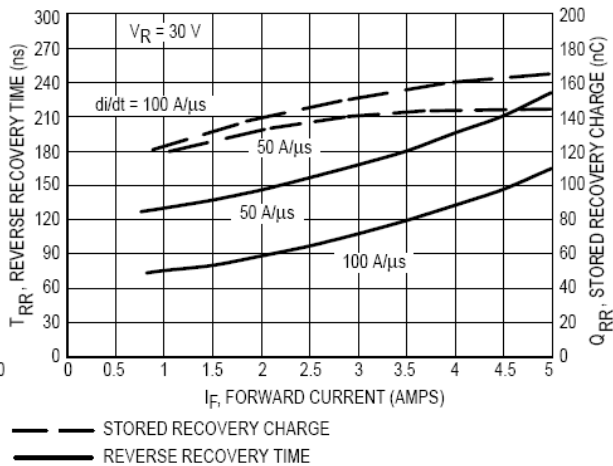

Figure 6. Typical Reverse Switching Characteristics