

DIGITRON SEMICONDUCTORS

MUR170E-MUR1100E

1A SCHOTTKY RECTIFIER

MAXIMUM RATINGS

Rating	Symbol	MUR				Unit
		170E	180E	190E	1100E	
Peak repetitive reverse voltage Working peak reverse voltage DC blocking voltage	V_{RRM} V_{RWM} V_R	700	800	900	1000	V
Average rectified forward current (square wave) Mounting method per note 2	$I_{F(AV)}$	1.0 @ $T_A = 95^\circ\text{C}$				A
Non-repetitive peak surge current (surge applied at rated load conditions halfwave, single phase, 60Hz)	I_{FSM}	35				A
Operating and storage junction temperature range	T_J, T_{stg}	-65 to +175				$^\circ\text{C}$
Maximum thermal resistance Junction to ambient	$R_{\theta JA}$	Note 1				$^\circ\text{C/W}$

ELECTRICAL CHARACTERISTICS ($T_C = 25^\circ\text{C}$ unless otherwise noted)

Parameter	Symbol	MUR				Unit
		170E	180E	190E	1100E	
Maximum instantaneous forward voltage ⁽¹⁾ ($I_F = 1.0\text{A}, T_J = 150^\circ\text{C}$) ($I_F = 1.0\text{A}, T_J = 25^\circ\text{C}$)	V_F	1.50 1.75				V
Maximum instantaneous reverse current ⁽¹⁾ (Rated dc voltage, $T_J = 100^\circ\text{C}$) (Rated dc voltage, $T_J = 25^\circ\text{C}$)	I_R	600 10				μA
Maximum reverse recovery time ($I_F = 1.0\text{A}, di/dt = 50\text{A}/\mu\text{s}$) ($I_F = 0.5\text{A}, I_R = 1.0\text{A}, I_{REC} = 0.25\text{A}$)	t_{rr}	100 75				ns
Maximum forward recovery time ($I_F = 1.0\text{A}, di/dt = 100\text{A}/\mu\text{s}, I_{REC}$ to 1.0V)	t_{fr}	75				ns
Controlled avalanche energy	W_{AVAL}	10				mJ

Note 1: Pulse test: Pulse width = 300 μs , duty cycle $\leq 2.0\%$.
Note 2: PC board with 1 1/2" x 1 1/2" copper surface.

MECHANICAL CHARACTERISTICS

Case	DO-41
Marking	Body painted, alpha-numeric
Polarity	Cathode band

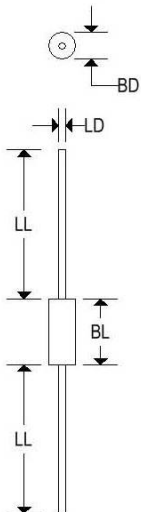

	DO-41			
	Inches		Millimeters	
	Min	Max	Min	Max
BD	-	0.107	-	2.720
BL	-	0.205	-	5.207
LD	0.028	0.034	0.711	0.864
LL	1.000	-	25.400	-

DIGITRON SEMICONDUCTORS

MUR170E-MUR1100E

10A SCHOTTKY RECTIFIER

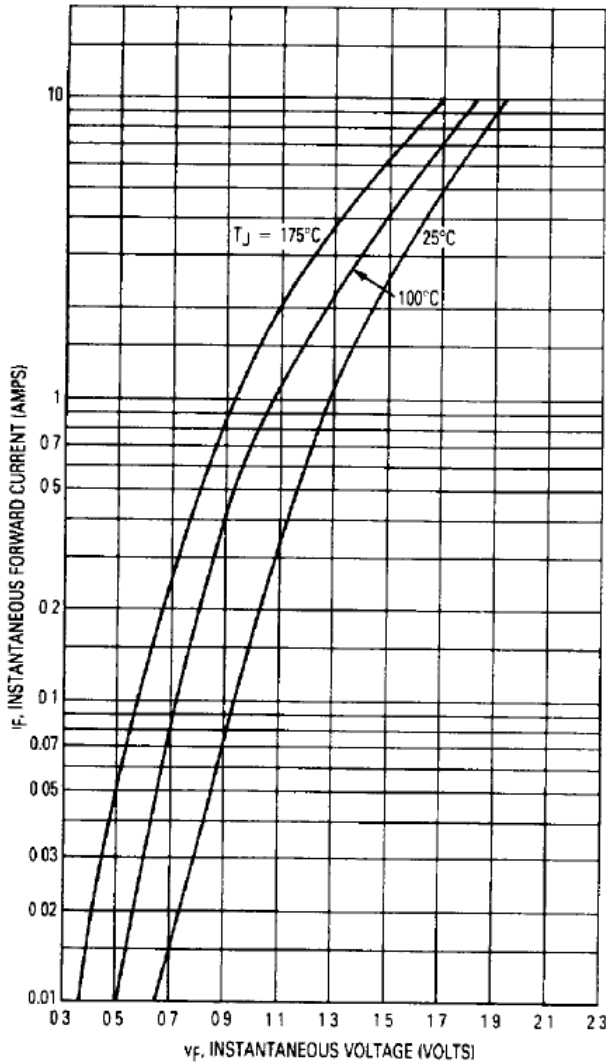

Figure 1. Typical Forward Voltage

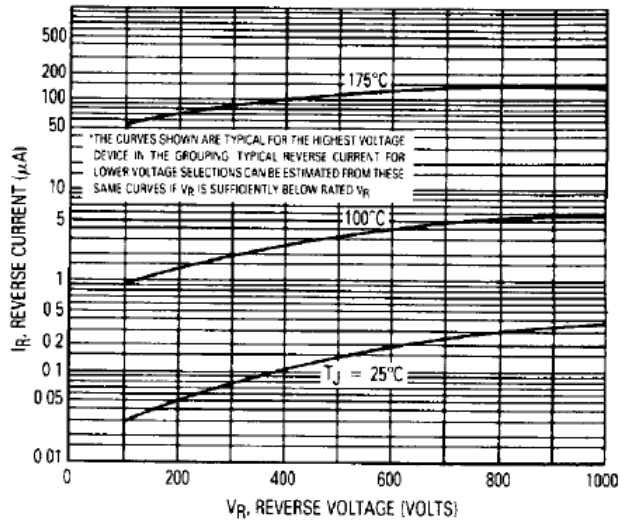

Figure 2. Typical Reverse Current*

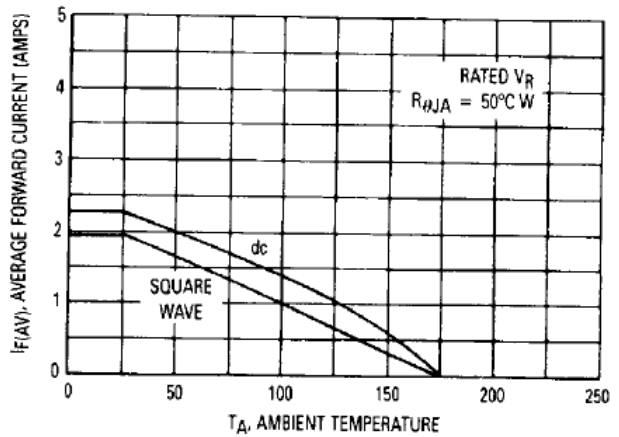

Figure 3. Current Derating (Mounting Method #3 Per Note 1)

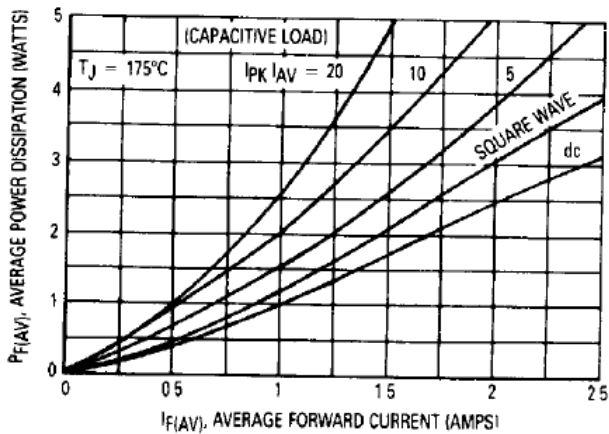

Figure 4. Power Dissipation

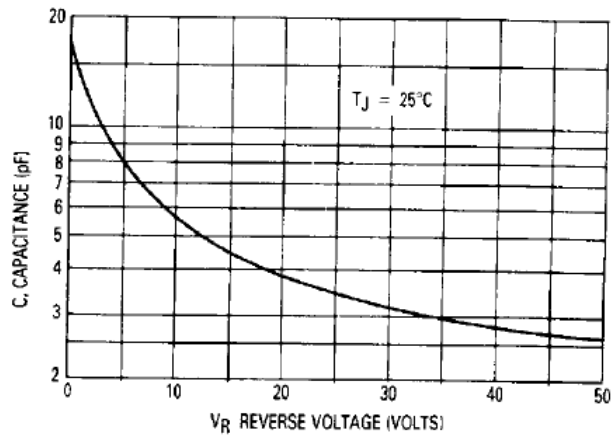

Figure 5. Typical Capacitance

DIGITRON SEMICONDUCTORS

MUR170E-MUR1100E

10A SCHOTTKY RECTIFIER

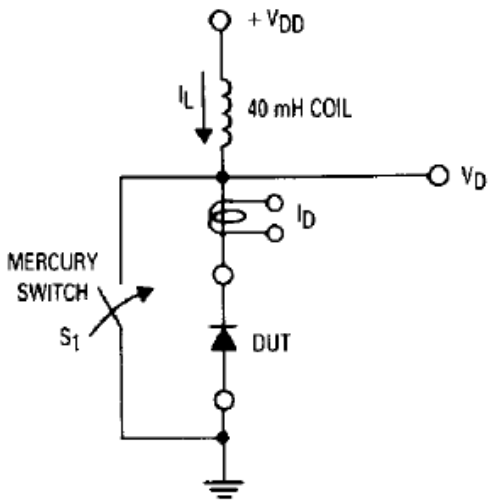

Figure 6. Test Circuit

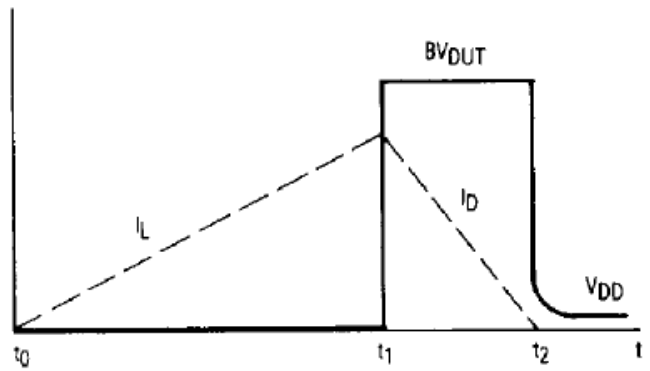

Figure 7. Current-Voltage Waveforms

Available Non-RoHS (standard) or RoHS compliant (add PBF suffix).
Available as "HR" (high reliability) screened per MIL-PRF-19500, JANTX level. Add "HR" suffix to base part number.