

DIGITRON SEMICONDUCTORS

MBR6035-MBR6045

60A SCHOTTKY RECTIFIER

MAXIMUM RATINGS

Rating	Symbol	MBR6035	MBR6045	Unit
Peak repetitive reverse voltage Working peak reverse voltage DC blocking voltage	V_{RRM} V_{RWM} V_R	35	45	V
Peak repetitive forward current (Rated V_R , square wave, 20kHz)	I_{FRM}	120 @ $T_C = 100^\circ\text{C}$		A
Average rectified forward current (Rated V_R)	I_o	60 @ $T_C = 100^\circ\text{C}$		A
Peak repetitive reverse surge current (2.0 μs , 1.0kHz)	I_{RRM}	2.0		A
Non-repetitive peak surge current (surge applied at rated load conditions, halfwave, single phase, 60Hz)	I_{FSM}	800		A
Operating junction temperature range	T_J	-65 to +150		$^\circ\text{C}$
Storage temperature range	T_{stg}	-65 to +175		$^\circ\text{C}$
Voltage rate of change (Rated V_R)	dv/dt	1000		V/ μs
Maximum thermal resistance Junction to case	$R_{\theta JC}$	1.0		$^\circ\text{C}/\text{W}$

ELECTRICAL CHARACTERISTICS ($T_C = 25^\circ\text{C}$ unless otherwise noted)

Parameter	Symbol	MBR6035	MBR6045	Unit
		Typical	Maximum	
Instantaneous forward voltage ⁽¹⁾ ($I_F = 60\text{A}$, $T_C = 25^\circ\text{C}$) ($I_F = 60\text{A}$, $T_C = 125^\circ\text{C}$) ($I_F = 120\text{A}$, $T_C = 125^\circ\text{C}$)	V_F	0.65 0.57 0.70	0.70 0.60 0.76	V
Instantaneous reverse current ⁽¹⁾ (Rated dc voltage, $T_C = 25^\circ\text{C}$) (Rated dc voltage, $T_C = 125^\circ\text{C}$)	I_R	0.1 55	0.3 100	mA
Capacitance ($V_R = 1.0\text{Vdc}$, $100\text{kHz} \leq f \leq 1.0\text{MHz}$)	C_t	3000	3700	pF

Note 1: Pulse test: Pulse width = 300 μs , duty cycle $\leq 2.0\%$.

DIGITRON SEMICONDUCTORS

MBR6035-MBR6045

60A SCHOTTKY RECTIFIER

MECHANICAL CHARACTERISTICS

Case	DO-5(R)
Marking	Alpha-numeric
Normal polarity	Cathode is stud
Reverse polarity	Anode is stud (add "R" suffix)

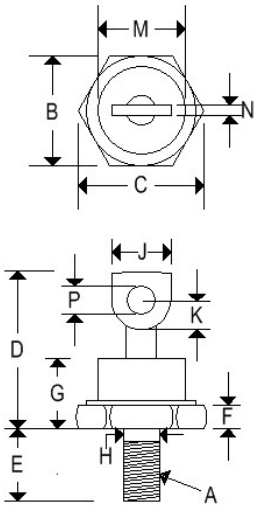

	DO-5(R)			
	Inches		Millimeters	
	Min	Max	Min	Max
A	¼-28 UNF2A threads			
B	0.669	0.688	16.990	17.480
C	-	0.794	-	20.160
D	-	1.000	-	25.400
E	0.422	0.453	10.720	11.510
F	0.115	0.200	2.920	5.080
G	-	0.450	-	11.430
H	0.220	0.249	5.580	6.320
J	0.250	0.375	6.350	9.530
K	0.156	-	3.960	-
M	-	0.667	-	16.940
N	0.030	0.080	0.760	2.030
P	0.140	0.175	3.560	4.450

Available Non-RoHS (standard) or RoHS compliant (add PBF suffix).

Available as "HR" (high reliability) screened per MIL-PRF-19500, JANTX level. Add "HR" suffix to base part number.

DIGITRON SEMICONDUCTORS

MBR6035-MBR6045

60A SCHOTTKY RECTIFIER

FIGURE 1 — TYPICAL FORWARD VOLTAGE

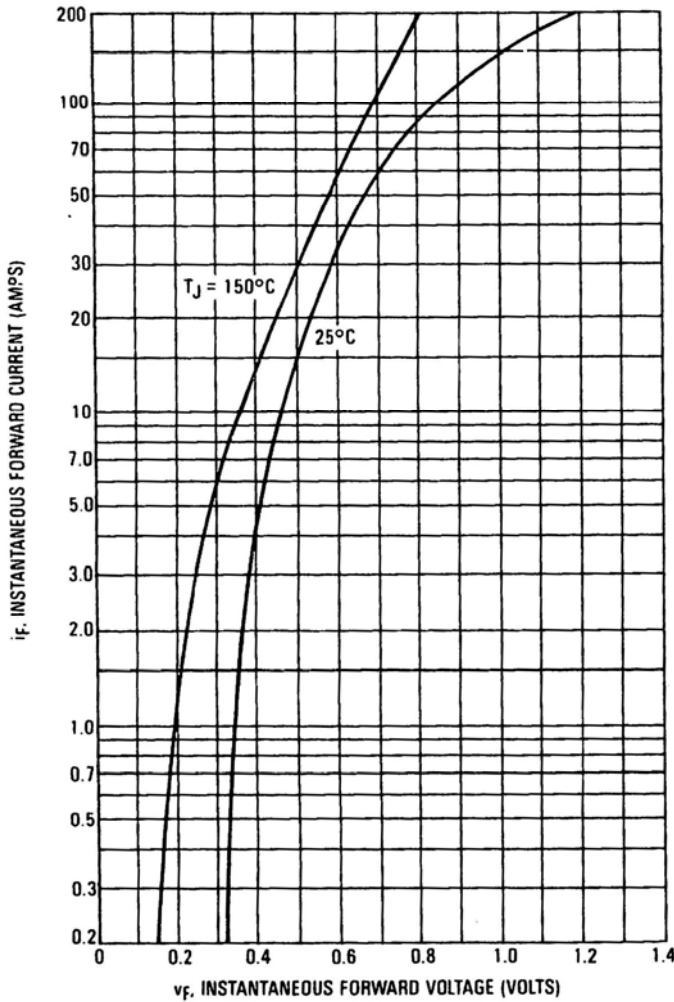

FIGURE 2 — TYPICAL REVERSE CURRENT

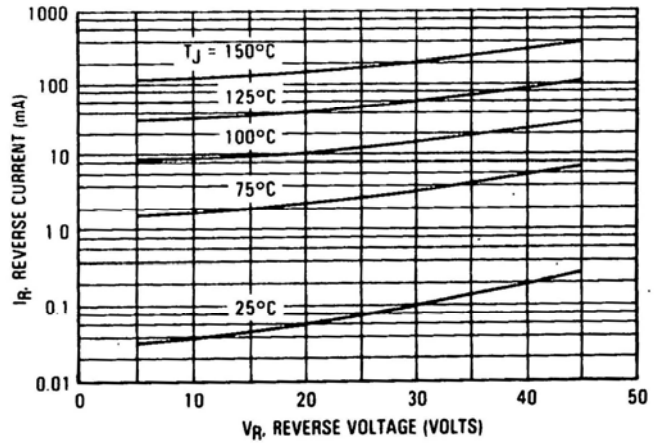
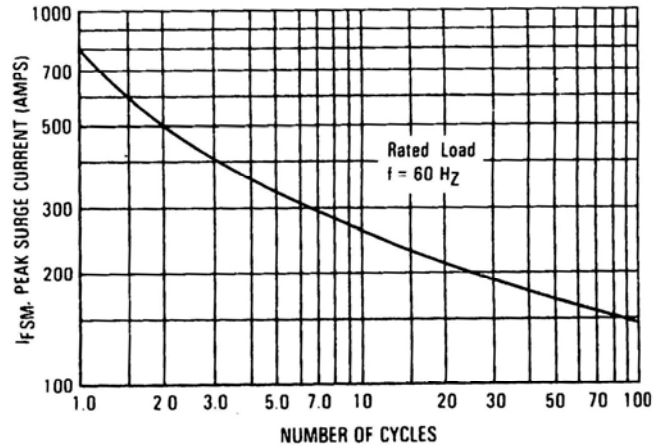

FIGURE 3 — MAXIMUM SURGE CAPABILITY



**NOTE 1
HIGH FREQUENCY OPERATION**

Since current flow in a Schottky rectifier is the result of majority carrier conduction, it is not subject to junction diode forward and reverse recovery transients due to minority carrier injection and stored charge. Satisfactory circuit analysis work may be performed by using a model consisting of an ideal diode in parallel with a variable capacitance. (See Figure 4.)

Rectification efficiency measurements show that operation will be satisfactory up to several megahertz. For example, relative waveform rectification efficiency is approximately 70 per cent at 2.0 MHz, e.g., the ratio of dc power to RMS power in the load is 0.28 at this frequency, whereas perfect rectification would yield 0.406 for sine wave inputs. However, in contrast to ordinary junction diodes, the loss in waveform efficiency is not indicative of power loss; it is simply a result of reverse current flow through the diode capacitance, which lowers the dc output voltage.

FIGURE 4 — CAPACITANCE

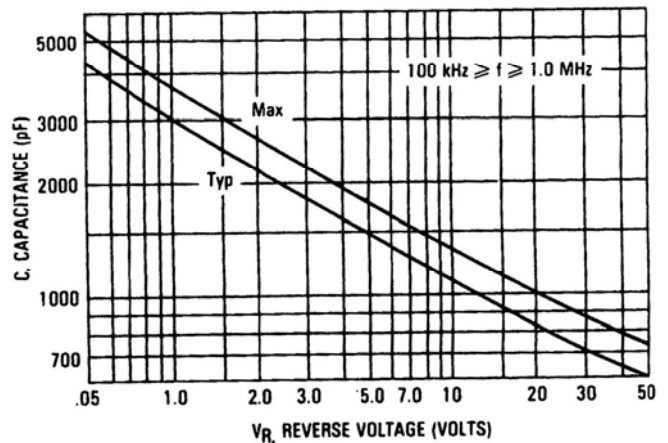

DIGITRON SEMICONDUCTORS

MBR6035-MBR6045 60A SCHOTTKY RECTIFIER

FIGURE 5 — FORWARD CURRENT DERATING

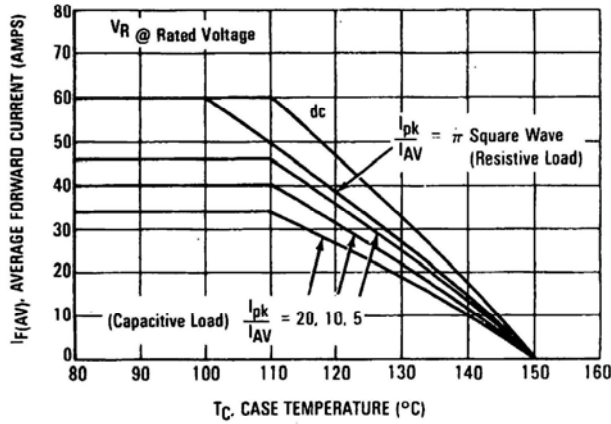

FIGURE 6 — POWER DISSIPATION

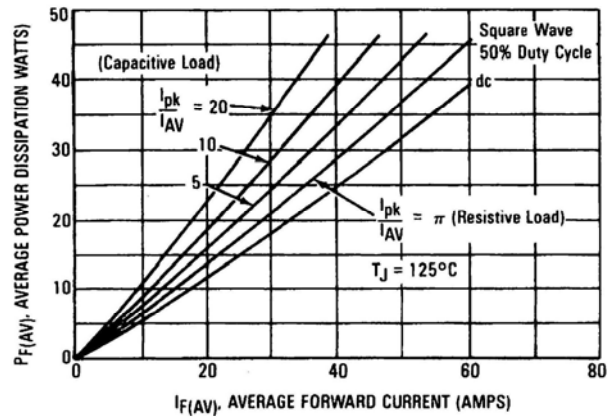
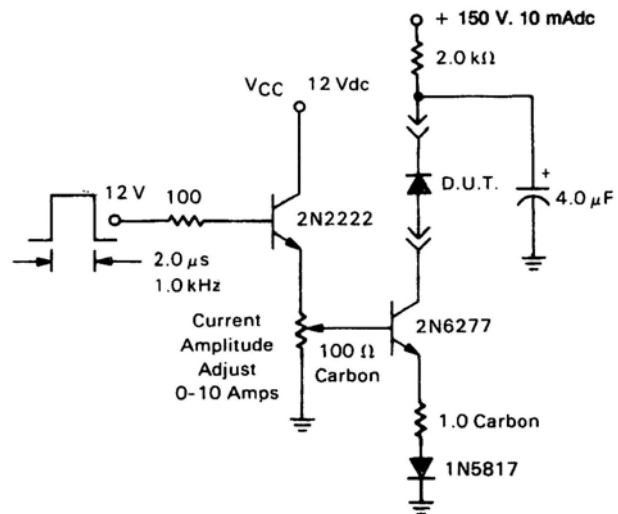
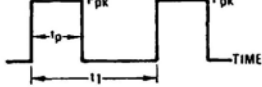

FIGURE 7 — TEST CIRCUIT FOR dv/dt AND REVERSE SURGE CURRENT



NOTE 2



DUTY CYCLE, $D = t_p/t_1$
 PEAK POWER, P_{pk} , is peak of an equivalent square power pulse

To determine maximum junction temperature of the diode in a given situation, the following procedure is recommended:
 The temperature of the case should be measured using a thermocouple placed on the case. The thermal mass connected to the case is normally large enough so that it will not significantly respond to heat surges generated in the diode as a result of pulsed operation once steady-state conditions are achieved. Using the measured value of T_C , the junction temperature may be determined by:

$$T_J = T_C + \Delta T_{JC}$$

where ΔT_C is the increase in junction temperature above the case temperature. It may be determined by:

$$\Delta T_{JC} = P_{pk} \cdot R_{\theta JC} [D + (1 - D) \cdot r(t_1 + t_p) + r(t_p) - r(t_1)]$$

where $r(t)$ = normalized value of transient thermal resistance at time, t , from Figure 8, i.e.:

$r(t_1 + t_p)$ = normalized value of transient thermal resistance at time $t_1 + t_p$

FIGURE 8 — THERMAL RESPONSE

