



ST1433A 

P Channel Enhancement Mode MOSFET

-3.0A

DESCRIPTION

ST1433A is the P-Channel logic enhancement mode power field effect transistor which is produced using high cell density, DMOS trench technology. This high density process is especially tailored to minimize on-state resistance. These devices are particularly suited for low voltage application such as cellular phone and notebook computer power management, other battery powered circuits, and low in-line power loss are required. The product is in a very small outline surface mount package.

PIN CONFIGURATION SOT-353 (SC-70-5L)

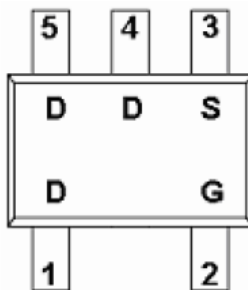

FEATURE

- -30V/-3.0A, $R_{DS(ON)} = 120m\Omega$
@ $V_{GS} = -10.0V$
- -30V/-2.5A, $R_{DS(ON)} = 135m\Omega$
@ $V_{GS} = -4.5V$
- -30V/-1.5A, $R_{DS(ON)} = 165m\Omega$
@ $V_{GS} = -2.5V$
- Super high density cell design for extremely low $R_{DS(ON)}$
- Exceptional on-resistance and maximum DC current capability
- SOT-353 package design

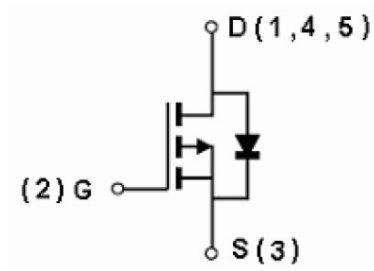



ST1433A 

P Channel Enhancement Mode MOSFET

-3.0A

ABSOLUTE MAXIMUM RATINGS (Ta = 25°C Unless otherwise noted)

Parameter		Symbol	Typical	Unit
Drain-Source Voltage		V _{DSS}	-30	V
Gate-Source Voltage		V _{GSS}	±12	V
Continuous Drain Current (T _J =150°C)	T _A =25°C T _A =70°C	I _D	-3.0 -2.0	A
Pulsed Drain Current		I _{DM}	-7	A
Continuous Source Current (Diode Conduction)		I _S	-1.6	A
Power Dissipation	T _A =25°C T _A =70°C	P _D	1.25 0.8	W
Operation Junction Temperature		T _J	150	°C
Storage Temperature Range		T _{STG}	-55/150	°C
Thermal Resistance-Junction to Ambient		R _{θJA}	105	°C/W



ST1433A 

P Channel Enhancement Mode MOSFET

-3.0A

ELECTRICAL CHARACTERISTICS (Ta = 25°C Unless otherwise noted)

Parameter	Symbol	Condition	Min	Typ	Max	Unit
Static						
Drain-Source Breakdown Voltage	$V_{(BR)DSS}$	$V_{GS}=0V, I_D=-250\mu A$	-30			V
Gate Threshold Voltage	$V_{GS(th)}$	$V_{DS}=V_{GS}, I_D=-250\mu A$	-0.4		-1.0	V
Gate Leakage Current	I_{GSS}	$V_{DS}=0V, V_{GS}=\pm 12V$			± 100	nA
Zero Gate Voltage Drain Current	I_{DSS}	$V_{DS}=-20V, V_{GS}=0V$			-1	uA
		$V_{DS}=-20V, V_{GS}=0V$ $T_J=55^\circ C$			-5	
On-State Drain Current	$I_{D(on)}$	$V_{DS}\leq -5V, V_{GS}=-4.5V$	-5			A
		$V_{DS}\leq -5V, V_{GS}=-2.5V$	-3			
Drain-source On-Resistance	$R_{DS(on)}$	$V_{GS}=-10.0V, I_D=-3.0A$		0.100	0.120	Ω
		$V_{GS}=-4.5V, I_D=-2.5A$		0.115	0.135	
		$V_{GS}=-2.5V, I_D=-1.5A$		0.135	0.165	
Forward Transconductance	g_{fs}	$V_{DS}=-10V, I_D=-2.8V$		4		S
Diode Forward Voltage	V_{SD}	$I_S=-1.2A, V_{GS}=0V$		-0.8	-1.2	V
Dynamic						
Total Gate Charge	Q_g	$V_{DS}=-15V$ $V_{GS}=-4.5V$ $I_D=-2.0A$		5.8		nC
Gate-Source Charge	Q_{gs}			1.0		
Gate-Drain Charge	Q_{gd}			1.5		
Input Capacitance	C_{iss}	$V_{DS}=-15V$ $V_{GS}=0V$ $F=1MHz$		385		pF
Output Capacitance	C_{oss}			55		
Reverse Transfer Capacitance	C_{rss}			40		
Turn-On Time	$t_{d(on)tr}$	$V_{DD}=-15V$ $R_L=15\Omega$ $I_D=-1A$ $V_{GEN}=-10V$ $R_G=3\Omega$		6		nS
				3.9		
Turn-Off Time	$t_{d(off)tf}$			40		
				15		

TYPICAL CHARACTERISTICS

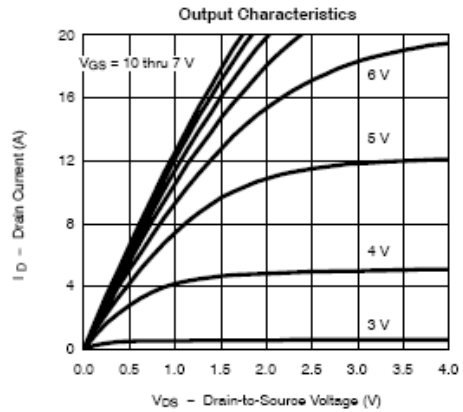
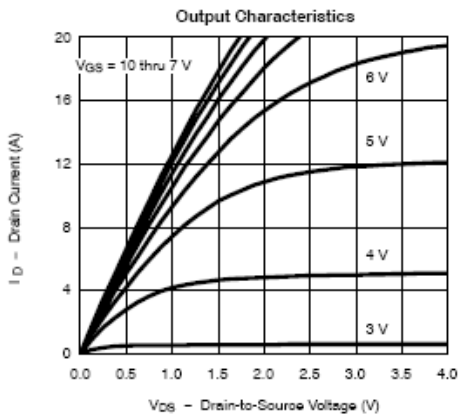
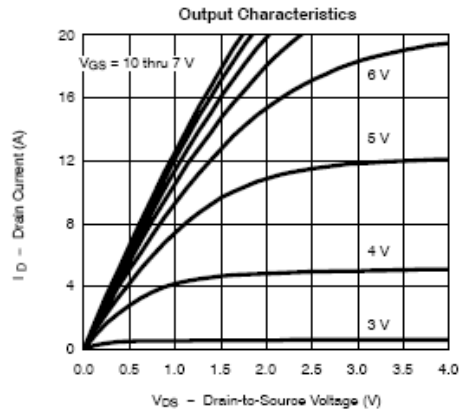
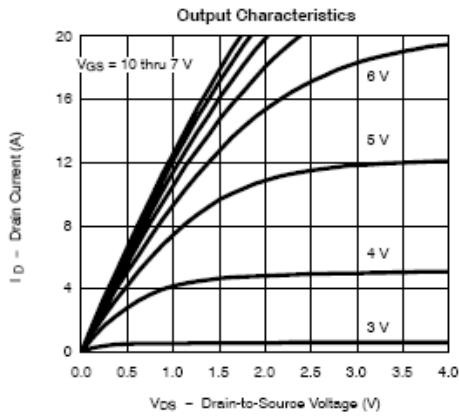

TYPICAL CHARACTERISTICS

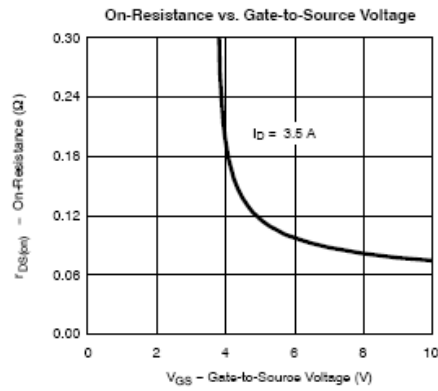
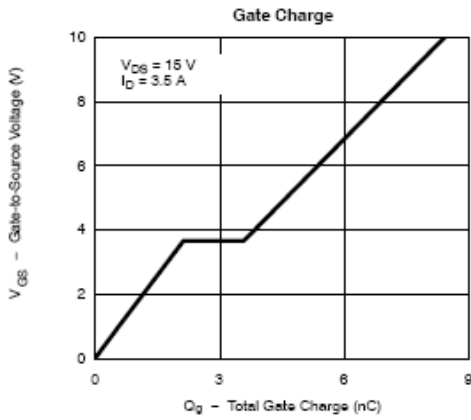
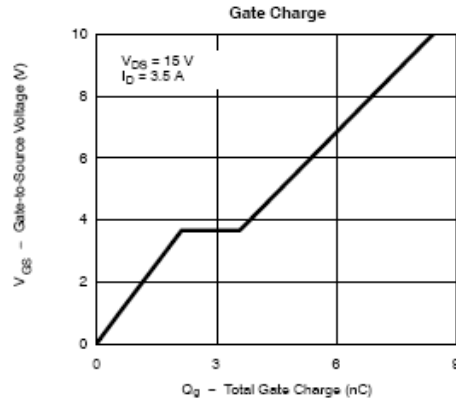
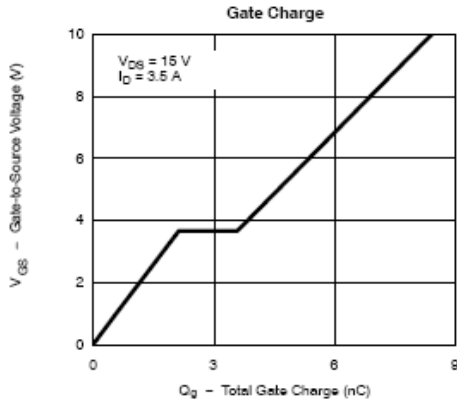

TYPICAL CHARACTERISTICS

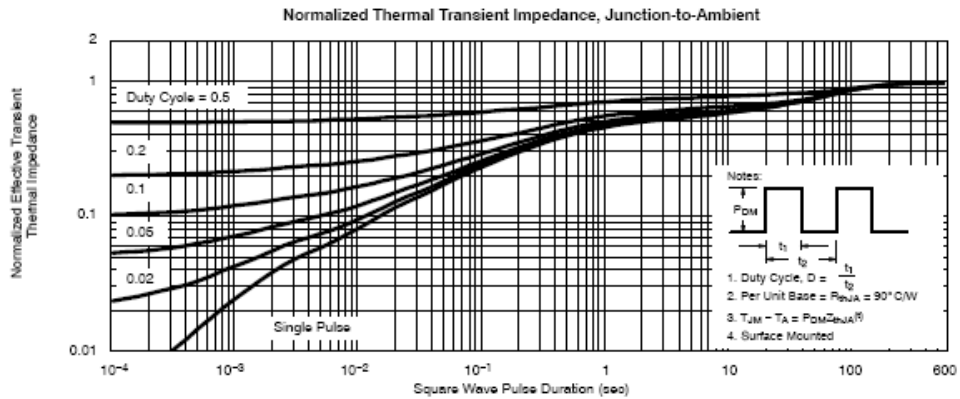
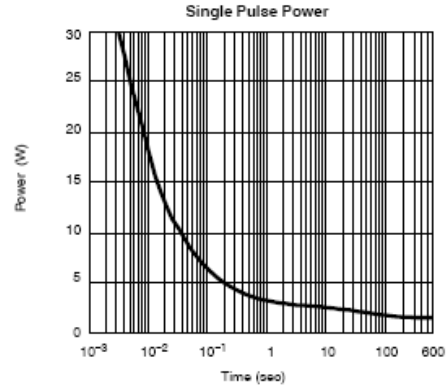
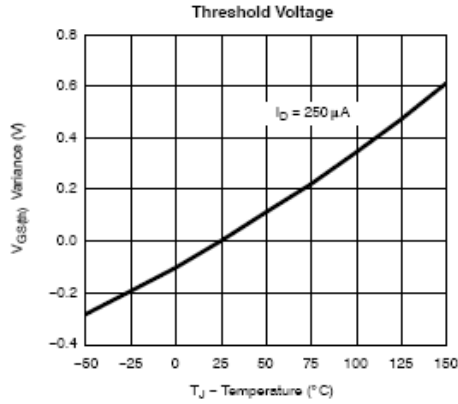

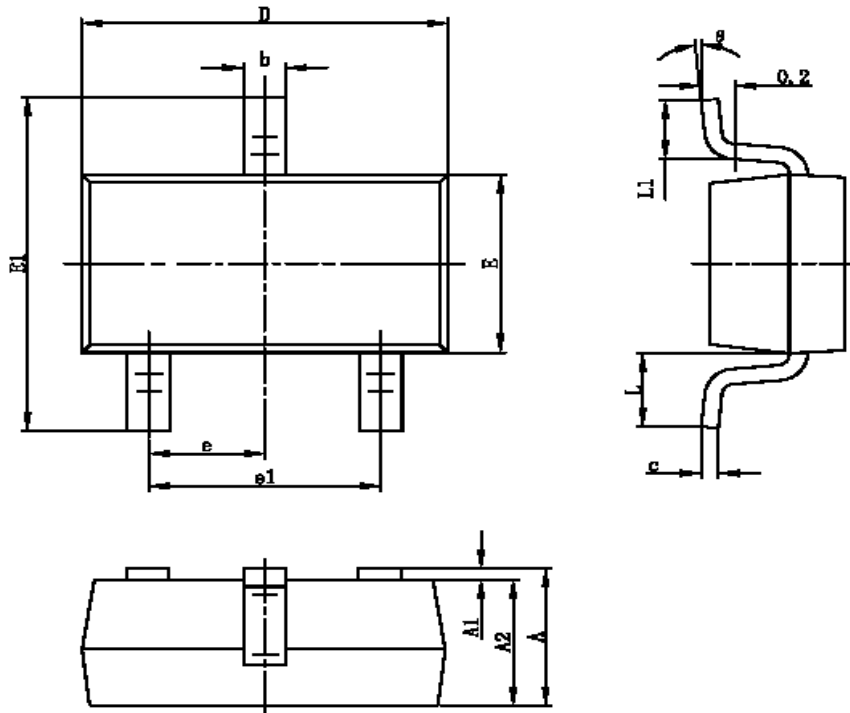
SOT-23-3L PACKAGE OUTLINE

Symbol	Dimensions In Millimeters		Dimensions In Inches	
	Min	Max	Min	Max
A	1.050	1.250	0.041	0.049
A1	0.000	0.100	0.000	0.004
A2	1.050	1.150	0.041	0.045
b	0.300	0.400	0.012	0.016
c	0.100	0.200	0.004	0.008
D	2.820	3.020	0.111	0.119
E	1.500	1.700	0.059	0.067
E1	2.650	2.950	0.104	0.116
e	0.950TYP		0.037TYP	
e1	1.800	2.000	0.071	0.079
L	0.700REF		0.028REF	
L1	0.300	0.600	0.012	0.024
θ	0°	8°	0°	8°