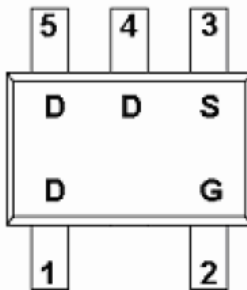
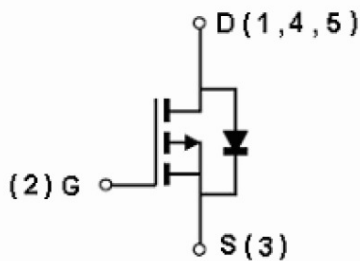

DESCRIPTION

ST1413A is the P-Channel logic enhancement mode power field effect transistor which is produced using high cell density, DMOS trench technology. This high density process is especially tailored to minimize on-state resistance. These devices are particularly suited for low voltage application such as cellular phone and notebook computer power management, other battery powered circuits, and low in-line power loss are required. The product is in a very small outline surface mount package.

**PIN CONFIGURATION
SOT-353 (SC-70-5L)**

FEATURE

- -20V/-3.4A, $R_{DS(ON)} = 130m\Omega$
@ $V_{GS} = -4.5V$
- -20V/-2.0A, $R_{DS(ON)} = 150m\Omega$
@ $V_{GS} = -2.5V$
- Super high density cell design for extremely low $R_{DS(ON)}$
- Exceptional on-resistance and maximum DC current capability
- SOT-353 package design





ST1413A 

P Channel Enhancement Mode MOSFET

-3.4A

ABSOLUTE MAXIMUM RATINGS (Ta = 25°C Unless otherwise noted)

Parameter		Symbol	Typical	Unit
Drain-Source Voltage		V _{DSS}	-20	V
Gate-Source Voltage		V _{GSS}	±12	V
Continuous Drain Current (T _J =150°C)	T _A =25°C	I _D	-3.4	A
	T _A =70°C		-2.0	
Pulsed Drain Current		I _{DM}	-7	A
Continuous Source Current (Diode Conduction)		I _S	-1.6	A
Power Dissipation	T _A =25°C	P _D	1.25	W
	T _A =70°C		0.8	
Operation Junction Temperature		T _J	150	°C
Storage Temperature Range		T _{STG}	-55/150	°C
Thermal Resistance-Junction to Ambient		R _{θJA}	105	°C/W



ST1413A 

P Channel Enhancement Mode MOSFET

-3.4A

ELECTRICAL CHARACTERISTICS (Ta = 25°C Unless otherwise noted)

Parameter	Symbol	Condition	Min	Typ	Max	Unit
Static						
Drain-Source Breakdown Voltage	$V_{(BR)DSS}$	$V_{GS}=0V, I_D=-250\mu A$	-20			V
Gate Threshold Voltage	$V_{GS(th)}$	$V_{DS}=V_{GS}, I_D=-250\mu A$	-0.4		-1.0	V
Gate Leakage Current	I_{GSS}	$V_{DS}=0V, V_{GS}=\pm 12V$			± 100	nA
Zero Gate Voltage Drain Current	I_{DSS}	$V_{DS}=-20V, V_{GS}=0V$			-1	uA
		$V_{DS}=-20V, V_{GS}=0V$ $T_J=55^\circ C$			-5	
On-State Drain Current	$I_{D(on)}$	$V_{DS}\leq -5V, V_{GS}=-4.5V$	-6			A
		$V_{DS}\leq -5V, V_{GS}=-2.5V$	-3			
Drain-source On-Resistance	$R_{DS(on)}$	$V_{GS}=-4.5V, I_D=-3.4A$		0.100	0.130	Ω
		$V_{GS}=-2.5V, I_D=-2.4A$		0.130	0.150	
Forward Transconductance	g_{fs}	$V_{DS}=-1.8V, I_D=-2.8V$		6.5		S
Diode Forward Voltage	V_{SD}	$I_S=-1.6A, V_{GS}=0V$		-0.8	-1.2	V
Dynamic						
Total Gate Charge	Q_g	$V_{DS}=-6V$ $V_{GS}=-4.5V$ $I_D=-2.8A$		4.8	8	nC
Gate-Source Charge	Q_{gs}			1.0		
Gate-Drain Charge	Q_{gd}			1.0		
Input Capacitance	C_{iss}	$V_{DS}=-6V$ $V_{GS}=0V$ $F=1MHz$		485		pF
Output Capacitance	C_{oss}			85		
Reverse Transfer Capacitance	C_{rss}			87		
Turn-On Time	$t_{d(on)}$ t_r	$V_{DD}=-6V$ $R_L=6\Omega$ $I_D=-1A$		11	17	nS
				13	20	
Turn-Off Time	$t_{d(off)}$ t_f	$V_{GEN}=-4.5V$ $R_G=6\Omega$		18	25	
				15	20	

TYPICAL CHARACTERISTICS

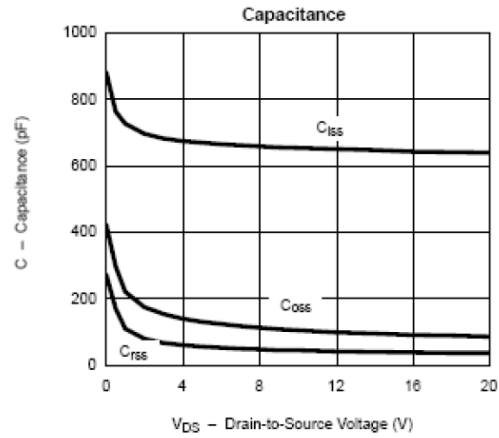
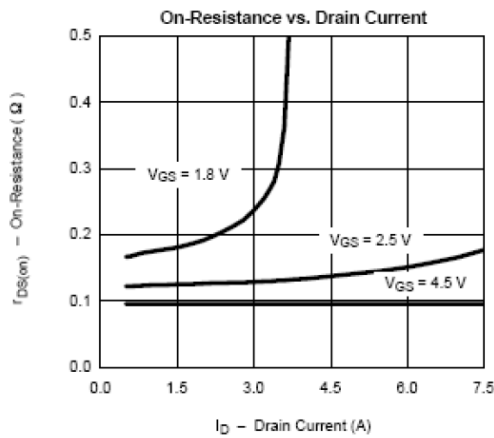
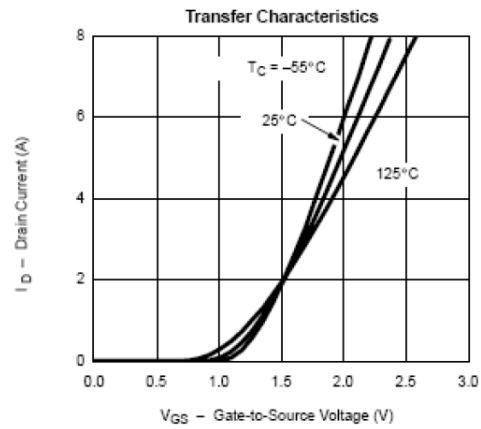
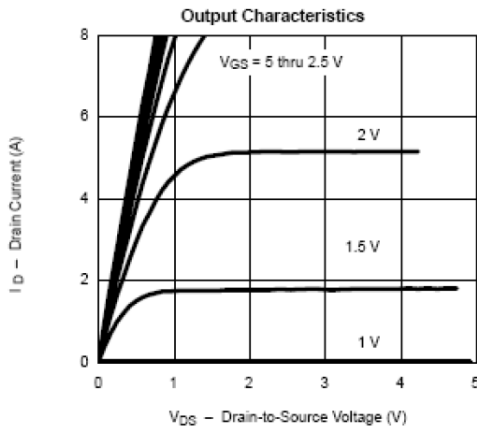

TYPICAL CHARACTERISTICS

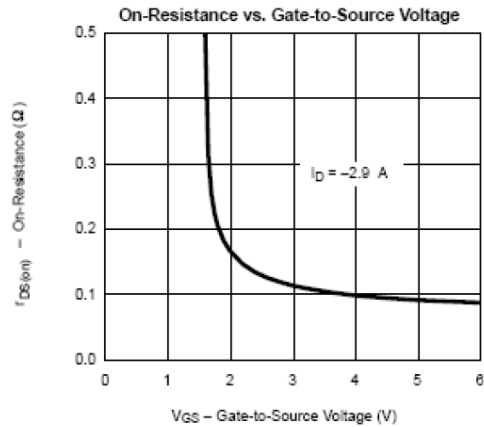
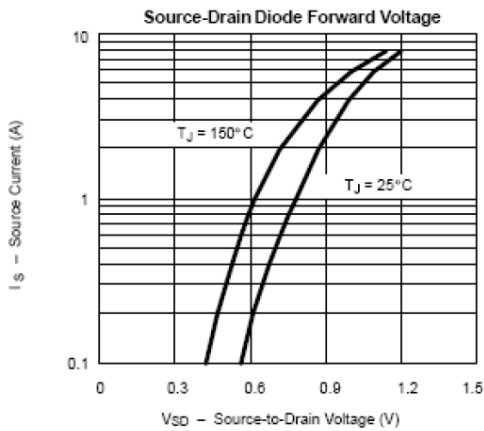
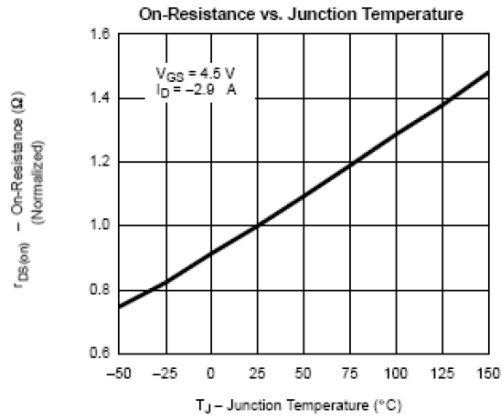
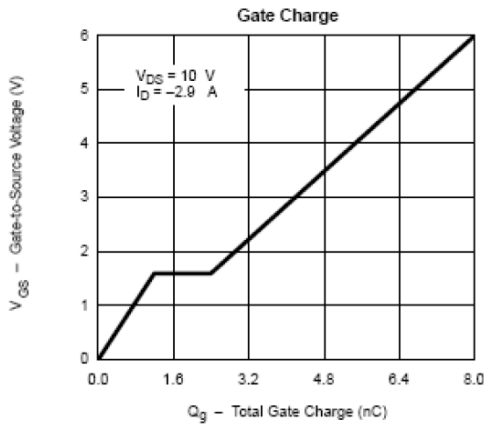

TYPICAL CHARACTERISTICS

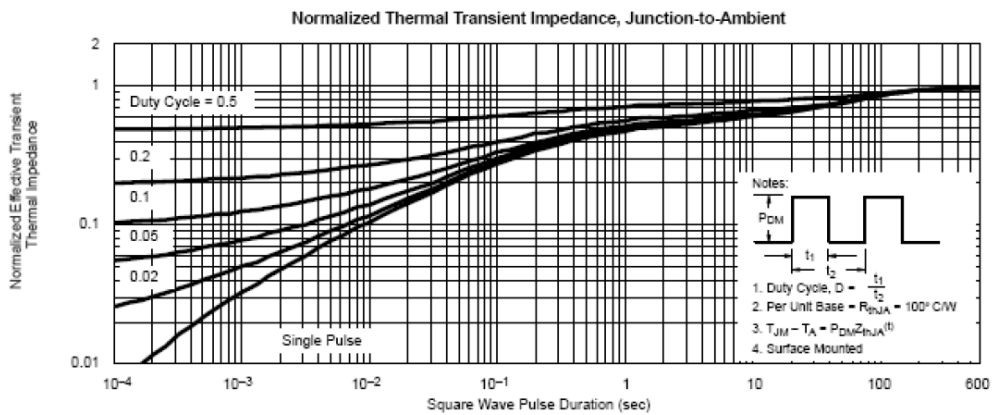
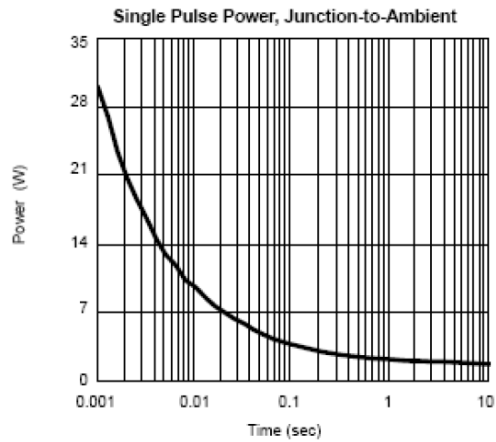
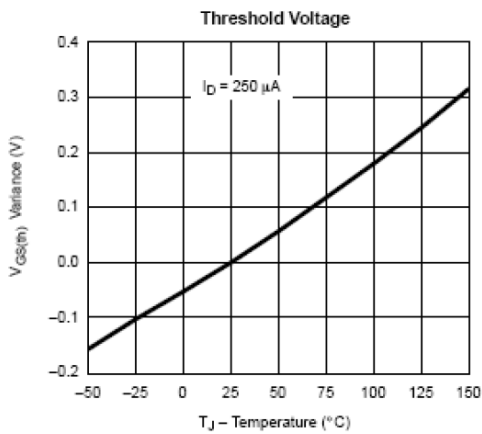

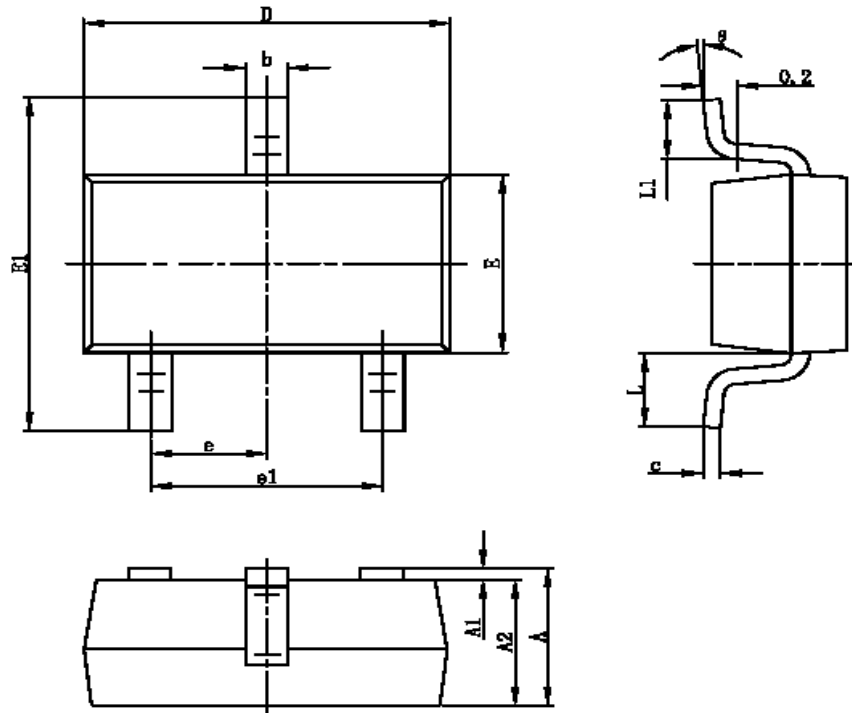
SOT-23-3L PACKAGE OUTLINE

Symbol	Dimensions In Millimeters		Dimensions In Inches	
	Min	Max	Min	Max
A	1.050	1.250	0.041	0.049
A1	0.000	0.100	0.000	0.004
A2	1.050	1.150	0.041	0.045
b	0.300	0.400	0.012	0.016
c	0.100	0.200	0.004	0.008
D	2.820	3.020	0.111	0.119
E	1.500	1.700	0.059	0.067
E1	2.650	2.950	0.104	0.116
e	0.950TYP		0.037TYP	
e1	1.800	2.000	0.071	0.079
L	0.700REF		0.028REF	
L1	0.300	0.600	0.012	0.024
θ	0°	8°	0°	8°