

**DESCRIPTION**

ST75N75 is used trench technology to provide excellent  $R_{DS(on)}$  and gate charge. Those devices are suitable for use as load switch or in PWM applications.

**PIN CONFIGURATION  
TO220-3L****MARKING****FEATURE**

- 75V/40.0A,  $R_{DS(on)} = 8m\Omega$  (Typ.) @ $V_{GS} = 10V$
- Super high density cell design for extremely low  $R_{DS(on)}$
- Exceptional on-resistance and maximum DC current capability
- TO-220 package design

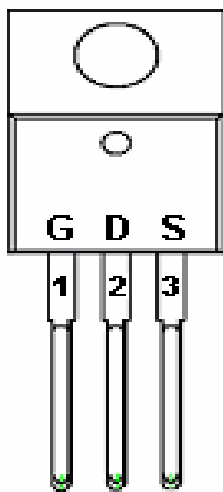
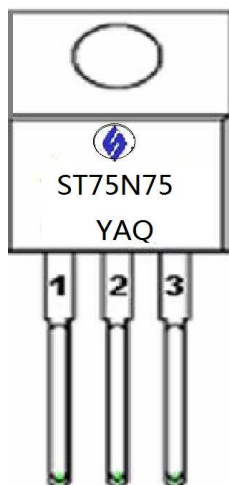
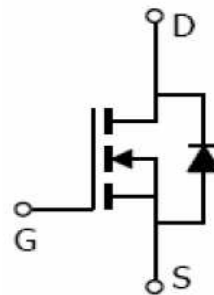

**ST75N75**

N Channel Enhancement Mode MOSFET

75.0A

**ABSOLUTE MAXIMUM RATINGS** (Ta = 25°C Unless otherwise noted )

Parameter	Symbol	Typical	Unit
Drain-Source Voltage	VDSS	75	V
Gate-Source Voltage	VGSS	±20	V
Continuous Drain Current (TJ=150°C)	ID	93.0 75.0	A
Pulsed Drain Current	IDM	370	A
Avalanche Current	IAS	70	A
Power Dissipation	PD	200	W
Operation Junction Temperature	TJ	175	°C
Storage Temperature Range	TSTG	-55/175	°C
Thermal Resistance-Junction to Ambient	RθJA	0.75	°C/W



**ST75N75**



N Channel Enhancement Mode MOSFET

75.0A

**ELECTRICAL CHARACTERISTICS** ( Ta = 25°C Unless otherwise noted )

Parameter	Symbol	Condition	Min	Typ	Max	Unit
<b>Static</b>						
Drain-Source Breakdown Voltage	$V_{(BR)DSS}$	$V_{GS}=0V, I_D=250\mu A$	75			V
Gate Threshold Voltage	$V_{GS(th)}$	$V_{DS}=V_{GS}, I_D=250\mu A$	2.0		4.0	V
Gate Leakage Current	$I_{GSS}$	$V_{DS}=0V, V_{GS}=\pm 20V$			$\pm 100$	nA
Zero Gate Voltage Drain Current	$I_{DSS}$	$V_{DS}=48V, V_{GS}=0V$			1	$\mu A$
Drain-source On-Resistance	$R_{DS(on)}$	$V_{GS}=10V, I_D=40A$		8	11	$m\Omega$
Diode Forward Voltage	$V_{SD}$	$I_S=1.0A, V_{GS}=0V$			1.2	V
<b>Dynamic</b>						
Total Gate Charge	$Q_g$	$V_{DS}=4.5V, V_{DS}=70V$ $I_D=75A$		30		nC
Gate-Source Charge	$Q_{gs}$			29		
Gate-Drain Charge	$Q_{gd}$			31		
Input Capacitance	$C_{iss}$	$V_{DS} = 20V, V_{GS}=0V$ $F=1MHz$		4780		pF
Output Capacitance	$C_{oss}$			540		
Reverse Transfer Capacitance	$C_{rss}$			180		
Turn-On Time	$t_{d(on)}$ $t_r$	$V_{DD}=30V, R_L= 15\Omega$ $V_{DS}=10V, R_G=1\Omega$		48		nS
Turn-Off Time	$t_{d(off)}$ $t_f$			36		
				150		
				49		

**TYPICAL CHARACTERISTICS**

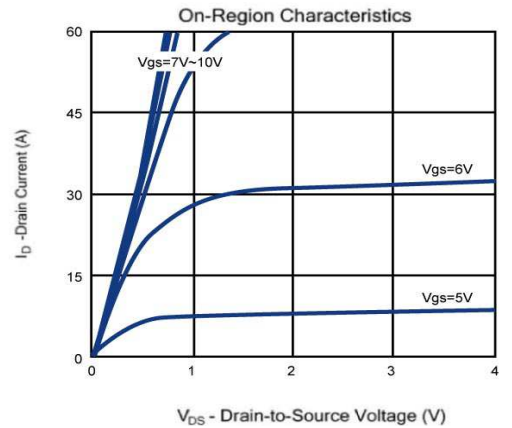
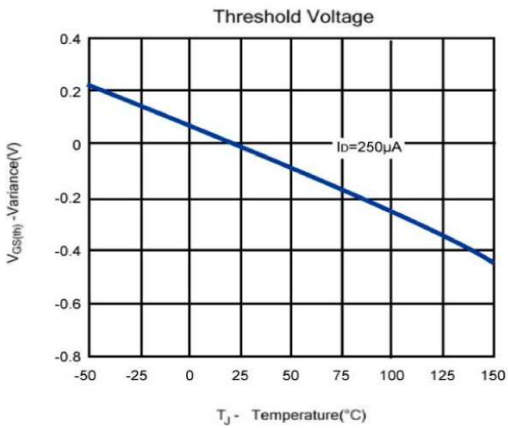
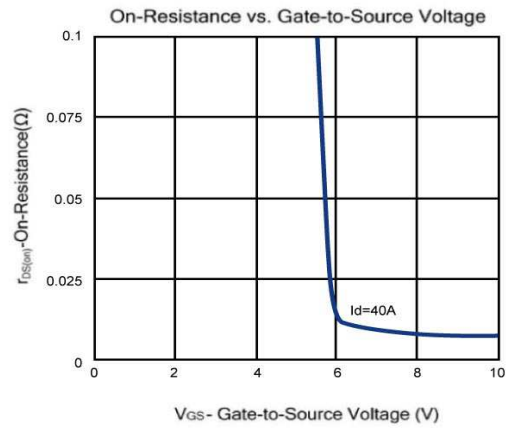
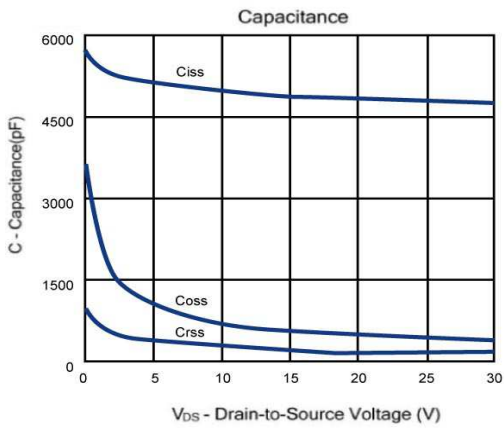
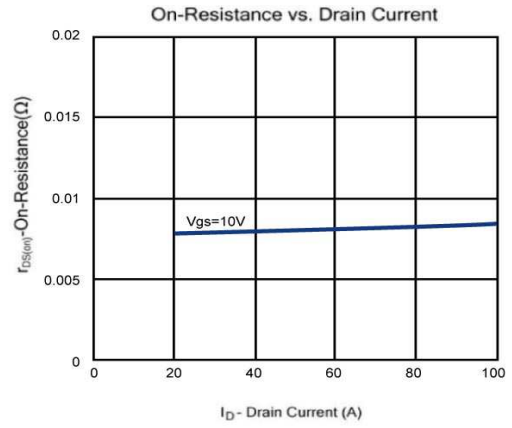
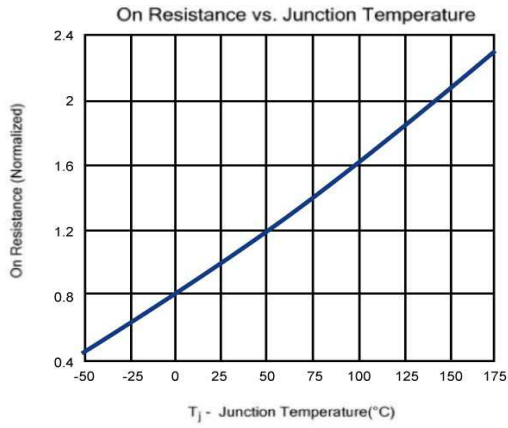

**TYPICAL CHARACTERISTICS**

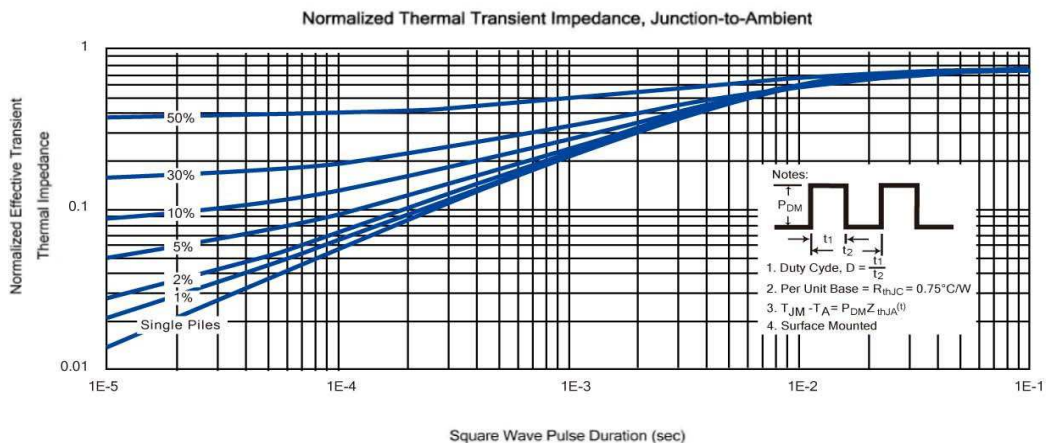
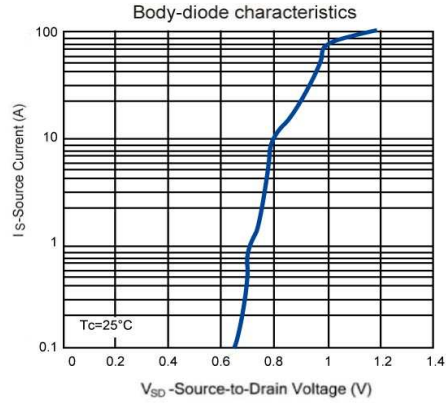
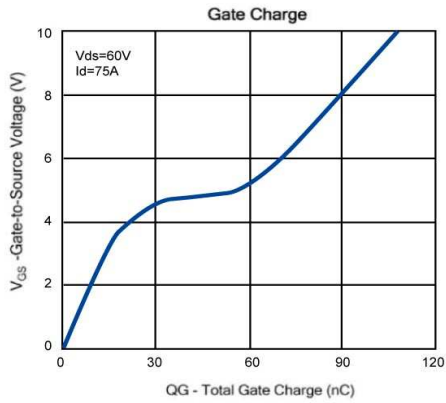

**TO220-3L PACKAGE OUTLINE**

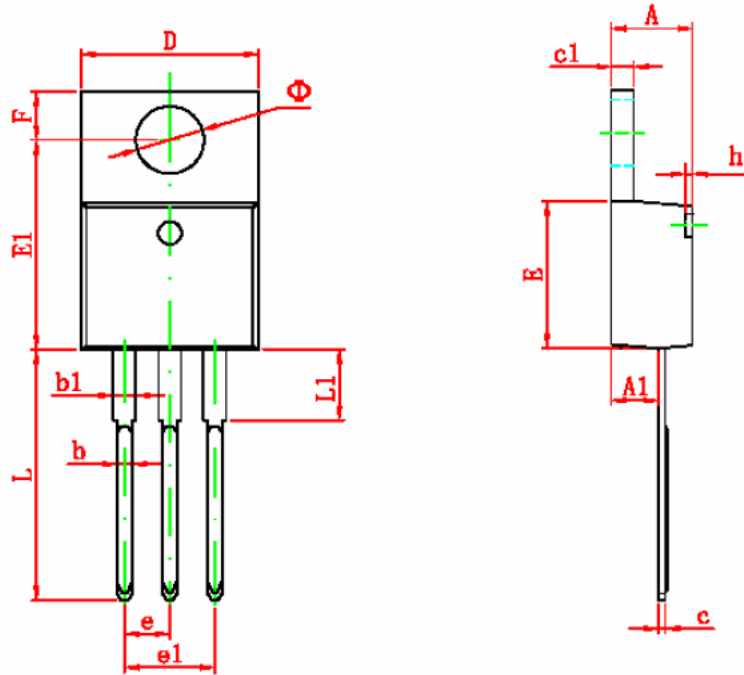

Symbol	Dimensions In Millimeters		Dimensions In Inches	
	Min	Max	Min	Max
A	4.470	4.670	0.176	0.184
A1	2.520	2.820	0.099	0.111
b	0.710	0.910	0.028	0.036
b1	1.170	1.370	0.046	0.054
c	0.310	0.530	0.012	0.021
c1	1.170	1.370	0.046	0.054
D	10.010	10.310	0.394	0.406
E	8.500	8.900	0.335	0.350
E1	12.060	12.460	0.475	0.491
e	2.540 TYP		0.100 TYP	
e1	4.980	5.180	0.196	0.204
F	2.590	2.890	0.102	0.114
h	0.000	0.300	0.000	0.012
L	13.400	13.800	0.528	0.543
L1	3.560	3.960	0.140	0.156
• •	3.735	3.935	0.147	0.155