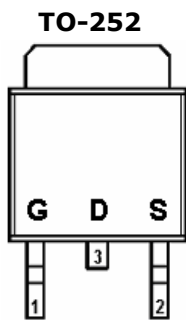
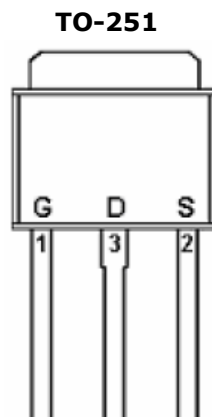


**DESCRIPTION**

STP601/STP601D is the P-Channel logic enhancement mode power field effect transistor which is produced using high cell density, DMOS trench technology. The STP601 has been designed specially to improve the overall efficiency of DC/DC converters using either synchronous or conventional switching PWM controllers. It has been optimized for low gate charge, low  $R_{DS(ON)}$  and fast switching speed.

**PIN CONFIGURATION (D-PAK)**


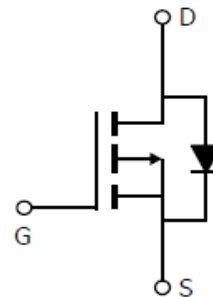
(STP601D)



(STP610)

**FEATURE**

- -60V/-20.0A,  $R_{DS(ON)} = 20m\Omega$ (typ.) @ $V_{GS} = -10V$
- -60V/-20.0A,  $R_{DS(ON)} = 27m\Omega$  @ $V_{GS} = -4.5V$
- Super high density cell design for extremely low  $R_{DS(ON)}$
- Exceptional on-resistance and maximum DC current capability
- TO-252,TO-251 package design

**PART MARKING**


**Y: Year Code**  
**A: Week Code**  
**Q: Process Code**



**STP601 / STP601D**



P Channel Enhancement Mode MOSFET

-30A

**ABSOLUTE MAXIMUM RATINGS** (Ta = 25°C Unless otherwise noted)

Parameter	Symbol	Typical	Unit
Drain-Source Voltage	VDSS	-60	V
Gate-Source Voltage	VGSS	±20	V
Continuous Drain Current (TJ=150°C)	ID	TA=25°C -30.0	A
		TA=100°C -22.0	
Pulsed Drain Current	IDM	-110	A
Continuous Source Current (Diode Conduction)	IS	-30	A
Power Dissipation	PD	TA=25°C 60	W
Operation Junction Temperature		TJ	
Storage Temperature Range	TSTG	-55/150	°C
Thermal Resistance-Junction to Ambient	RθJA	25	°C/W



# STP601 / STP601D

P Channel Enhancement Mode MOSFET



-30A

## ELECTRICAL CHARACTERISTICS ( Ta = 25°C Unless otherwise noted )

Parameter	Symbol	Condition	Min	Typ	Max	Unit
<b>Static</b>						
Drain-Source Breakdown Voltage	$V_{(BR)DSS}$	$V_{GS}=0V, I_D=-250\mu A$	-60			V
Gate Threshold Voltage	$V_{GS(th)}$	$V_{DS}=V_{GS}, I_D=-250\mu A$	-1.0		-3.0	V
Gate Leakage Current	$I_{GSS}$	$V_{DS}=0V, V_{GS}=\pm 20V$			$\pm 100$	nA
Zero Gate Voltage Drain Current	$I_{DSS}$	$V_{DS}=-48V, V_{GS}=0V$			-1	uA
		$V_{DS}=-48V, V_{GS}=0V$ $T_J=55^\circ C$			-5	
On-State Drain Current	$I_{D(on)}$	$V_{DS} \cong -10V, V_{GS}=-5V$	-30			A
Drain-source On-Resistance	$R_{DS(on)}$	$V_{GS}=-10V, I_D=-20A$		20	30	mΩ
		$V_{GS}=-4.5V, I_D=-20A$		27	40	
Forward Transconductance	$g_{fs}$	$V_{DS}=-50V, I_D=-7.8A$		33		S
Diode Forward Voltage	$V_{SD}$	$I_S=-7.8A, V_{GS}=0V$			-1.2	V
<b>Dynamic</b>						
Total Gate Charge	$Q_g$	$V_{DS}=-30V, V_{GS}=-10V$ $I_D=-20A$			58	nC
Gate-Source Charge	$Q_{gs}$			23		
Gate-Drain Charge	$Q_{gd}$			10		
Input Capacitance	$C_{iss}$	$V_{DS}=-30V, V_{GS}=0V$ $F=1MHz$			3600	pF
Output Capacitance	$C_{oss}$			240		
Reverse Transfer Capacitance	$C_{rss}$			153		
Turn-On Time	$t_{d(on)}$	$V_{GS}=-10V, V_{DS}=-30V$ $R_D=3\Omega, R_G=1.5\Omega$		12		nS
	$t_r$			15		
Turn-Off Time	$t_{d(off)}$			38		
	$t_f$			15		

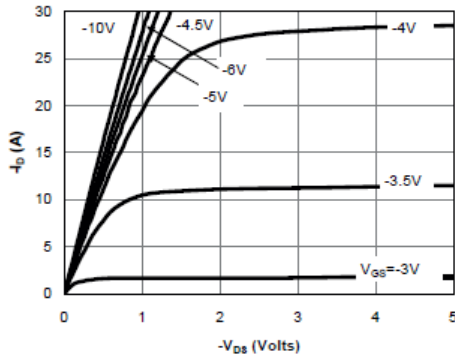
**TYPICAL CHARACTERISTICS**


Fig 1: On-Region Characteristics

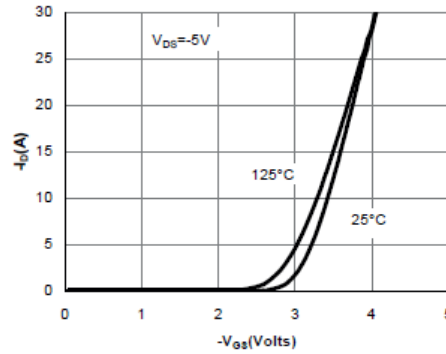


Figure 2: Transfer Characteristics

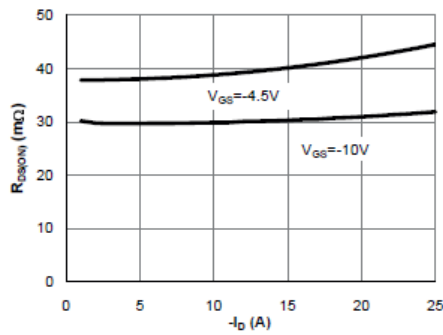


Figure 3: On-Resistance vs. Drain Current and Gate Voltage

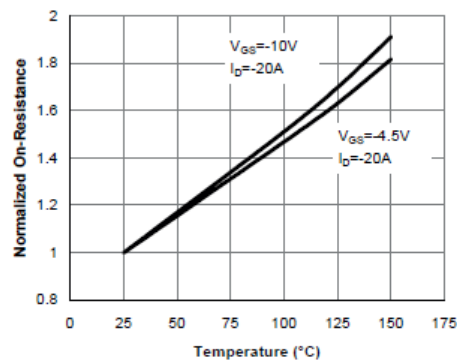


Figure 4: On-Resistance vs. Junction Temperature

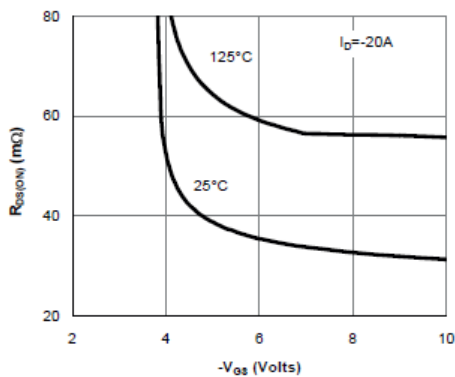


Figure 5: On-Resistance vs. Gate-Source Voltage

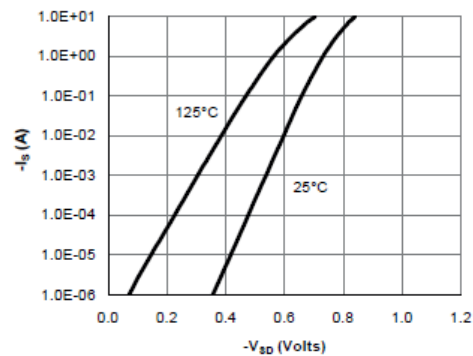
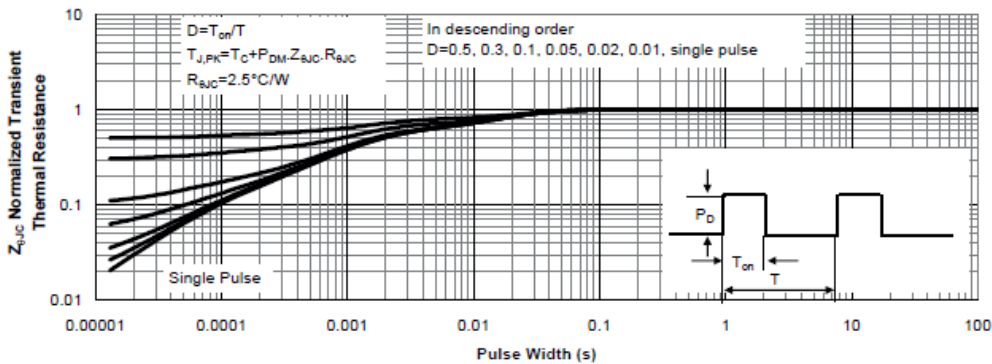
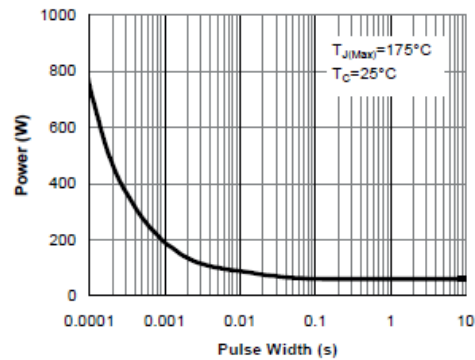
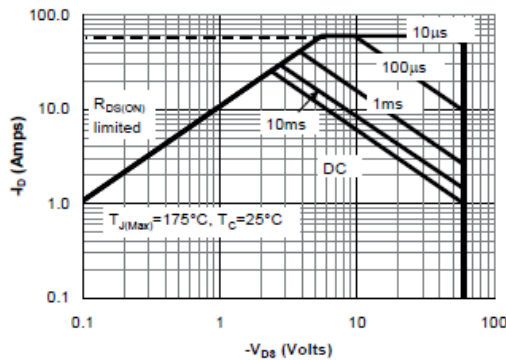
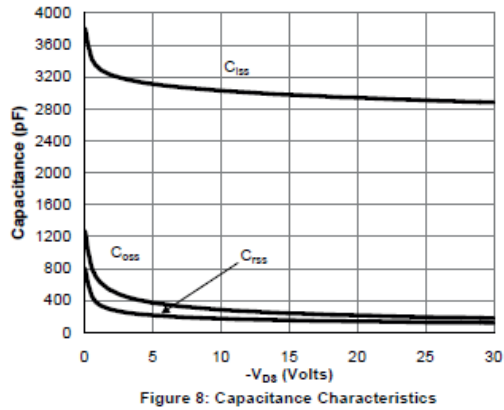
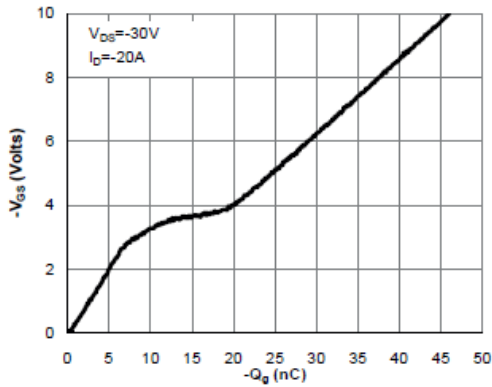
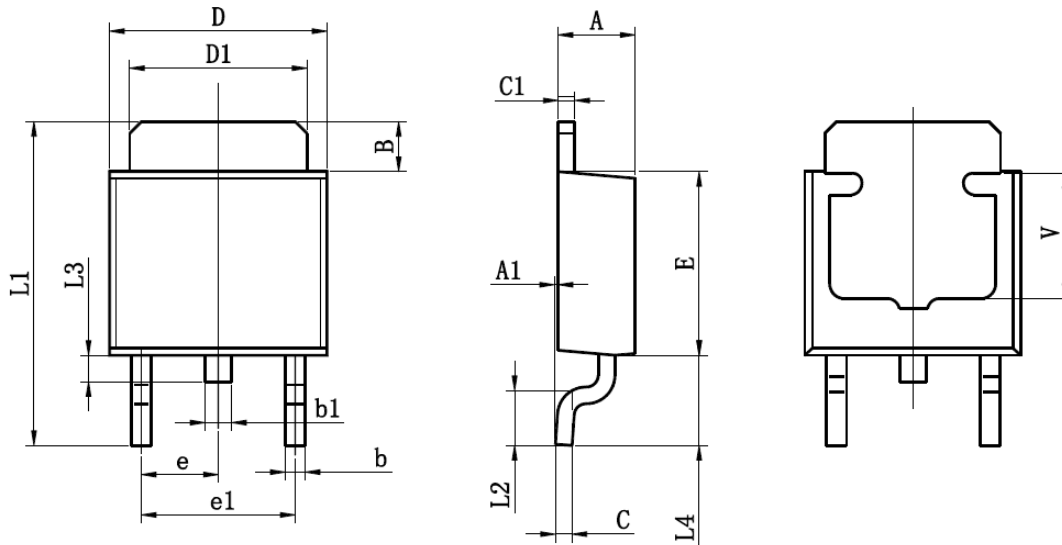
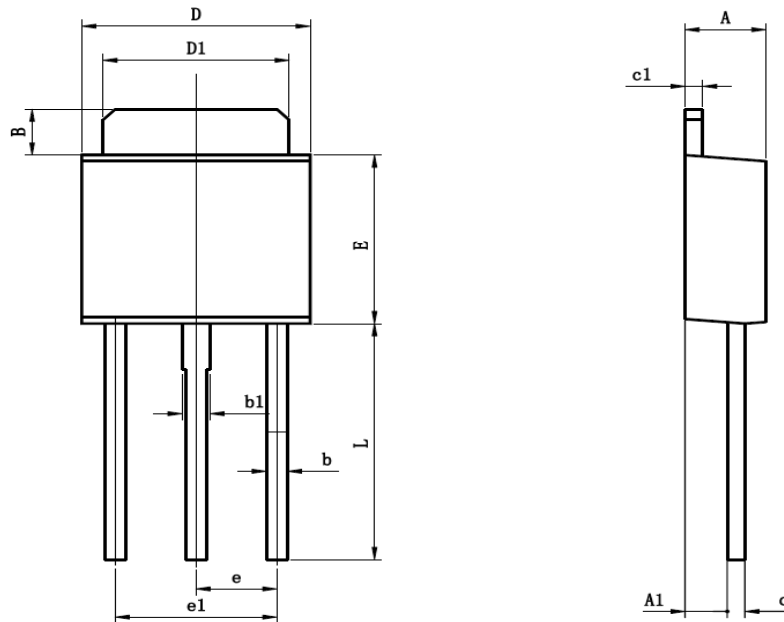


Figure 6: Body-Diode Characteristics

**TYPICAL CHARACTERISTICS**


**TO-252-2L PACKAGE OUTLINE SOP-8P**


Symbol	Dimensions In Millimeters		Dimensions In Inches	
	Min	Max	Min	Max
A	2.200	2.400	0.087	0.094
A1	0.000	0.127	0.000	0.005
B	1.350	1.650	0.053	0.065
b	0.500	0.700	0.020	0.028
b1	0.700	0.900	0.028	0.035
c	0.430	0.580	0.017	0.023
c1	0.430	0.580	0.017	0.023
D	6.350	6.650	0.250	0.262
D1	5.200	5.400	0.205	0.213
E	5.400	5.700	0.213	0.224
e	2.300TYP		0.091TYP	
e1	4.500	4.700	0.177	0.185
L1	9.500	9.900	0.374	0.390
L2	1.400	1.780	0.055	0.070
L3	0.650	0.950	0.026	0.037
L4	2.550	2.900	0.100	0.114
V	3.80REF		0.150REF	

**TO-251 PACKAGE OUTLINE SOP-8P**


Symbol	Dimensions In Millimeters		Dimensions In Inches	
	Min	Max	Min	Max
A	2.200	2.400	0.087	0.094
A1	1.020	1.270	0.040	0.050
B	1.350	1.650	0.053	0.065
b	0.500	0.700	0.020	0.028
b1	0.700	0.900	0.028	0.035
c	0.430	0.580	0.017	0.023
c1	0.430	0.580	0.017	0.023
D	6.350	6.650	0.250	0.262
D1	5.200	5.400	0.205	0.213
E	5.400	5.700	0.213	0.224
e	2.300TYP		0.091TYP	
e1	4.500	4.700	0.177	0.185
L	7.500	7.900	0.295	0.311