

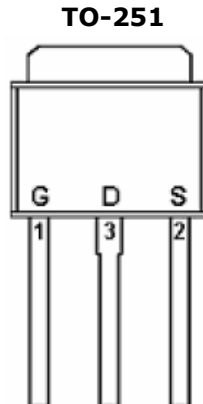

## DESCRIPTION

STP4189D is the P-Channel logic enhancement mode power field effect transistor which is produced using high cell density, DMOS trench technology. The STP413D has been designed specially to improve the overall efficiency of DC/DC converters using either synchronous or conventional switching PWM controllers. It has been optimized for low gate charge, low  $R_{DS(ON)}$  and fast switching speed.

## PIN CONFIGURATION (D-PAK)

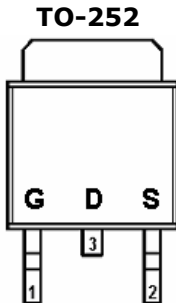

## FEATURE

- -40V/-12.0A,  $R_{DS(ON)} = 18m\Omega$  (Typ.) @ $V_{GS} = -10V$
- -40V/-8.0A,  $R_{DS(ON)} = 24m\Omega$  @ $V_{GS} = -4.5V$
- Super high density cell design for extremely low  $R_{DS(ON)}$
- Exceptional on-resistance and maximum DC current capability
- TO-252, TO-251 package design

## PART MARKING

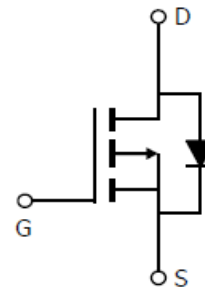
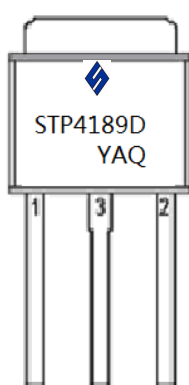
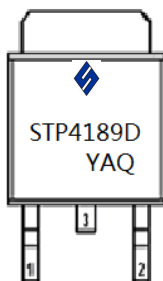

**Y: Year Code**  
**A: Week Date**  
**Q: Process Code**



**STP4189D**    
P Channel Enhancement Mode MOSFET

-12.0A

**ABSOLUTE MAXIMUM RATINGS** (Ta = 25°C Unless otherwise noted )

Parameter	Symbol	Typical	Unit
Drain-Source Voltage	VDSS	-40	V
Gate-Source Voltage	VGSS	±20	V
Pulsed Drain Current	IDM	-50	A
Continuous Source Current (Diode Conduction)	IS	-20	A
Power Dissipation	TA=25°C TA=70°C	PD 52.5 31	W
Operation Junction Temperature	TJ	150	°C
Storage Temperature Range	TSTG	-55/150	°C
Thermal Resistance-Junction to Ambient	RθJA	50	°C/W



**STP4189D**



P Channel Enhancement Mode MOSFET

-12.0A

**ELECTRICAL CHARACTERISTICS** ( Ta = 25°C Unless otherwise noted )

Parameter	Symbol	Condition	Min	Typ	Max	Unit
<b>Static</b>						
Drain-Source Breakdown Voltage	$V_{(BR)DSS}$	$V_{GS}=0V, I_D=-250\mu A$	-40			V
Gate Threshold Voltage	$V_{GS(th)}$	$V_{DS}=V_{GS}, I_D=-250\mu A$	-1.0		-3.0	V
Gate Leakage Current	$I_{GSS}$	$V_{DS}=0V, V_{GS}=\pm 20V$			$\pm 100$	nA
Zero Gate Voltage Drain Current	$I_{DSS}$	$V_{DS}=-40V, V_{GS}=0V$			-1	uA
		$V_{DS}=-40V, V_{GS}=0V$ $T_J=55^\circ C$			-5	
Drain-source On-Resistance	$R_{DS(on)}$	$V_{GS}=-10V, I_D=-12A$		18	22	mΩ
		$V_{GS}=-4.5V, I_D=-8A$		23	29	
Forward Transconductance	gfs	$V_{DS}=-5V, I_D=-12A$		23		S
Diode Forward Voltage	$V_{SD}$	$I_S=-1.0A, V_{GS}=0V$			-1.2	V
<b>Dynamic</b>						
Total Gate Charge	$Q_g$	$V_{DS}=-10V, V_{GS}=-20V$ $I_D=-12A$		31.5		nC
Gate-Source Charge	$Q_{gs}$			7.8		
Gate-Drain Charge	$Q_{gd}$			6.5		
Input Capacitance	$C_{iss}$	$V_{DS}=-20V, V_{GS}=0V$ $F=1MHz$		1870		pF
Output Capacitance	$C_{oss}$			185		
Reverse Transfer Capacitance	$C_{rss}$			155		
Turn-On Time	$t_{d(on)}$	$V_{GS}=-10V, V_{DS}=-20V$ $R_L=1.6\Omega, R_{GEN}=3\Omega$		10		nS
	$t_r$			18		
Turn-Off Time	$t_{d(off)}$			38		
	$t_f$			25		

**TYPICAL CHARACTERISTICS**

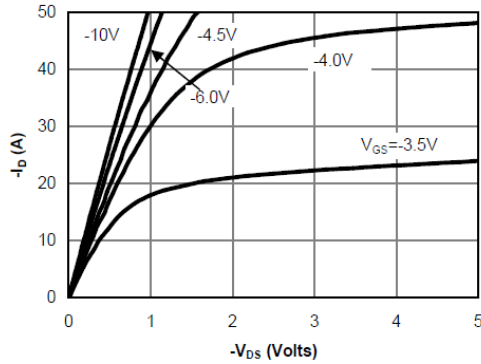

Figure 1: On-Region Characteristics

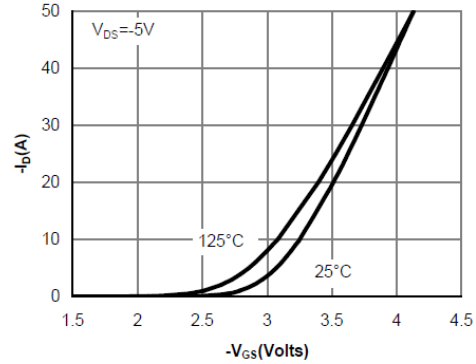

Figure 2: Transfer Characteristics

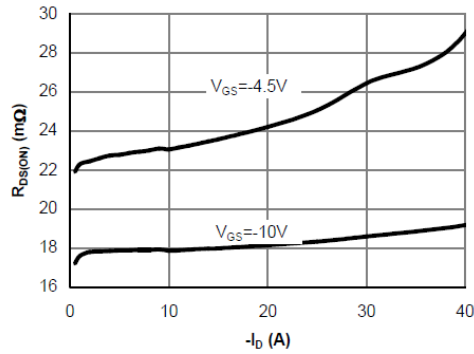

Figure 3: On-Resistance vs. Drain Current and Gate Voltage

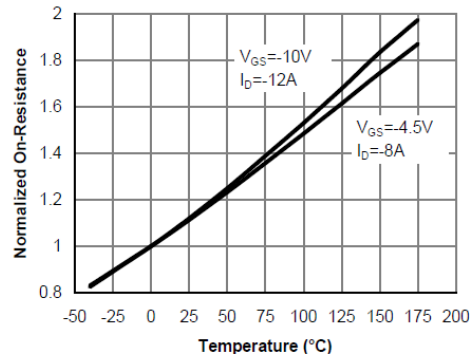

Figure 4: On-Resistance vs. Junction Temperature

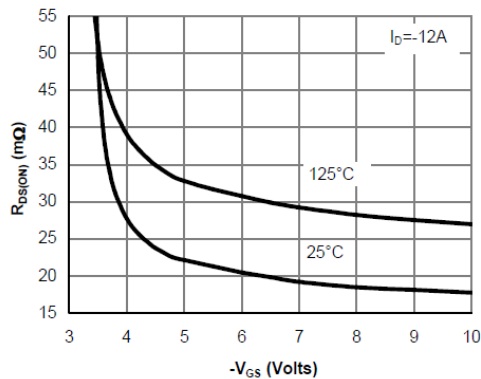

Figure 5: On-Resistance vs. Gate-Source Voltage

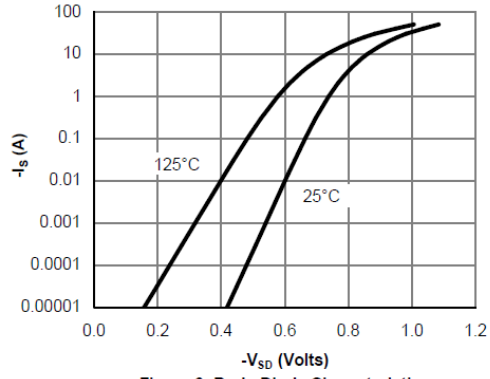

Figure 6: Body-Diode Characteristics

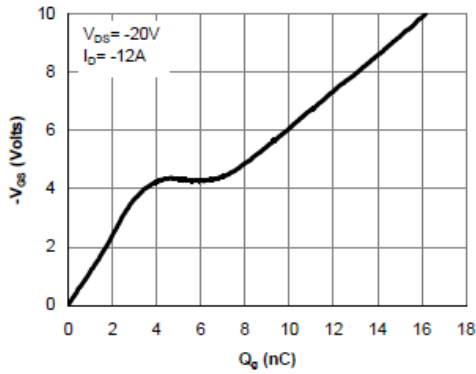

Figure 7: Gate-Charge Characteristics

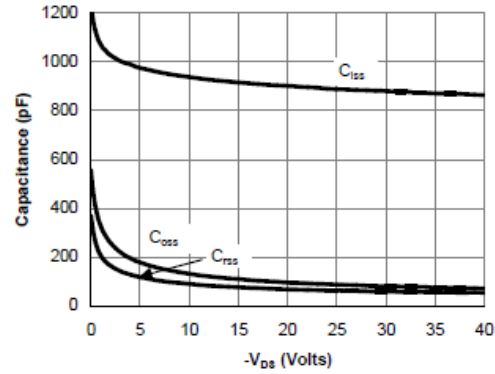

Figure 8: Capacitance Characteristics

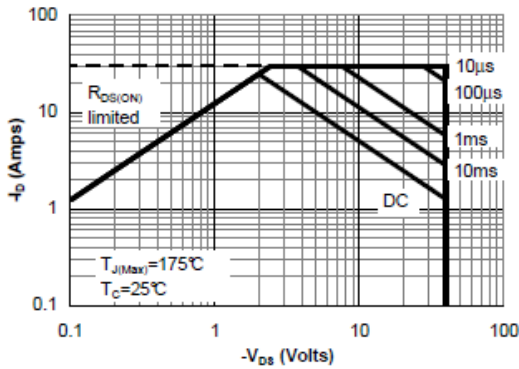

Figure 9: Maximum Forward Biased Safe Operating Area (Note F)

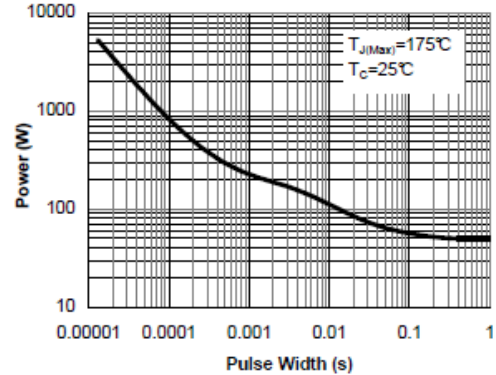

Figure 10: Single Pulse Power Rating Junction-to-Case (Note F)

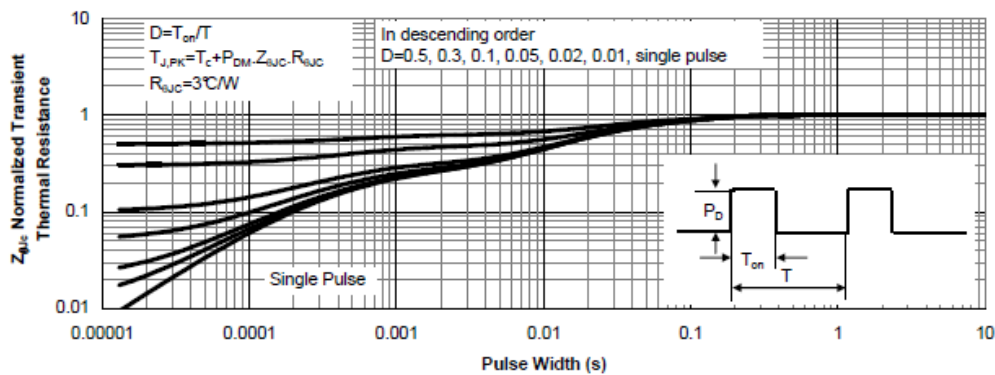

Figure 11: Normalized Maximum Transient Thermal Impedance (Note F)

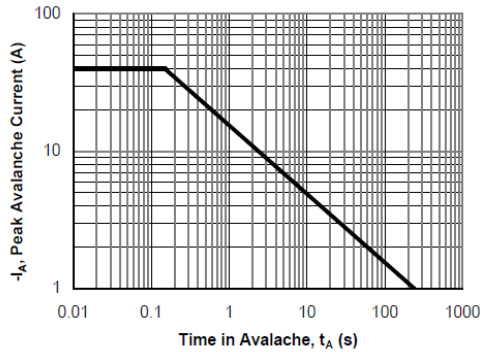

Figure 12: Single Pulse Avalanche Capability

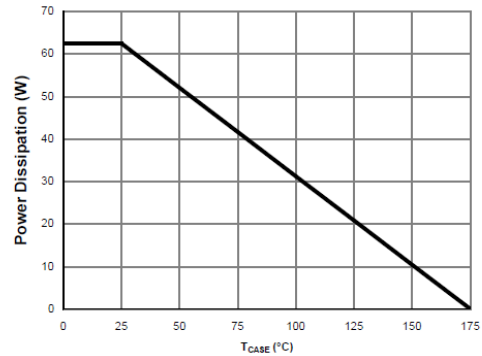

Figure 13: Power De-rating (Note B)

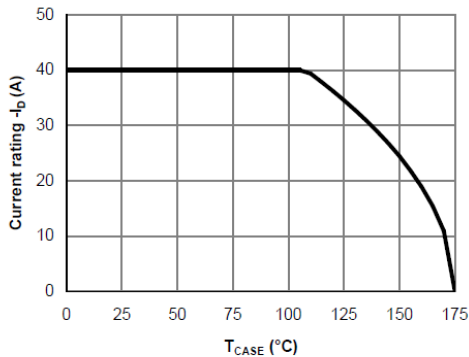

Figure 14: Current De-rating (Note B)

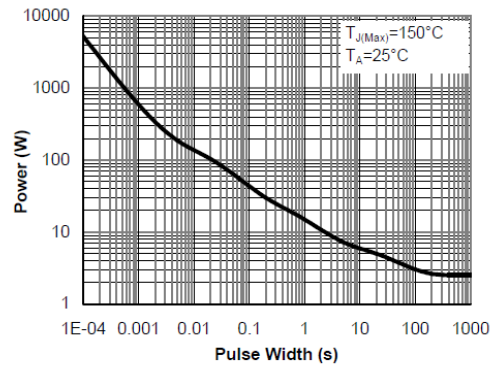

Figure 15: Single Pulse Power Rating Junction-to-Ambient (Note G)

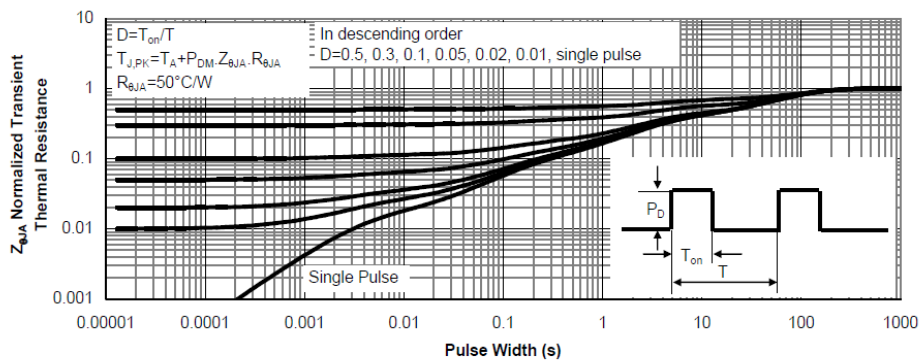
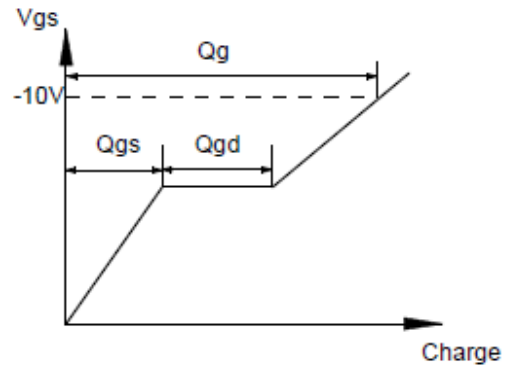
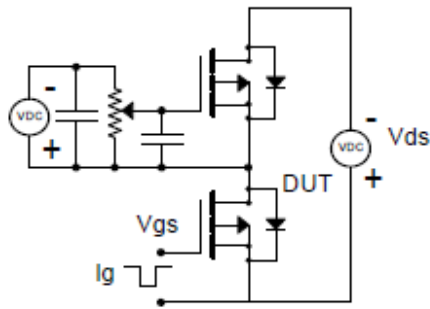
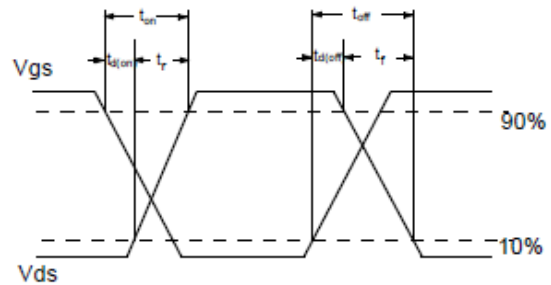
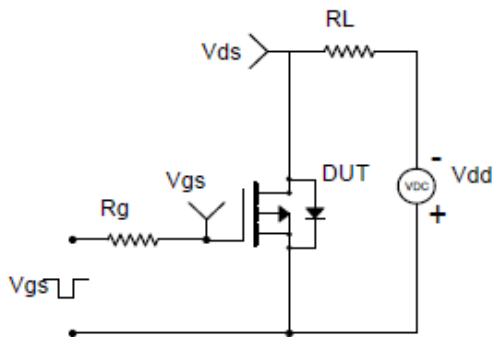

Figure 16: Normalized Maximum Transient Thermal Impedance (Note G)

**GATE CHARGE TEST CIRCUIT & WAVEFORM**



**RESISTIVE SWITCHING TEST CIRCUIT & WAVEFORMS**



**UNCLAMPED INDUCTIVE SWITCHING (UIS) TEST CIRCUIT & WAVEFORMS**

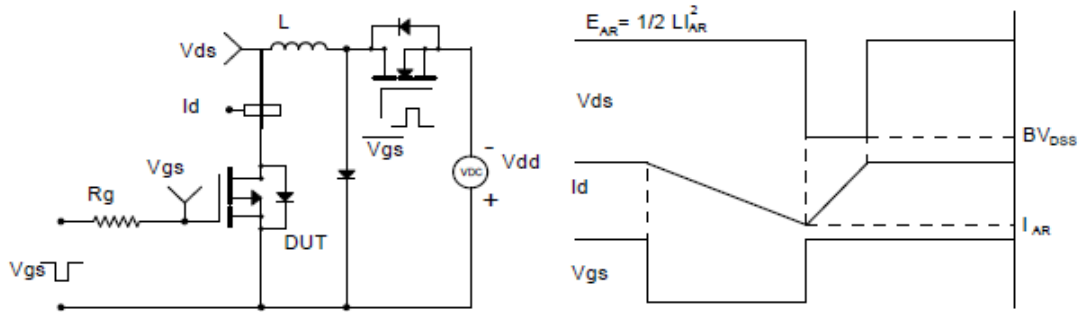

**DIODE RECOVERY TEST CIRCUIT & WAVEFORMS**

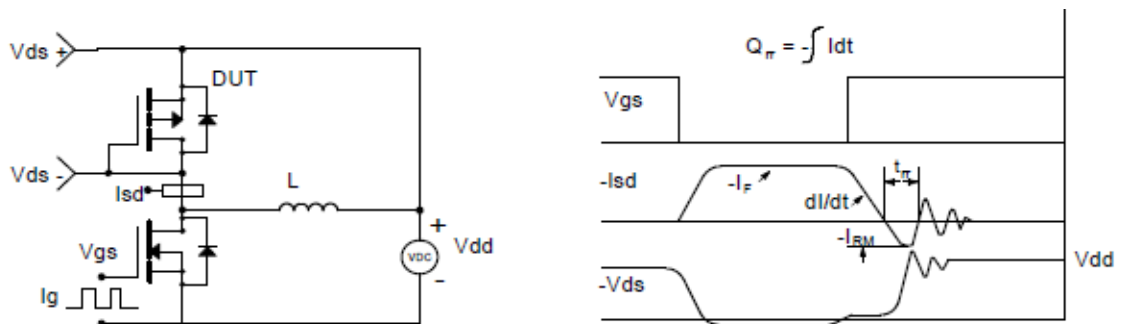





-12.0A

**TO-252-2L PACKAGE OUTLINE SOP-8P**

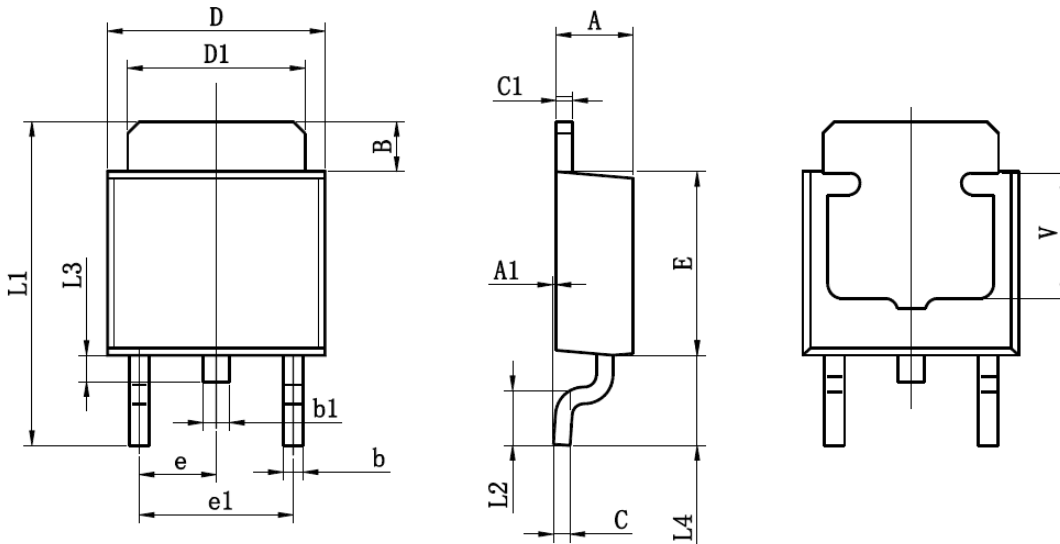

Symbol	Dimensions In Millimeters		Dimensions In Inches	
	Min	Max	Min	Max
A	2.200	2.400	0.087	0.094
A1	0.000	0.127	0.000	0.005
B	1.350	1.650	0.053	0.065
b	0.500	0.700	0.020	0.028
b1	0.700	0.900	0.028	0.035
c	0.430	0.580	0.017	0.023
c1	0.430	0.580	0.017	0.023
D	6.350	6.650	0.250	0.262
D1	5.200	5.400	0.205	0.213
E	5.400	5.700	0.213	0.224
e	2.300TYP		0.091TYP	
e1	4.500	4.700	0.177	0.185
L1	9.500	9.900	0.374	0.390
L2	1.400	1.780	0.055	0.070
L3	0.650	0.950	0.026	0.037
L4	2.550	2.900	0.100	0.114
V	3.80REF		0.150REF	