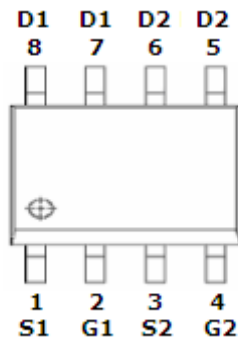

DESCRIPTION

The STN4946 is the Dual N-Channel logic enhancement mode power field effect transistors are produced using high cell density , DMOS trench technology. This high density process is especially tailored to minimize on-state resistance. These devices are particularly suited for low voltage application , notebook computer Li-ion Battery , power management and other battery powered circuits where high-side switching .

**PIN CONFIGURATION
SOP-8**

FEATURE

- 60V/12A, $R_{DS(ON)} = 44m\Omega$ (Typ.) @VGS = 10V
- 60V/8.0A, $R_{DS(ON)} = 50m\Omega$ @VGS = 4.5V
- Super high density cell design for extremely low $R_{DS(ON)}$
- Exceptional on-resistance and maximum DC current capability
- SOP-8 package design

**PART MARKING
SOP-8**

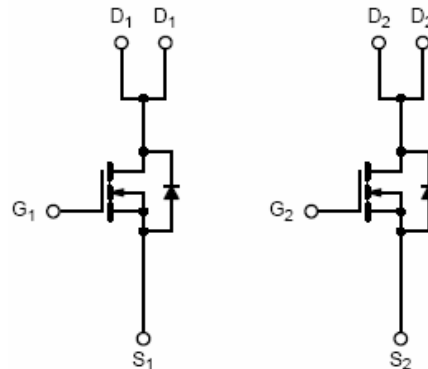
Y: Year Code A: Process Code





STN4946 

Dual N Channel Enhancement Mode MOSFET
12A

ABSOLUTE MAXIMUM RATINGS (Ta = 25°C Unless otherwise noted)

| Parameter | Symbol | Typical | Unit |
|---|------------------|-----------------------------|------|
| Drain-Source Voltage | V _{DSS} | 60 | V |
| Gate-Source Voltage | V _{GSS} | ±20 | V |
| Continuous Drain Current (T _J =150°C) | I _D | T _A =25°C 8.0 | A |
| | | T _A =70°C 6.0 | |
| Pulsed Drain Current | I _{DM} | 30 | A |
| Continuous Source Current (Diode Conduction) | I _S | 11 | A |
| Power Dissipation | P _D | T _A =25°C 2.5 | W |
| | | T _A =70°C 1.6 | |
| Operation Junction Temperature | T _J | -55/150 | °C |
| Storage Temperature Range | T _{STG} | -55/150 | °C |
| Thermal Resistance-Junction to Ambient | R _{θJA} | 80 | °C/W |

ELECTRICAL CHARACTERISTICS (Ta = 25°C Unless otherwise noted)

| Parameter | Symbol | Condition | Min | Typ | Max | Unit |
|---------------------------------|-------------------------------|---|-----|-------|-----------|----------|
| Static | | | | | | |
| Drain-Source Breakdown Voltage | $V_{(BR)DSS}$ | $V_{GS}=0V, I_D=250\mu A$ | 60 | | | V |
| Gate Threshold Voltage | $V_{GS(th)}$ | $V_{DS}=V_{GS}, I_D=250\mu A$ | 0.8 | | 2.0 | V |
| Gate Leakage Current | I_{GSS} | $V_{DS}=0V, V_{GS}=\pm 20V$ | | | ± 100 | nA |
| Zero Gate Voltage Drain Current | I_{DSS} $T_J=85^\circ C$ | $V_{DS}=60V, V_{GS}=0V$ | | | 1 | uA |
| | | $V_{DS}=60V, V_{GS}=0V$ | | | 5 | |
| On-State Drain Current | $I_{D(on)}$ | $V_{DS}\leq 5V, V_{GS}=10V$ | 30 | | | A |
| Drain-source On-Resistance | $R_{DS(on)}$ | $V_{GS}=10V, I_D=10A$ | | 0.038 | 0.044 | Ω |
| | | $V_{GS}=4.5V, I_D=6A$ | | 0.042 | 0.050 | |
| Forward Tran Conductance | g_{fs} | $V_{DS}=15V, I_D=5.3A$ | | 24 | | S |
| Diode Forward Voltage | V_{SD} | $I_S=2.0A, V_{GS}=0V$ | | 0.8 | 1.2 | V |
| Dynamic | | | | | | |
| Total Gate Charge | Q_g | $V_{DS}=30V, V_{GS}=10V$ $I_D=5.3A$ | | 10 | 15 | nC |
| Gate-Source Charge | Q_{gs} | | | 3.5 | | |
| Gate-Drain Charge | Q_{gd} | | | 3.6 | | |
| Input Capacitance | C_{iss} | $V_{DS}=15V, V_{GS}=0V$ $f=1MHz$ | | 890 | | pF |
| Output Capacitance | C_{oss} | | | 85 | | |
| Reverse Transfer Capacitance | C_{rss} | | | 48 | | |
| Turn-On Time | $t_{d(on)}$ t_r | $V_{DD}=30V, R_L=6.8\Omega$ $I_D=4.4A, V_{GEN}=10V$ $R_G=1\Omega$ | | 10 | 15 | nS |
| | | | | 12 | 20 | |
| Turn-Off Time | $t_{d(off)}$ t_f | | | 25 | 35 | |
| | | | | 10 | 15 | |

TYPICAL CHARACTERISTICS (25°C Unless Note)

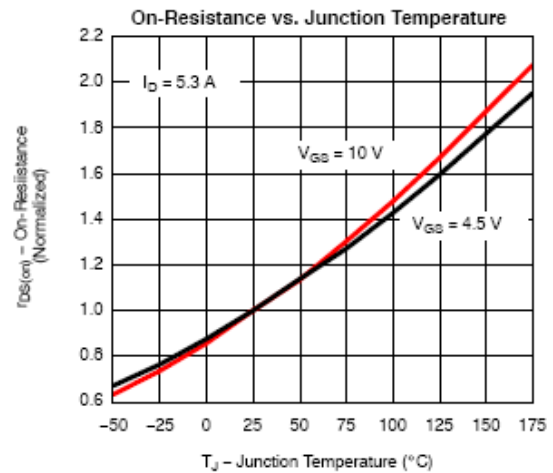
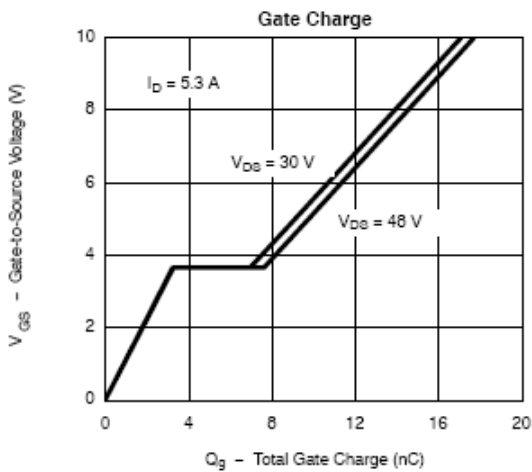
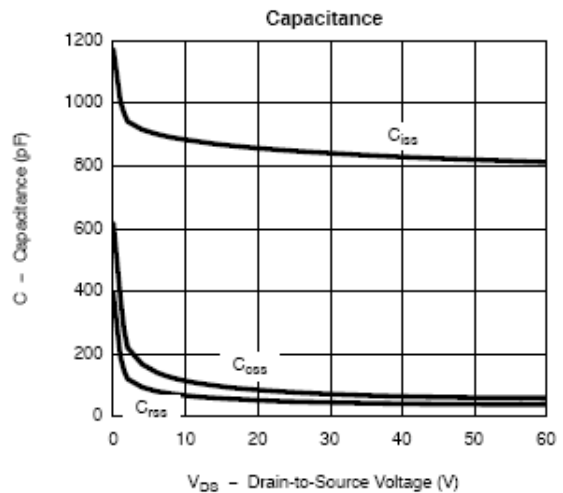
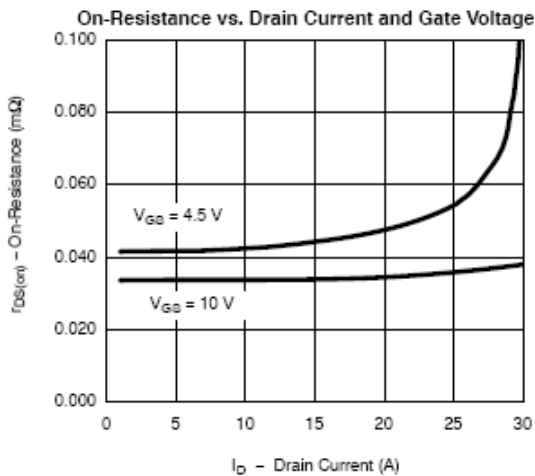
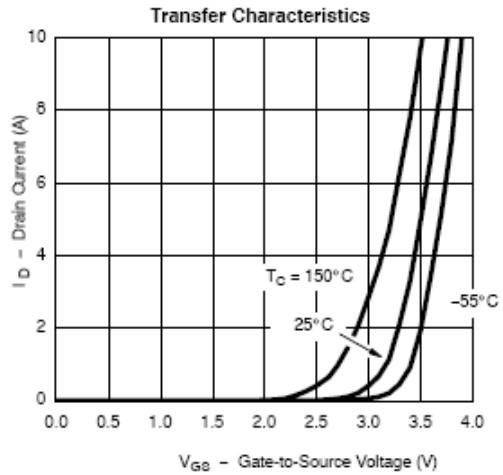
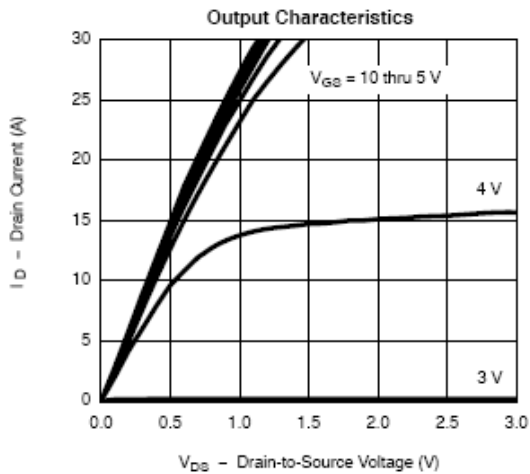

TYPICAL CHARACTERISTICS (25°C Unless Note)

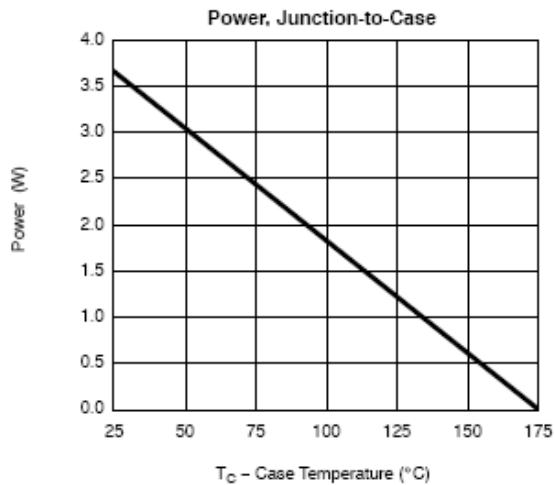
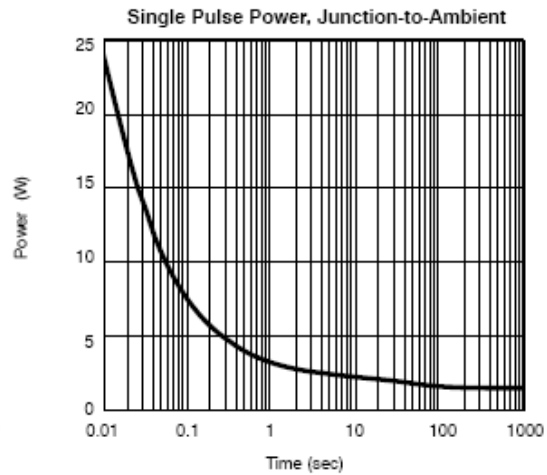
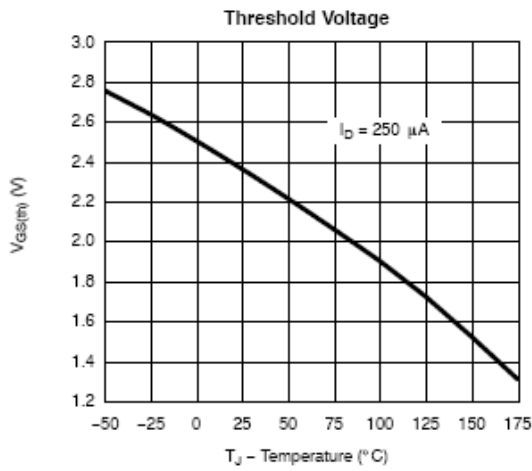
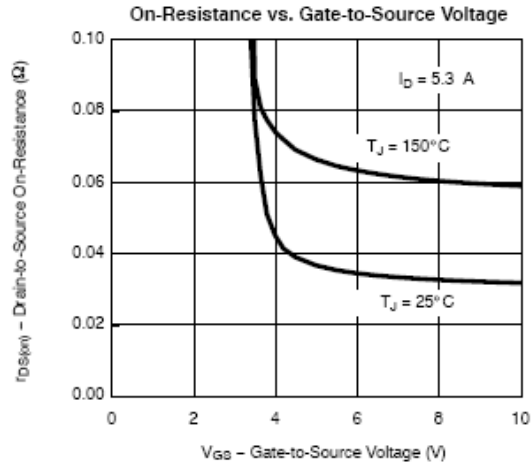
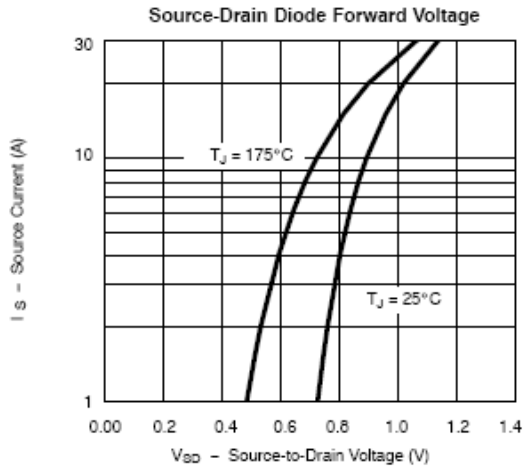

TYPICAL CHARACTERISTICS (25°C Unless Note)

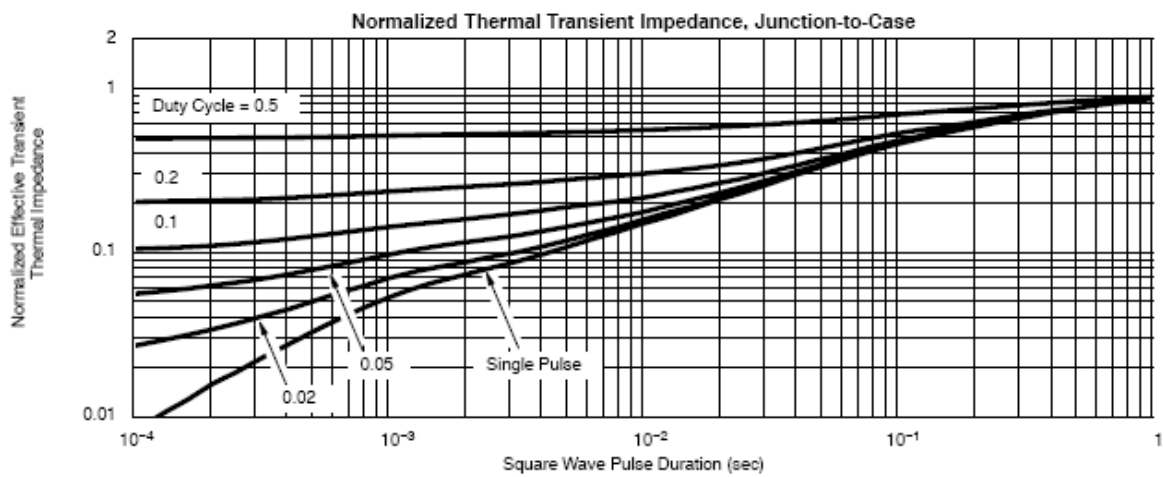
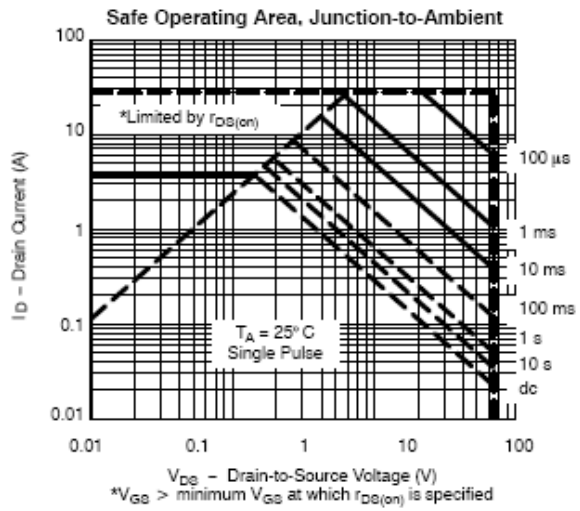
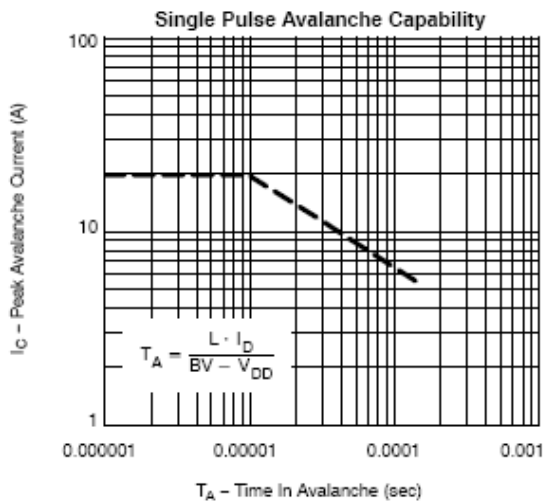

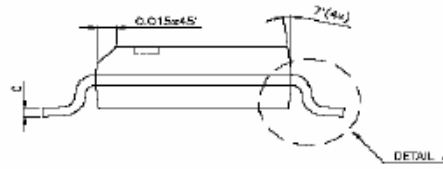
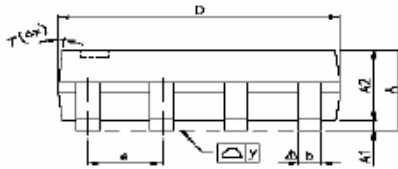
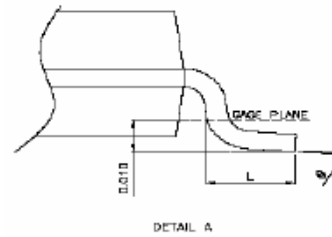
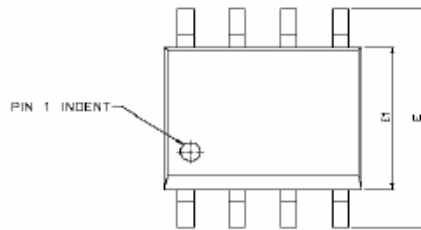
SOP-8 PACKAGE OUTLINE

| SYMBOLS | DIMENSIONS IN MILLIMETERS | | | DIMENSIONS IN INCHES | | |
|---------------|---------------------------|------|-------|----------------------|-------|--------|
| | MIN | NOM | MAX | MIN | NOM | MAX |
| A | 1.47 | 1.60 | 1.73 | 0.058 | 0.063 | 0.068 |
| A1 | 0.10 | — | 0.25 | 0.004 | — | 0.010 |
| A2 | — | 1.45 | — | — | 0.057 | — |
| b | 0.33 | 0.41 | 0.51 | 0.013 | 0.016 | 0.020 |
| C | 0.19 | 0.20 | 0.25 | 0.0075 | 0.008 | 0.0098 |
| D | 4.80 | 4.85 | 4.95 | 0.189 | 0.191 | 0.195 |
| E | 5.80 | 6.00 | 6.20 | 0.228 | 0.236 | 0.244 |
| E1 | 3.80 | 3.90 | 4.00 | 0.150 | 0.154 | 0.157 |
| e | — | 1.27 | — | — | 0.050 | — |
| L | 0.38 | 0.71 | 1.27 | 0.015 | 0.028 | 0.050 |
| Δ y | — | — | 0.076 | — | — | 0.003 |
| \varnothing | 0* | — | 8* | 0* | — | 8* |