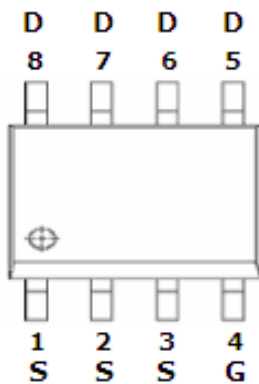
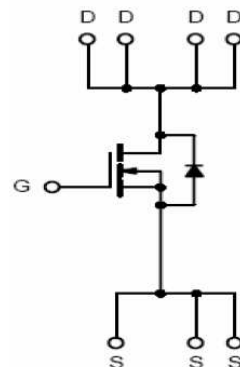
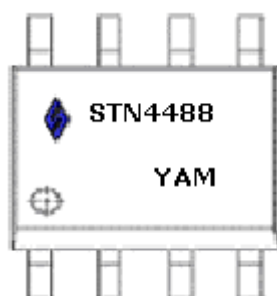

DESCRIPTION

STN4488L is the N-Channel logic enhancement mode power field effect transistors which are produced using high cell density DMOS trench technology. It is suitable for the power management applications in the portable or battery powered system.

**PIN CONFIGURATION
SOP-8**

FEATURE

- 30V/20A, $R_{DS(ON)} = 3.8m\Omega$ (Typ.) @VGS = 10V
- 30V/18A, $R_{DS(ON)} = 5.2m\Omega$ @VGS = 4.5V
- Super high density cell design for extremely low $R_{DS(ON)}$
- Exceptional on-resistance and maximum DC current capability
- SOP-8 package design

**PART MARKING
SOP-8**

Y: Year Code
A: Week Code
M: Process Code



STN4488L 

N Channel Enhancement Mode MOSFET
20.0A

ABSOLUTE MAXIMUM RATINGS (Ta = 25°C Unless otherwise noted)

Parameter		Symbol	10 Sec	Steady state	Unit
Drain-Source Voltage		V _{DSS}	30		V
Gate-Source Voltage		V _{GSS}	±20		V
Continuous Drain Current (T _J =150°C)	T _A =25°C	I _D	20	15	A
	T _A =70°C		17	12	
Pulsed Drain Current		I _{DM}	80		A
Continuous Source Current (Diode Conduction)		I _S	3.0		A
Power Dissipation	T _A =25°C	P _D	3.1	1.7	W
	T _A =70°C		20	1.1	
Operation Junction Temperature		T _J	-55/150		°C
Storage Temperature Range		T _{STG}	-55/150		°C
Thermal Resistance-Junction to Ambient		R _{θJA}	Typ	Max	°C/W
			59	75	



STN4488L



N Channel Enhancement Mode MOSFET
20.0A

ELECTRICAL CHARACTERISTICS (Ta = 25°C Unless otherwise noted)

Parameter	Symbol	Condition	Min	Typ	Max	Unit
Static						
Drain-Source Breakdown Voltage	$V_{(BR)DSS}$	$V_{GS}=0V, I_D=250\mu A$	30			V
Gate Threshold Voltage	$V_{GS(th)}$	$V_{DS}=V_{GS}, I_D=250\mu A$	1.0		2.5	V
Gate Leakage Current	I_{GSS}	$V_{DS}=0V, V_{GS}=\pm 20V$			± 10	nA
Zero Gate Voltage Drain Current	I_{DSS}	$V_{DS}=30V, V_{GS}=0V$ $T_J=55^\circ C$			1	uA
					5	
On-State Drain Current	$I_{D(on)}$	$V_{DS}=5V, V_{GS}=10V$	80			A
Drain-source On-Resistance	$R_{DS(on)}$	$V_{GS}=10V, I_D=20A$ $T_J=125^\circ C$		3.8	4.6	mΩ
					5.3	
		$V_{GS}=4.5V, I_D=18A$		5.2	6.4	
Forward Tran Conductance	g_{fs}	$V_{DS}=10V, I_D=20A$		72		S
Diode Forward Voltage	V_{SD}	$I_S=8.0A, V_{GS}=0V$			1.0	V
Dynamic						
Total Gate Charge	Q_g	$V_{DS}=15V, V_{GS}=10V$ $I_D=20A$		84	112	nC
Gate-Source Charge	Q_{gs}			12		
Gate-Drain Charge	Q_{gd}			21		
Input Capacitance	C_{iss}	$V_{DS}=15V, V_{GS}=0V$ $f=1MHz$		5450	6800	pF
Output Capacitance	C_{oss}			760		
Reverse TransferCapacitance	C_{rss}			540		
Turn-On Time	$t_{d(on)}$	$V_{DS}=15V, R_L=0.75\Omega$ $I_D=1A, V_G=10V$ $R_G=3.0\Omega$		13		nS
	t_r			9.8		
Turn-Off Time	$t_{d(off)}$			49		
	t_f			16		

TYPICAL CHARACTERISTICS

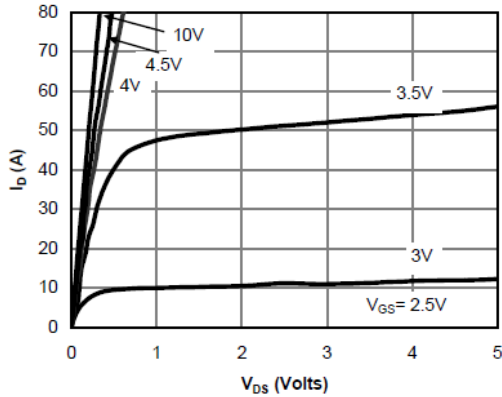

Figure 1: On-Region Characteristics

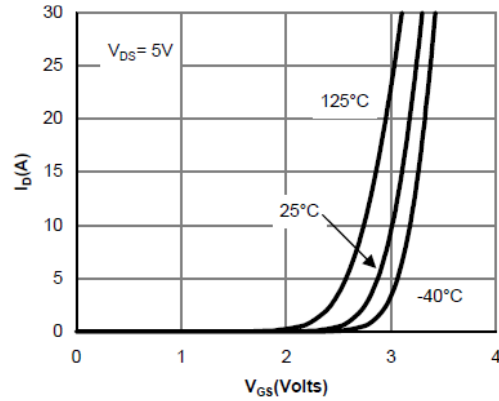

Figure 2: Transfer Characteristics

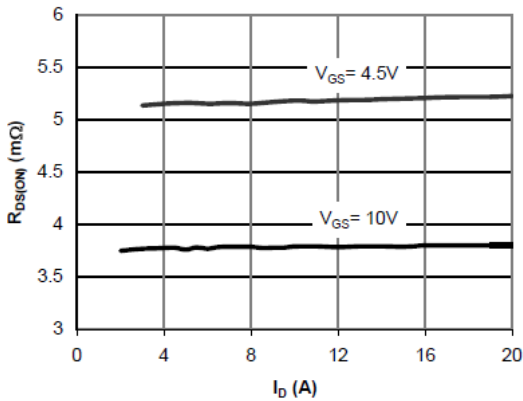

Figure 3: On-Resistance vs. Drain Current and Gate Voltage

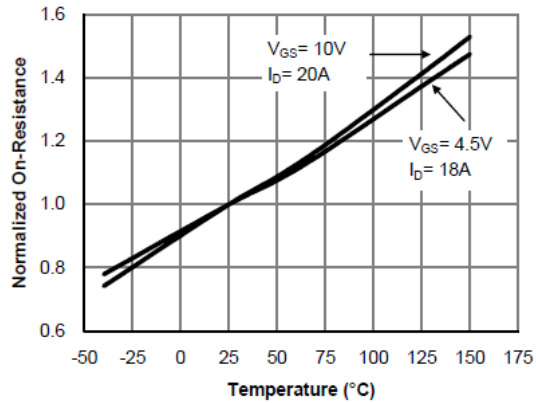

Figure 4: On-Resistance vs. Junction Temperature

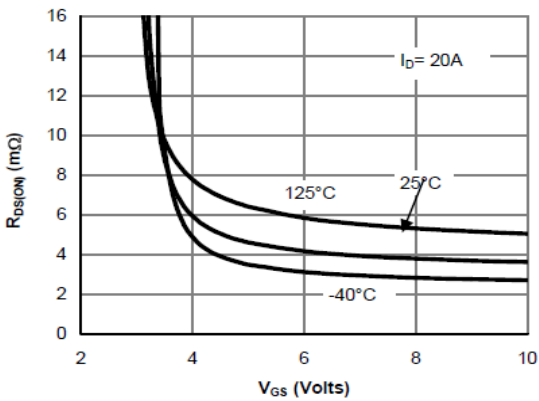

Figure 5: On-Resistance vs. Gate-Source Voltage

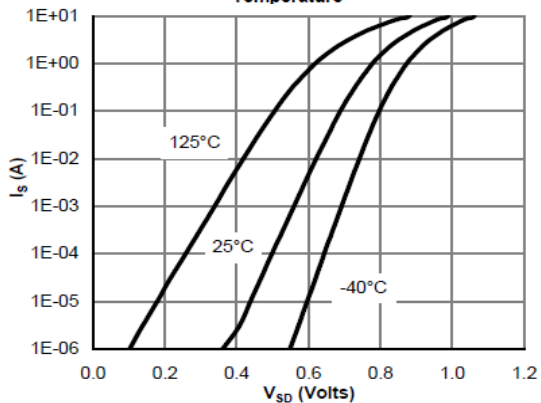

Figure 6: Body-Diode Characteristics

TYPICAL CHARACTERISTICS

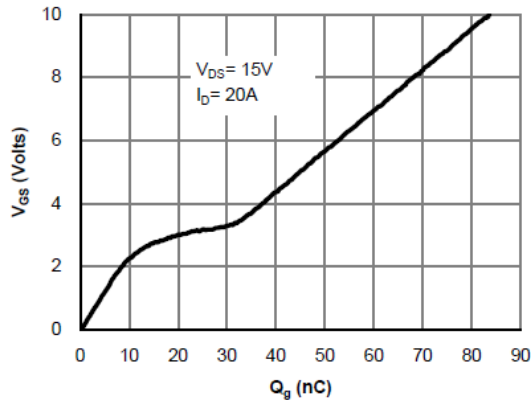

Figure 7: Gate-Charge Characteristics

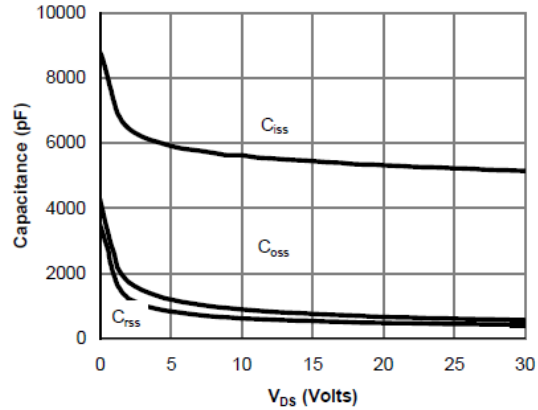

Figure 8: Capacitance Characteristics

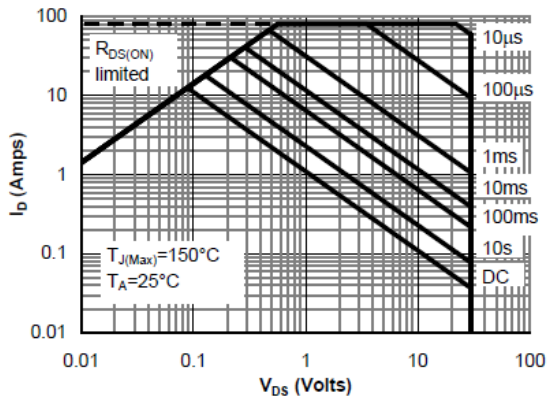

Figure 9: Maximum Forward Biased Safe Operating Area (Note E)

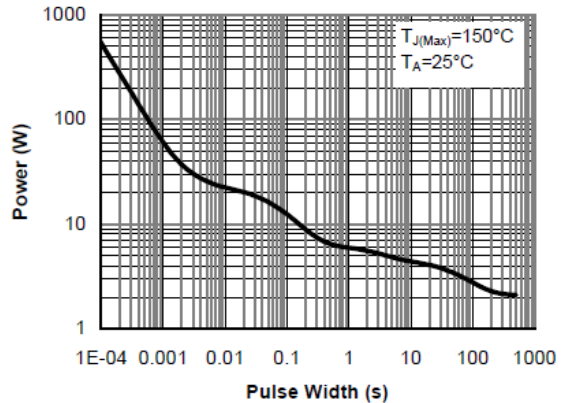

Figure 10: Single Pulse Power Rating Junction-to-Ambient (Note E)

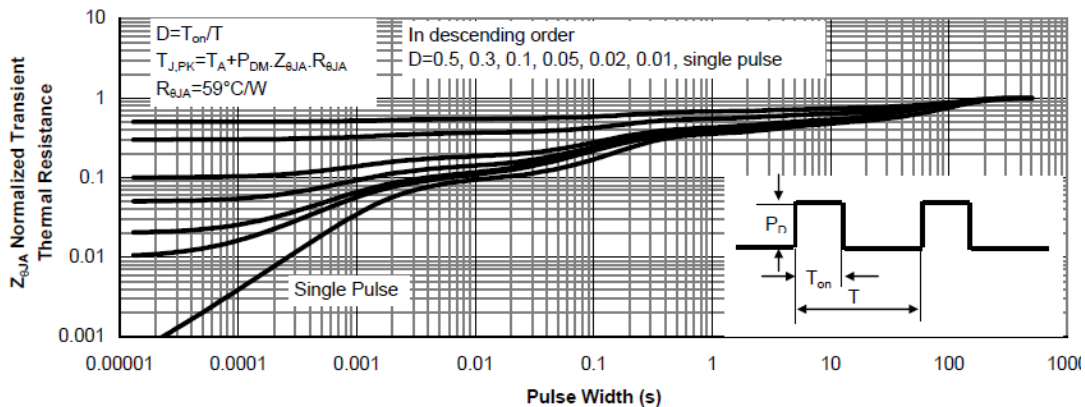
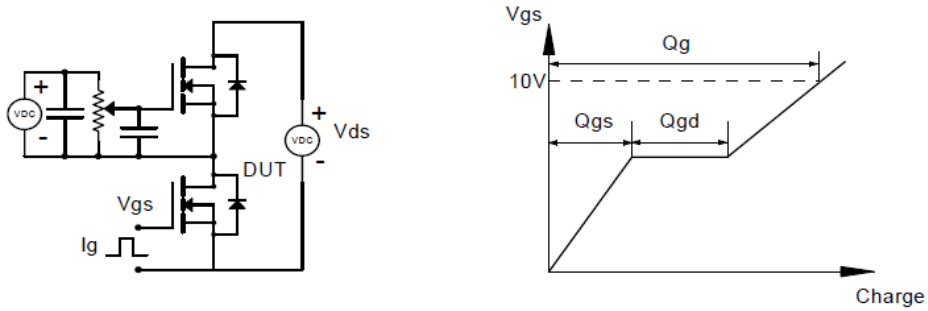
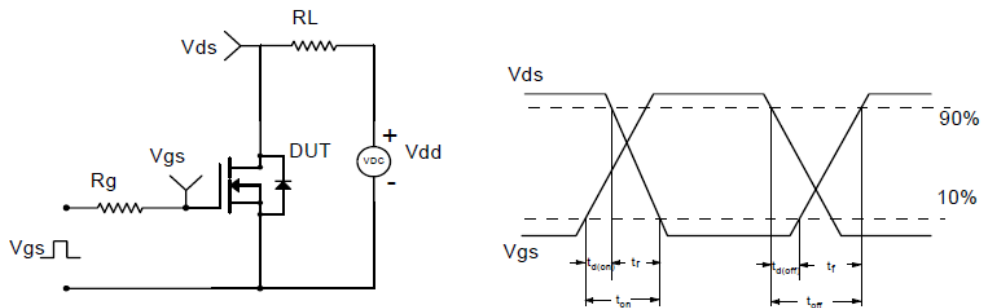

Figure 11: Normalized Maximum Transient Thermal Impedance (Note E)

Gate Charge Test Circuit & Waveform



Resistive Switching Test Circuit & Waveforms



Unclamped Inductive Switching (UIS) Test Circuit & Waveforms

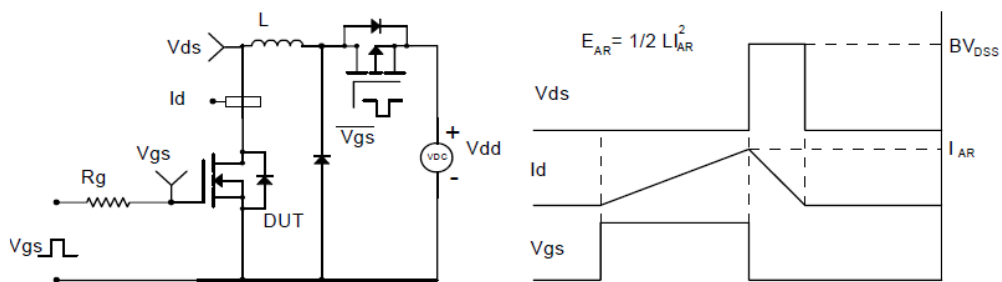

Diode Recovery Test Circuit & Waveforms

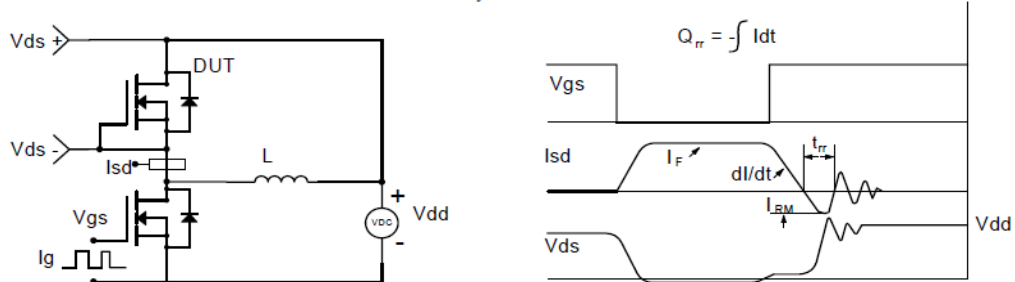

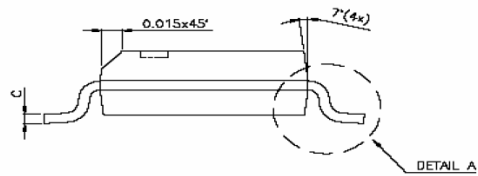
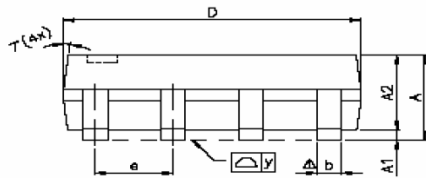
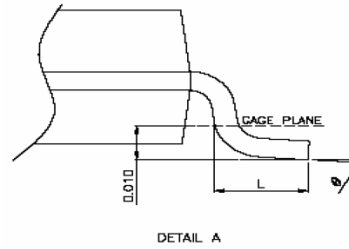
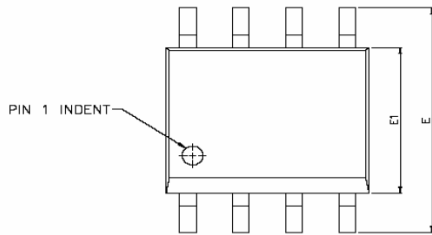
SOP-8 PACKAGE OUTLINE

SYMBOLS	DIMENSIONS IN MILLIMETERS			DIMENSIONS IN INCHES		
	MIN	NOM	MAX	MIN	NOM	MAX
A	1.47	1.60	1.73	0.058	0.063	0.068
A1	0.10	—	0.25	0.004	—	0.010
A2	—	1.45	—	—	0.057	—
b	0.33	0.41	0.51	0.013	0.016	0.020
C	0.19	0.20	0.25	0.0075	0.008	0.0098
D	4.80	4.85	4.95	0.189	0.191	0.195
E	5.80	6.00	6.20	0.228	0.236	0.244
E1	3.80	3.90	4.00	0.150	0.154	0.157
e	—	1.27	—	—	0.050	—
L	0.38	0.71	1.27	0.015	0.028	0.050
Δ y	—	—	0.076	—	—	0.003
\varnothing	0°	—	8°	0°	—	8°