

Features

- 40V/90A,
 $R_{DS(ON)} = 4m$ (Typ.) @ $V_{GS} = 10V$
- Super High Dense Cell Design
- Ultra Low On-Resistance
- 100% avalanche tested
- Lead Free and Green Devices Available
 (RoHS Compliant)

Applications

- Motor Drivers
- Switch Systems

Pin Description

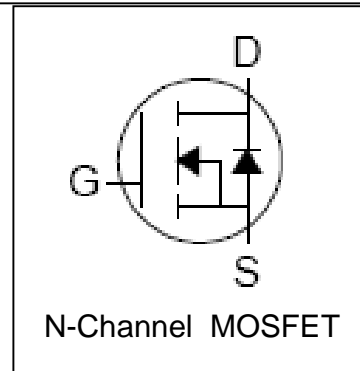
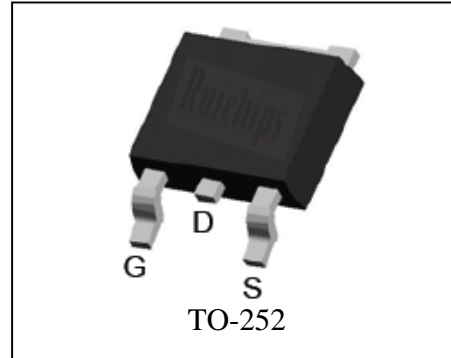

Absolute Maximum Ratings

| Symbol | Parameter | Rating | Unit |
|--|---|--|--------------|
| Common Ratings ($T_C = 25^\circ C$ Unless Otherwise Noted) | | | |
| V_{DSS} | Drain-Source Voltage | 40 | V |
| V_{GSS} | Gate-Source Voltage | ± 20 | |
| T_J | Maximum Junction Temperature | 175 | $^\circ C$ |
| T_{STG} | Storage Temperature Range | -55 to 175 | $^\circ C$ |
| I_S | Diode Continuous Forward Current | $T_C = 25^\circ C$ 90 ^① | A |
| Mounted on Large Heat Sink | | | |
| I_{DP} | 300 μs Pulse Drain Current Tested | $T_C = 25^\circ C$ 360 ^② | A |
| I_D | Continuous Drain Current ($V_{GS} = 10V$) | $T_C = 25^\circ C$ 90 ^① | A |
| | | $T_C = 100^\circ C$ 73 ^① | |
| P_D | Maximum Power Dissipation | $T_C = 25^\circ C$ 107 | W |
| | | $T_C = 100^\circ C$ 53.5 | W |
| $R_{\theta JC}$ | Thermal Resistance-Junction to Case | 1.4 | $^\circ C/W$ |
| Drain-Source Avalanche Ratings | | | |
| E_{AS} ^③ | Avalanche Energy, Single Pulsed | 380 | mJ |

Electrical Characteristics ($T_C=25^\circ\text{C}$ Unless Otherwise Noted)

| Symbol | Parameter | Test Condition | RU4090L | | | Unit |
|---|----------------------------------|---|---------|------|-----------|------------|
| | | | Min. | Typ. | Max. | |
| Static Characteristics | | | | | | |
| BV_{DSS} | Drain-Source Breakdown Voltage | $V_{GS}=0V, I_{DS}=250\mu A$ | 40 | | | V |
| I_{DSS} | Zero Gate Voltage Drain Current | $V_{DS}=40V, V_{GS}=0V$ $T_J=85^\circ\text{C}$ | | | 1 30 | μA |
| $V_{GS(th)}$ | Gate Threshold Voltage | $V_{DS}=V_{GS}, I_{DS}=250\mu A$ | 2 | 3 | 4 | V |
| I_{GSS} | Gate Leakage Current | $V_{GS}=\pm 20V, V_{DS}=0V$ | | | ± 100 | nA |
| $R_{DS(ON)}^{(4)}$ | Drain-Source On-state Resistance | $V_{GS}=10V, I_{DS}=45A$ | | 4 | 5 | m Ω |
| Diode Characteristics | | | | | | |
| $V_{SD}^{(4)}$ | Diode Forward Voltage | $I_{SD}=45A, V_{GS}=0V$ | | | 1.2 | V |
| t_{rr} | Reverse Recovery Time | $I_{SD}=45A, di_{SD}/dt=100A/\mu s$ | | 39 | | ns |
| Q_{rr} | Reverse Recovery Charge | | | 46 | | nC |
| Dynamic Characteristics ⁽⁵⁾ | | | | | | |
| R_G | Gate Resistance | $V_{GS}=0V, V_{DS}=0V, F=1\text{MHz}$ | | 1.8 | | Ω |
| C_{iss} | Input Capacitance | $V_{GS}=0V,$ $V_{DS}=20V,$ Frequency=1.0MHz | | 3250 | | pF |
| C_{oss} | Output Capacitance | | | 360 | | |
| C_{riss} | Reverse Transfer Capacitance | | | 195 | | |
| $t_{d(ON)}$ | Turn-on Delay Time | | | 13 | | |
| t_r | Turn-on Rise Time | $V_{DD}=20V, R_L=0.5\Omega,$ $I_{DS}=45A, V_{GEN}=10V,$ $R_G=4.7\Omega$ | | 38 | | |
| $t_{d(OFF)}$ | Turn-off Delay Time | | | 54 | | |
| t_f | Turn-off Fall Time | | | 21 | | |
| Gate Charge Characteristics ⁽⁵⁾ | | | | | | |
| Q_g | Total Gate Charge | $V_{DS}=32V, V_{GS}=10V,$ $I_{DS}=45A$ | | 55 | | nC |
| Q_{gs} | Gate-Source Charge | | | 11 | | |
| Q_{gd} | Gate-Drain Charge | | | 18 | | |

- Notes: ① Calculated continuous current based on maximum allowable junction temperature. Package limitation current is 60A.
 ② Pulse width limited by safe operating area.
 ③ Limited by $T_{Jmax}, I_{AS}=39A, V_{DD}=32V, R_G=50\Omega$, Starting $T_J=25^\circ\text{C}$.
 ④ Pulse test; Pulse width $\leq 300\mu s$, duty cycle $\leq 2\%$.
 ⑤ Guaranteed by design, not subject to production testing.

Typical Characteristics

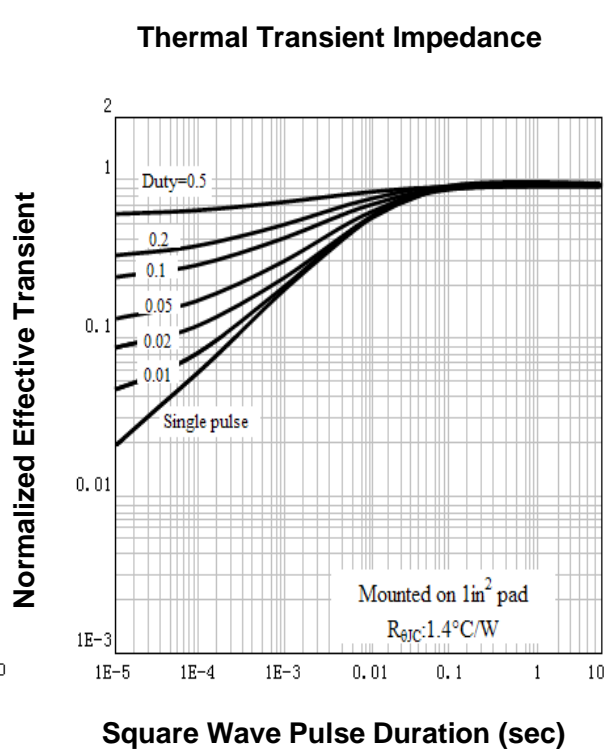
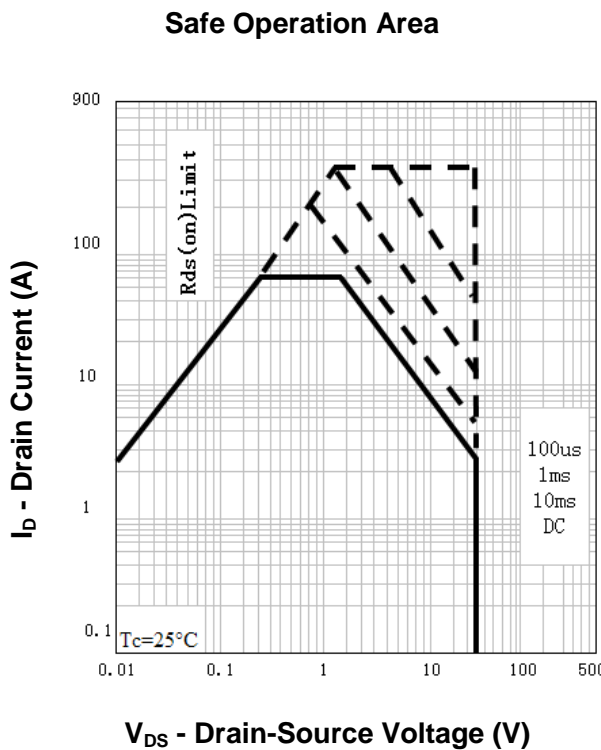
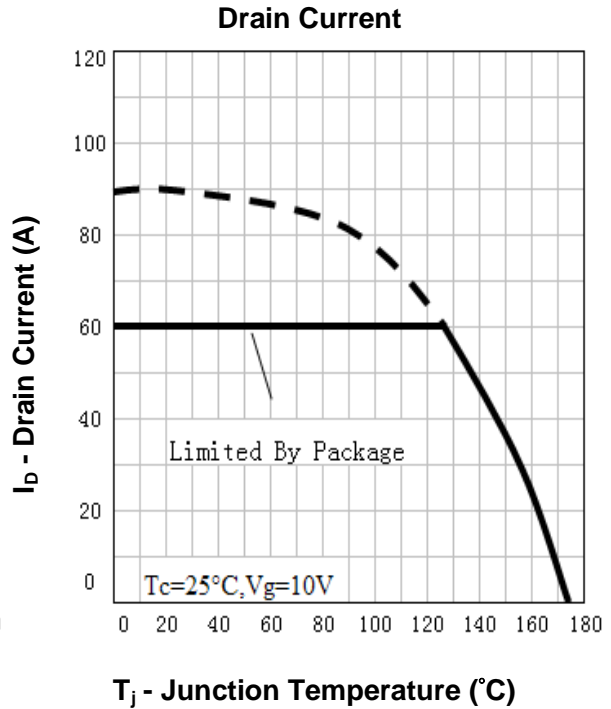
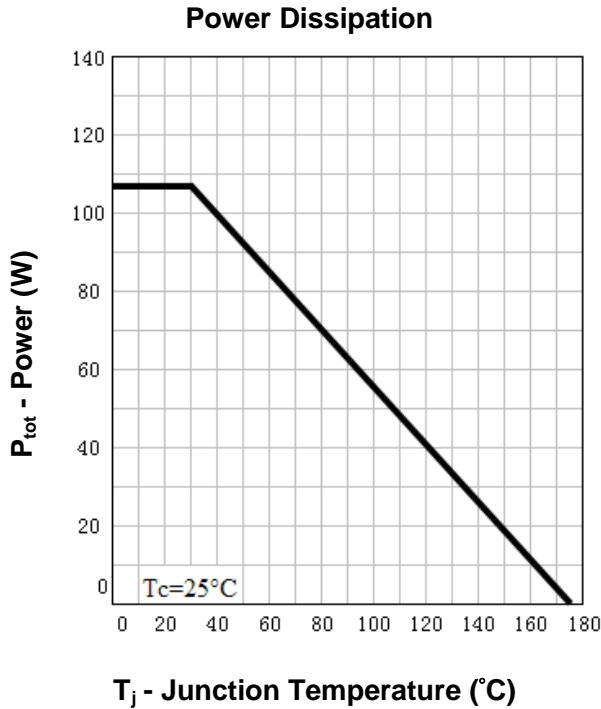

Typical Characteristics

Output Characteristics

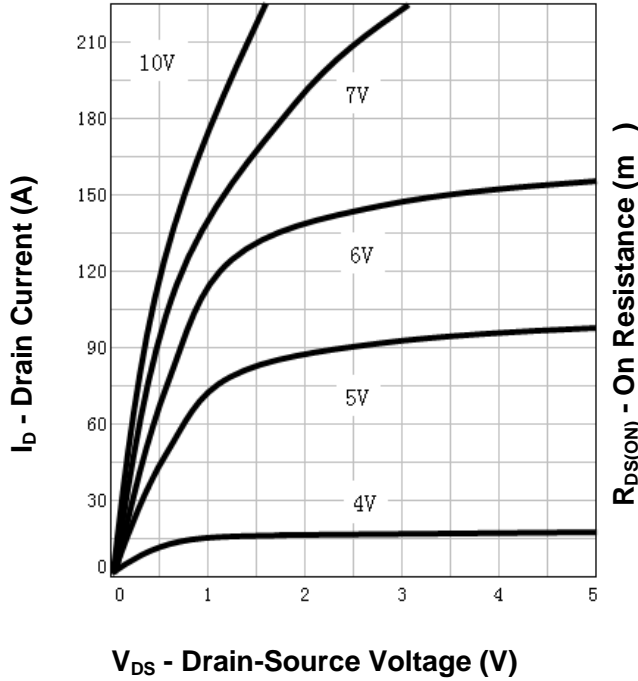

Drain-Source On Resistance

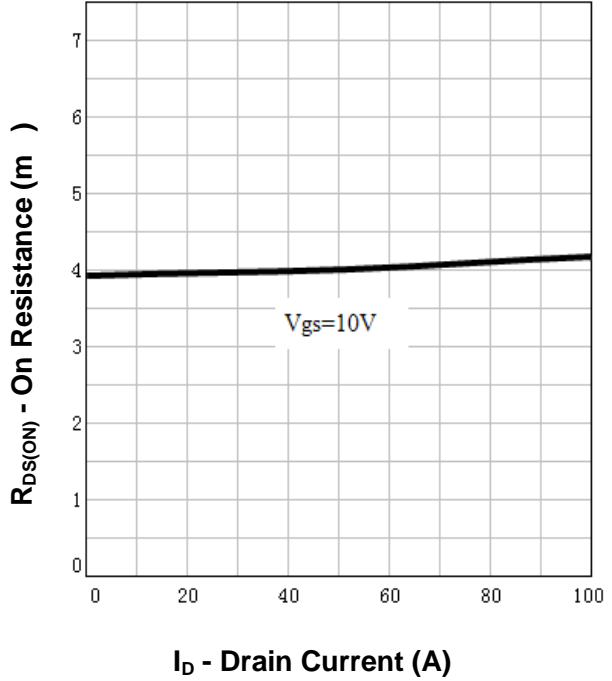

Drain-Source On Resistance

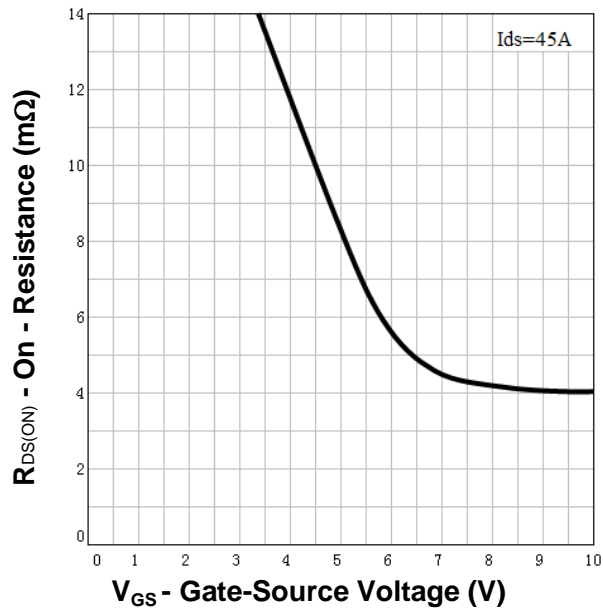

Gate Threshold Voltage

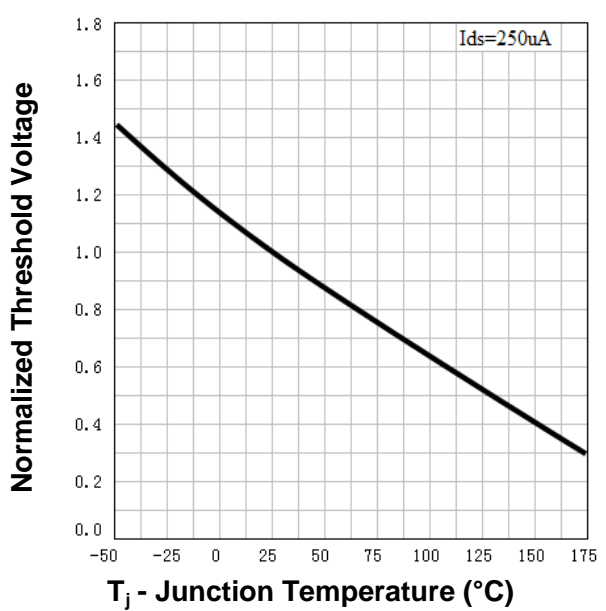

Typical Characteristics

Drain-Source On Resistance

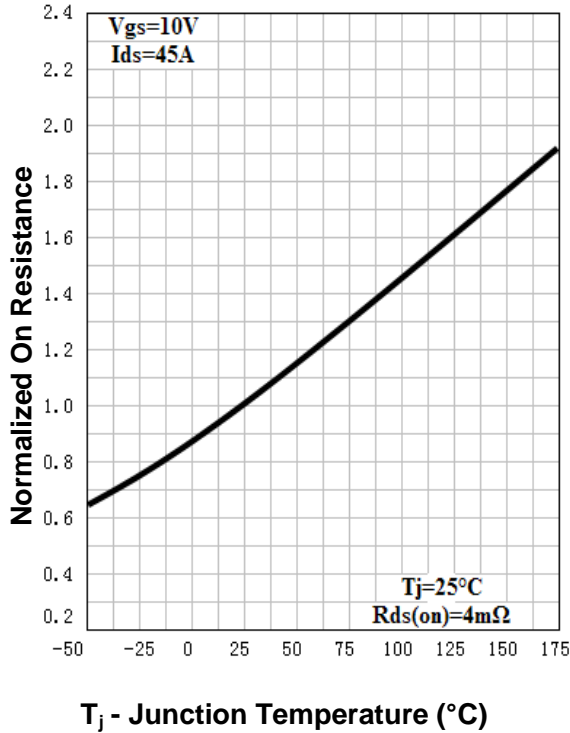

Source-Drain Diode Forward

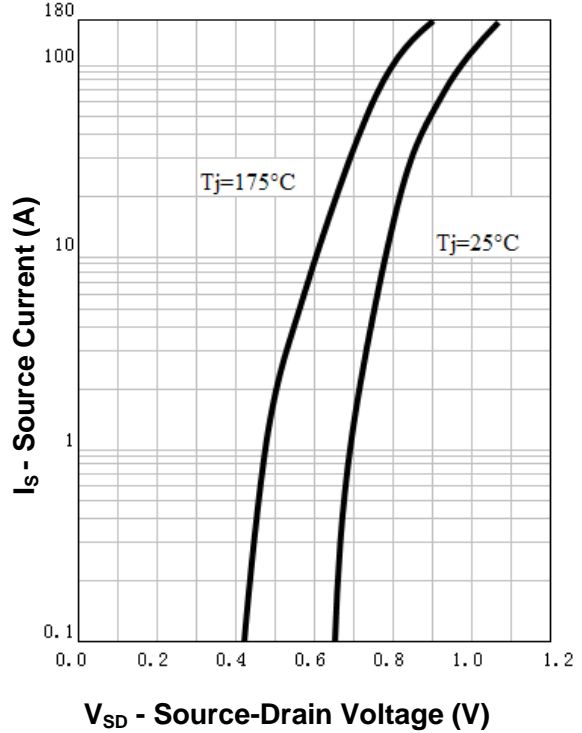

Capacitance

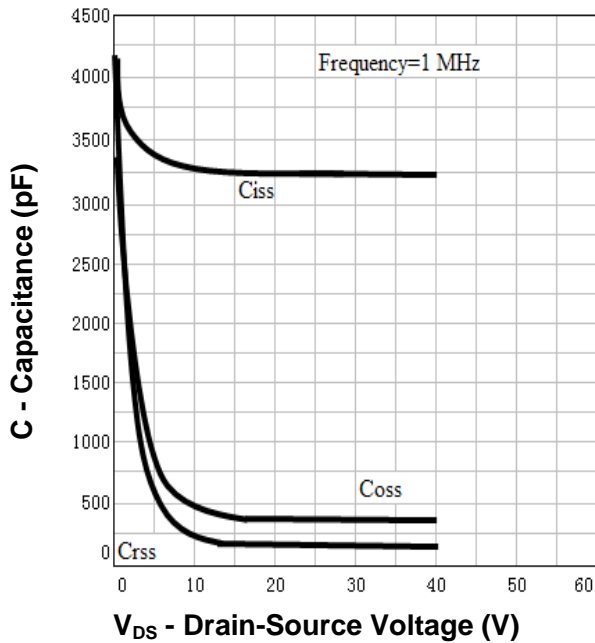

Gate Charge

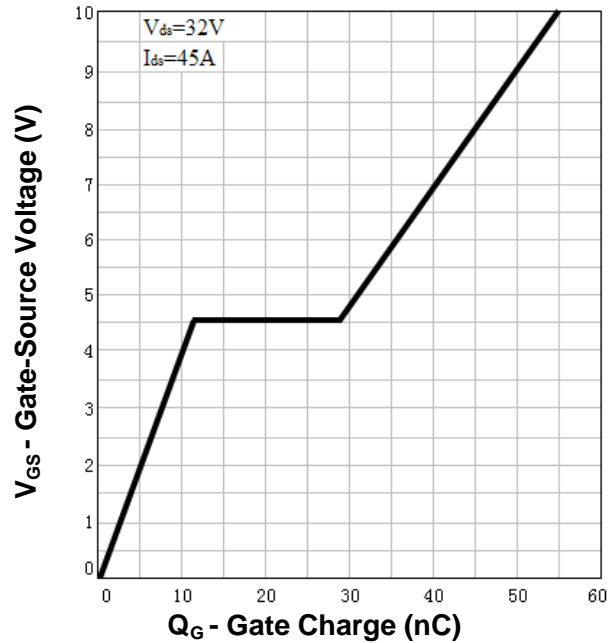

Avalanche Test Circuit and Waveforms

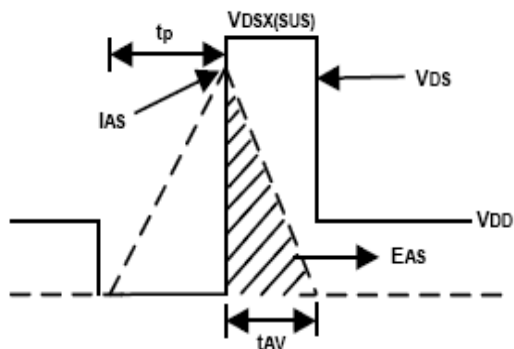
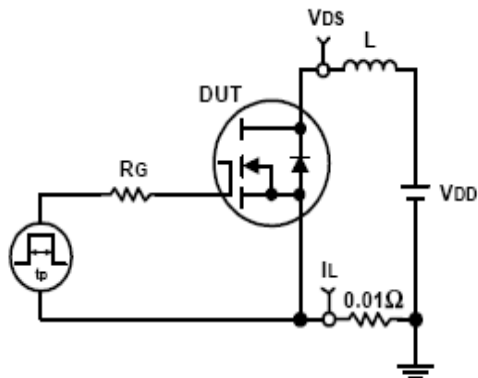

Switching Time Test Circuit and Waveforms

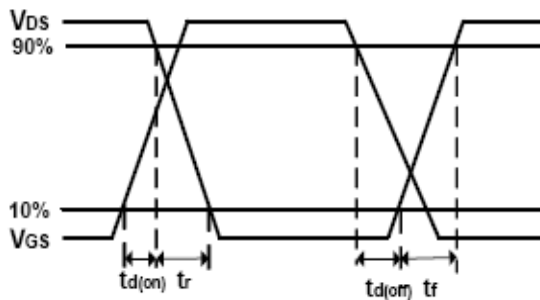
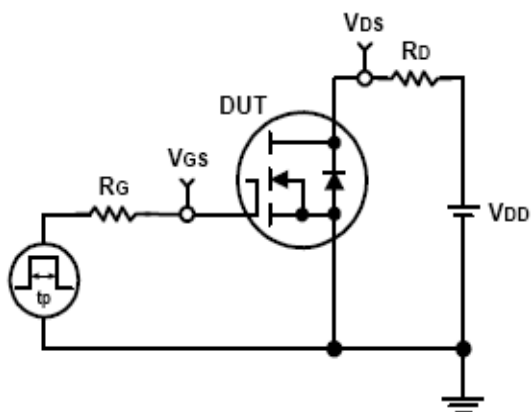

Ordering and Marking Information

| Device | Marking | Package | Packaging | Quantity | Reel Size | Tape width |
|---------------|----------------|----------------|------------------|-----------------|------------------|-------------------|
| RU4090L | RU4090L | TO-252 | Tape&Reel | 2500 | 13'' | 16mm |

Package Information

TO252-2L

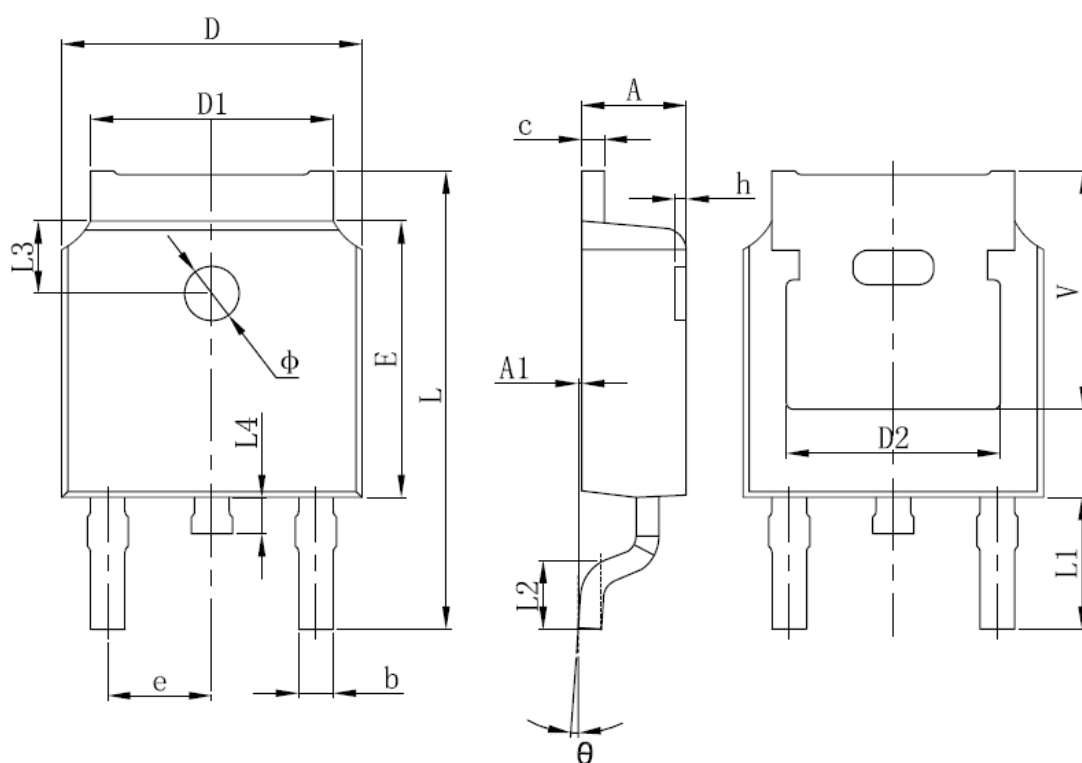

| SYMBOL | MM | | INCH | | SYMBOL | MM | | INCH | |
|--------|------------|-------|------------|-------|--------|------------|--------|------------|-------|
| | MIN | MAX | MIN | MAX | | MIN | MAX | MIN | MAX |
| A | 2.200 | 2.400 | 0.087 | 0.094 | L | 9.800 | 10.400 | 0.386 | 0.409 |
| A1 | 0.000 | 0.127 | 0.000 | 0.005 | L1 | 2.900 REF. | | 0.114 REF. | |
| b | 0.660 | 0.860 | 0.026 | 0.034 | L2 | 1.400 | 1.700 | 0.055 | 0.067 |
| C | 0.460 | 0.580 | 0.018 | 0.023 | L3 | 1.600 REF. | | 0.063 REF. | |
| D | 6.500 | 6.700 | 0.256 | 0.264 | L4 | 0.600 | 1.000 | 0.024 | 0.039 |
| D1 | 5.100 | 5.460 | 0.201 | 0.215 | Φ | 1.100 | 1.300 | 0.043 | 0.051 |
| D2 | 4.830 REF. | | 0.190 REF. | | θ | 0° | 8° | 0° | 8° |
| E | 6.000 | 6.200 | 0.236 | 0.244 | h | 0.000 | 0.300 | 0.000 | 0.012 |
| e | 2.186 | 2.386 | 0.086 | 0.094 | V | 5.350 REF. | | 0.211 REF. | |

ALL DIMENSIONS REFER TO JEDEC STANDARD
DO NOT INCLUDE MOLD FLASH OR PROTRUSIONS

Customer Service

Worldwide Sales and Service:

Sales@ruichips.com

Technical Support:

Technical@ruichips.com

Investor Relations Contacts:

Investor@ruichips.com

Marcom Contact:

Marcom@ruichips.com

Editorial Contact:

Editorial@ruichips.com

HR Contact:

HR@ruichips.com

Legal Contact:

Legal@ruichips.com

Shen Zhen RUICHIPS Semiconductor CO., LTD

Room 501, the 5floor An Tong Industrial Building,
NO.207 Mei Hua Road Fu Tian Area Shen Zhen City, CHINA

TEL: (86-755) 8311-5334

FAX: (86-755) 8311-4278

E-mail: Sales-SZ@ruichips.com