

Features

- -20V/-2.4A,
 $R_{DS(ON)} = 95m\Omega(Typ.)@V_{GS}=-4.5V$
 $R_{DS(ON)} = 140m\Omega(Typ.)@V_{GS}=-2.5V$
- Low On-Resistance
- Super High Dense Cell Design
- Reliable and Rugged
- Lead Free and Green Devices Available (RoHS Compliant)

Applications

- Load Switch

Pin Description

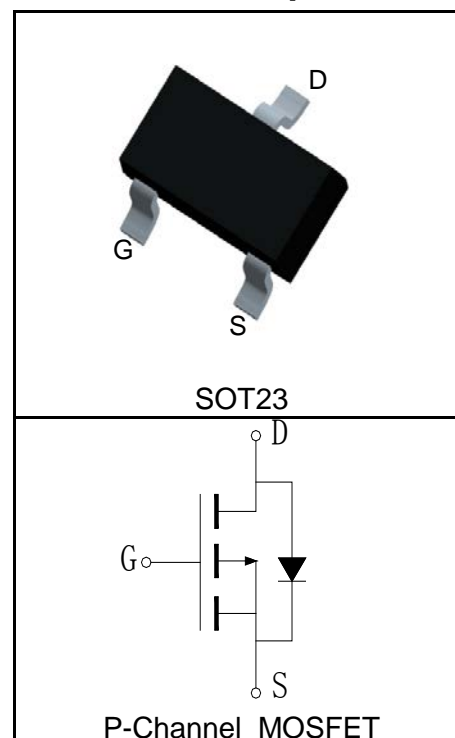

Absolute Maximum Ratings

Symbol	Parameter	Rating	Unit	
Common Ratings ($T_A=25^\circ C$ Unless Otherwise Noted)				
V_{DSS}	Drain-Source Voltage	-20	V	
V_{GSS}	Gate-Source Voltage	± 12		
T_J	Maximum Junction Temperature	150	$^\circ C$	
T_{STG}	Storage Temperature Range	-55 to 150	$^\circ C$	
I_S	Diode Continuous Forward Current	$T_A=25^\circ C$	-1.25	A
Mounted on Large Heat Sink				
$I_{DP}^{①}$	300 μs Pulse Drain Current Tested	$T_A=25^\circ C$	-9.6	A
$I_D^{②}$	Continuous Drain Current($V_{GS}=-4.5V$)	$T_A=25^\circ C$	-2.4	A
		$T_A=70^\circ C$	-1.9	
P_D	Maximum Power Dissipation	$T_A=25^\circ C$	1	W
		$T_A=70^\circ C$	0.64	
$R_{\theta JC}$	Thermal Resistance-Junction to Case	-	$^\circ C/W$	
$R_{\theta JA}^{③}$	Thermal Resistance-Junction to Ambient	125	$^\circ C/W$	
Drain-Source Avalanche Ratings				
$E_{AS}^{④}$	Avalanche Energy, Single Pulsed	TBD	mJ	

Electrical Characteristics ($T_A=25^{\circ}\text{C}$ Unless Otherwise Noted)

Symbol	Parameter	Test Condition	RU20P2B			Unit
			Min.	Typ.	Max.	
Static Characteristics						
BV_{DSS}	Drain-Source Breakdown Voltage	$V_{GS}=0V, I_{DS}=-250\mu A$	-20			V
I_{DSS}	Zero Gate Voltage Drain Current	$V_{DS}=-20V, V_{GS}=0V$			-1	μA
		$T_J=125^{\circ}\text{C}$			-30	
$V_{GS(th)}$	Gate Threshold Voltage	$V_{DS}=V_{GS}, I_{DS}=-250\mu A$	-0.4		-1	V
I_{GSS}	Gate Leakage Current	$V_{GS}=\pm 16V, V_{DS}=0V$			± 100	nA
$R_{DS(ON)}^{(5)}$	Drain-Source On-state Resistance	$V_{GS}=-4.5V, I_{DS}=-2.4A$		95	120	$m\Omega$
		$V_{GS}=-2.5V, I_{DS}=-1.8A$		140	160	$m\Omega$
Diode Characteristics						
$V_{SD}^{(5)}$	Diode Forward Voltage	$I_{SD}=-1A, V_{GS}=0V$			-1.2	V
t_{rr}	Reverse Recovery Time	$I_{SD}=-2.4A, di_{SD}/dt=100A/\mu s$		7		ns
Q_{rr}	Reverse Recovery Charge			4		nC
Dynamic Characteristics⁽⁶⁾						
R_G	Gate Resistance	$V_{GS}=0V, V_{DS}=0V, F=1\text{MHz}$		0.5		Ω
C_{iss}	Input Capacitance	$V_{GS}=0V, V_{DS}=-10V, \text{Frequency}=1.0\text{MHz}$		380		pF
C_{oss}	Output Capacitance			110		
C_{riss}	Reverse Transfer Capacitance			65		
$t_{d(ON)}$	Turn-on Delay Time			7		
t_r	Turn-on Rise Time	$V_{DD}=-10V, I_{DS}=-2.4A, V_{GEN}=-4.5V, R_G=6\Omega$		21		
$t_{d(OFF)}$	Turn-off Delay Time			33		
t_f	Turn-off Fall Time			12		
Gate Charge Characteristics⁽⁶⁾						
Q_g	Total Gate Charge	$V_{DS}=-16V, V_{GS}=-4.5V, I_{DS}=-2.4A$		5.3		nC
Q_{gs}	Gate-Source Charge			0.8		
Q_{gd}	Gate-Drain Charge			1.6		

- Notes:
- ① Pulse width limited by safe operating area.
 - ② Calculated continuous current based on maximum allowable junction temperature.
 - ③ When mounted on 1 inch square copper board, $t \leq 10\text{sec}$. The value in any given application depends on the user's specific board design.
 - ④ Limited by T_{jmax} . Starting $T_j = 25^{\circ}\text{C}$.
 - ⑤ Pulse test; Pulse width $\leq 300\mu s$, duty cycle $\leq 2\%$.
 - ⑥ Guaranteed by design, not subject to production testing.

Ordering and Marking Information

Device	Marking^①	Package	Packaging	Quantity	Reel Size	Tape width
RU20P2B	EXYWW	SOT23	Tape&Reel	3000	7"	8mm

① The following characters could be different and means:

X =Assembly site code

Y =Year

WW =Work Week

Typical Characteristics

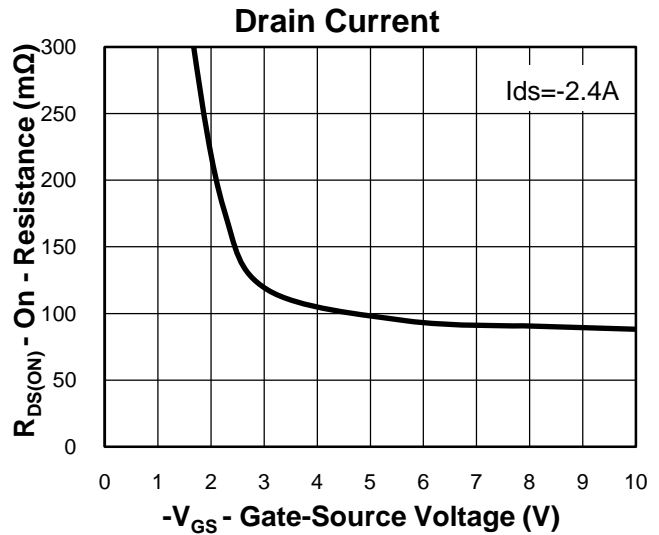
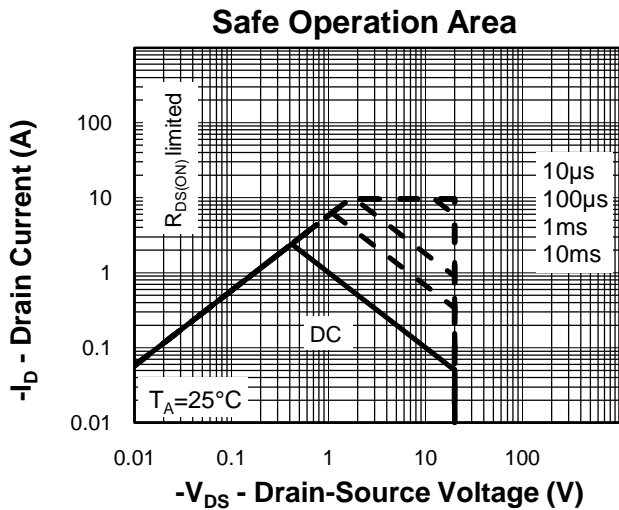
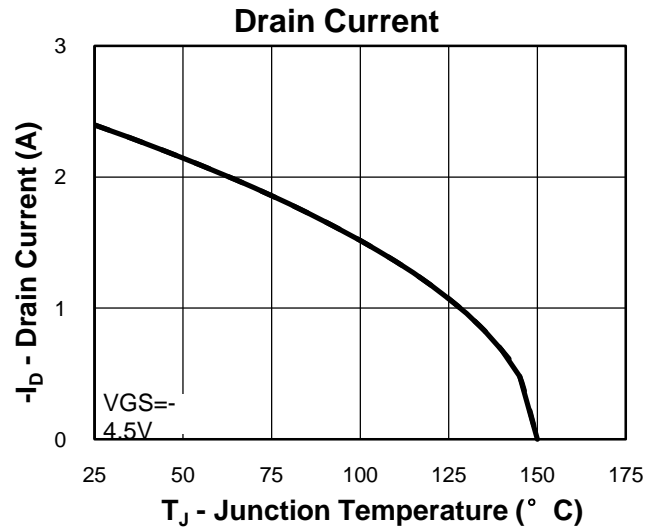
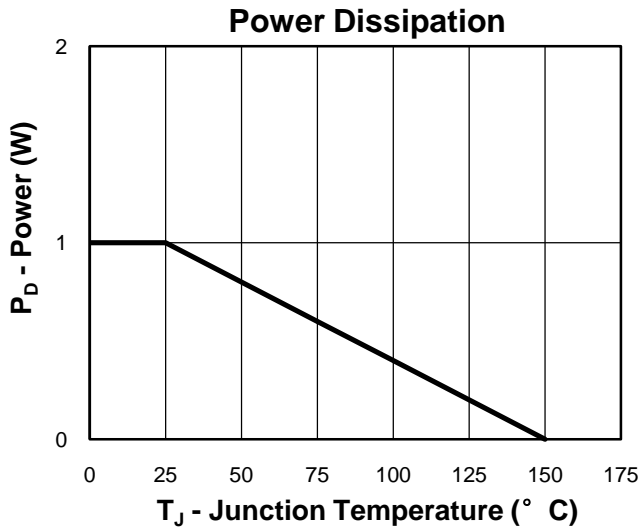

Thermal Transient Impedance

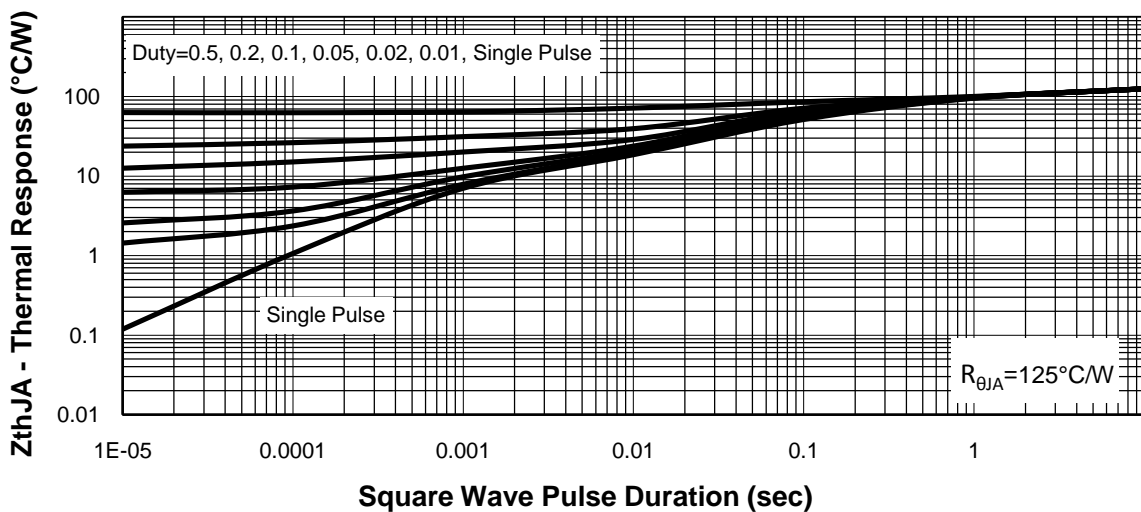

Typical Characteristics

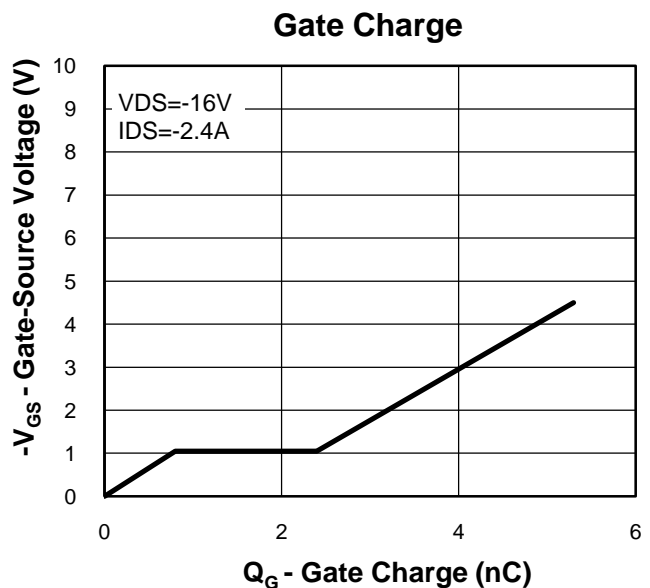
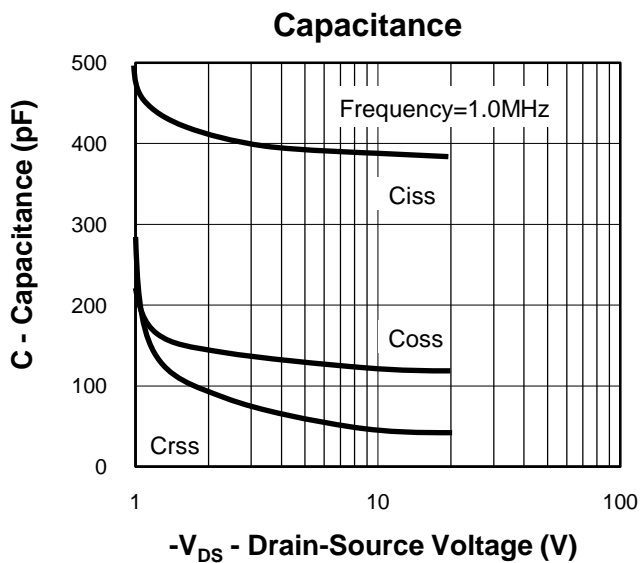
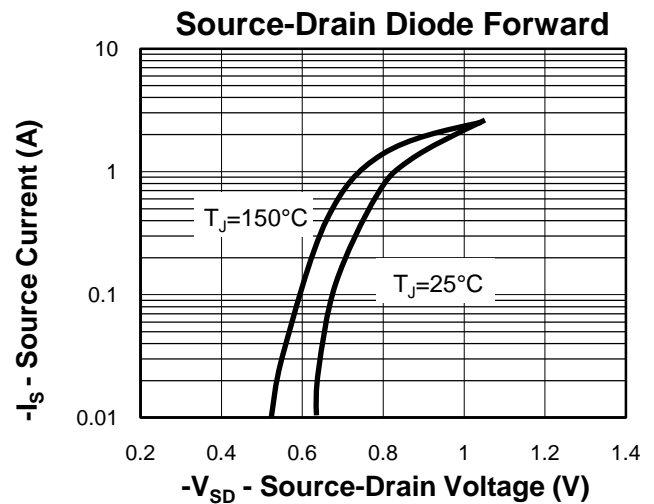
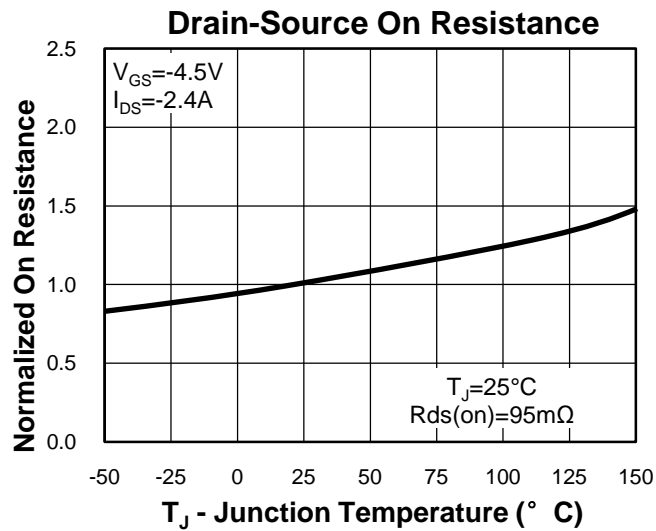
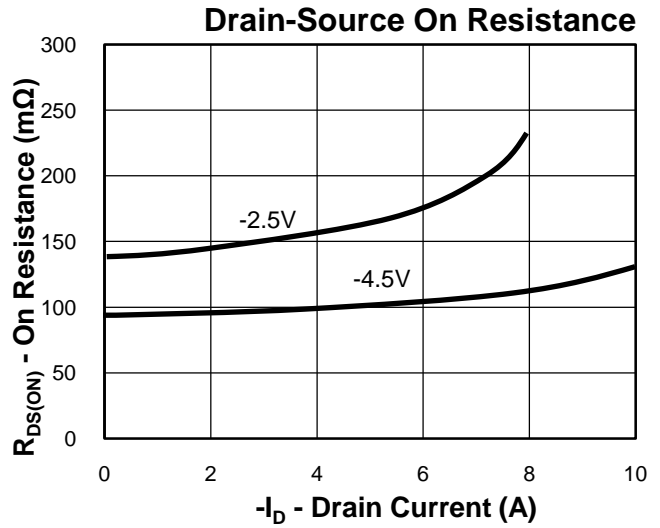
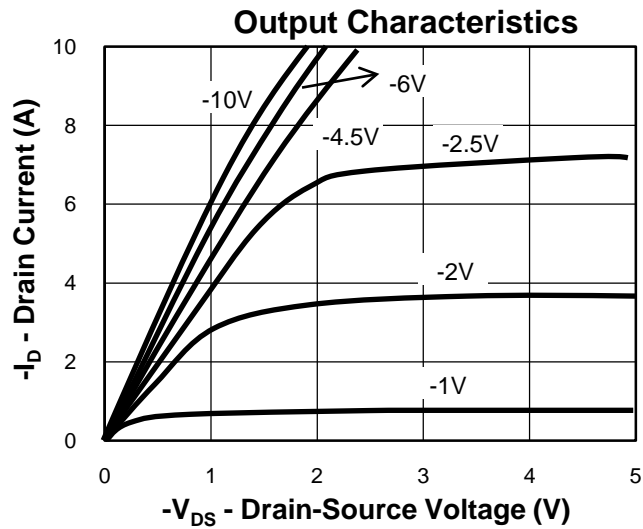

Avalanche Test Circuit and Waveforms

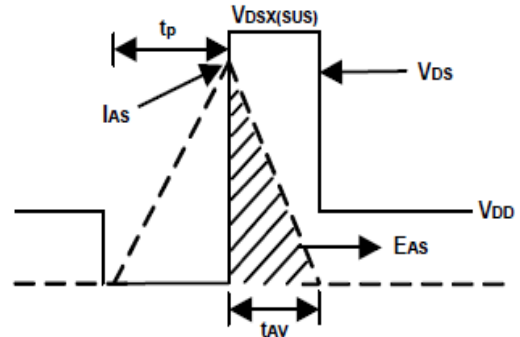
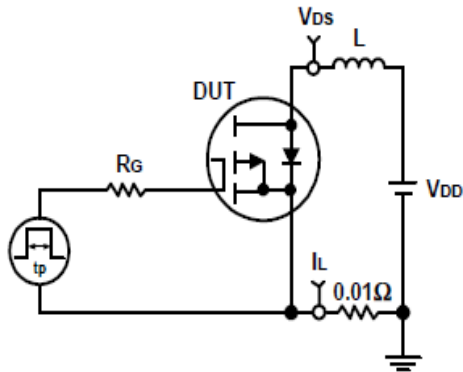

Switching Time Test Circuit and Waveforms

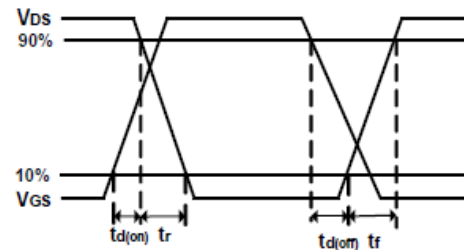
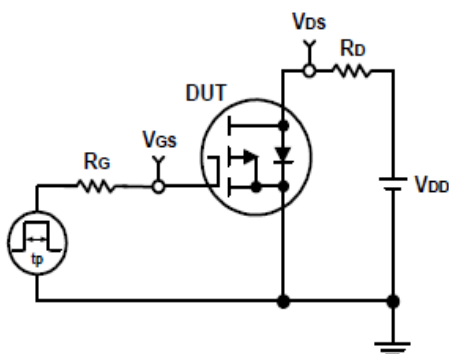

Package Information

SOT23

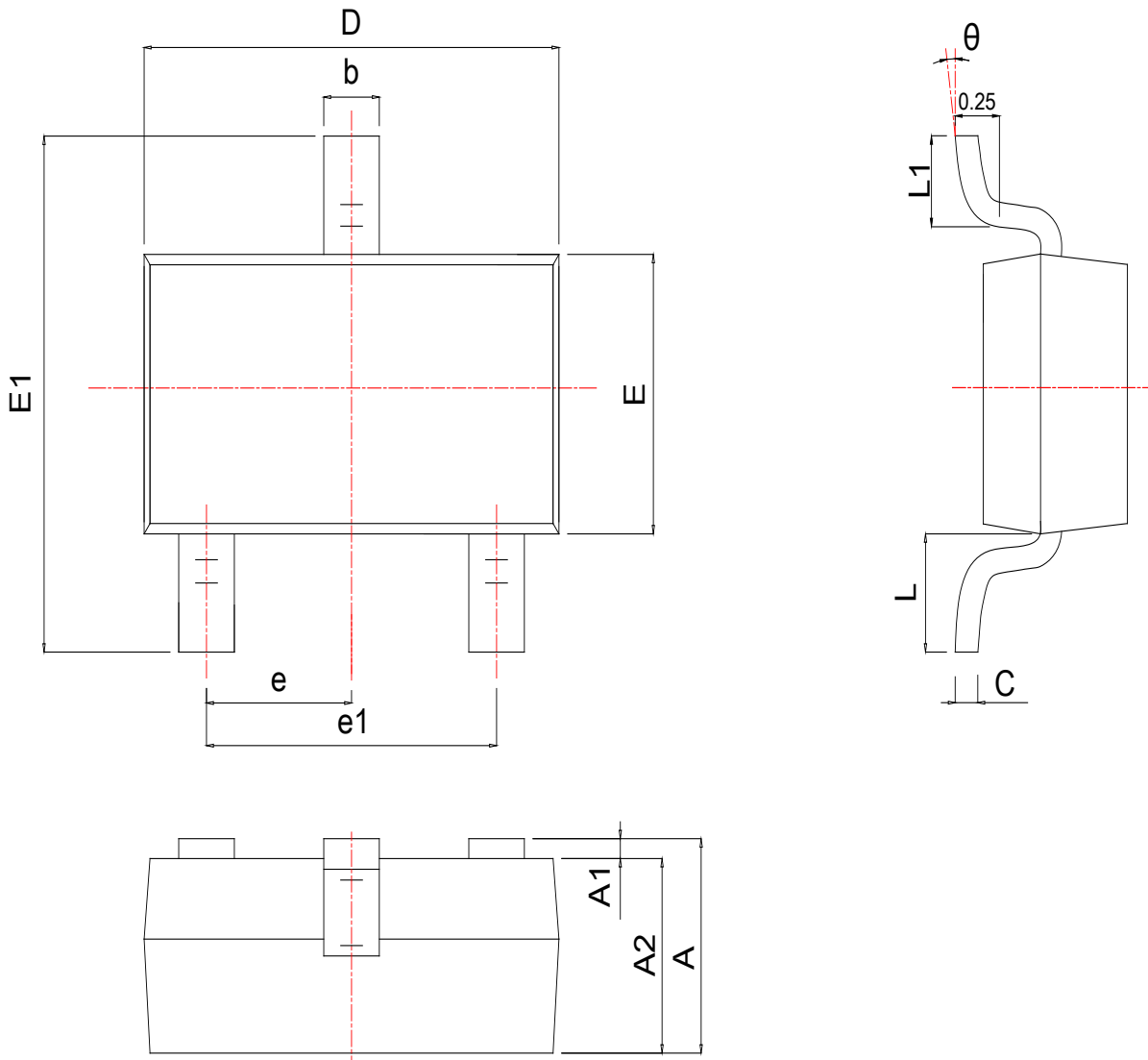

SYMBOL	MM			INCH		
	MIN	NOM	MAX	MIN	NOM	MAX
A	0.900	1.025	1.150	0.035	0.040	0.045
A1	0.050	0.075	0.100	0.002	0.003	0.004
A2	0.900	0.975	1.020	0.035	0.038	0.040
b	0.300	0.400	0.500	0.012	0.016	0.020
c	0.080	0.115	0.150	0.003	0.005	0.006
D	2.800	2.900	3.000	0.110	0.114	0.118
E	1.200	1.300	1.400	0.047	0.051	0.055
E1	2.250	2.400	2.550	0.089	0.094	0.100
e	0.950 TYP			0.037 TYP		
e1	1.800	1.900	2.000	0.071	0.075	0.079
L	0.540 REF			0.021 REF		
L1	0.400	0.500	0.600	0.016	0.018	0.020
θ	0°	*	8°	0°	*	8°

Customer Service

Worldwide Sales and Service:
Sales@ruichips.com

Technical Support:
Technical@ruichips.com

Investor Relations Contacts:
Investor@ruichips.com

Marcom Contact:
Marcom@ruichips.com

Editorial Contact:
Editorial@ruichips.com

HR Contact:
HR@ruichips.com

Legal Contact:
Legal@ruichips.com

Shen Zhen RUICHIPS Semiconductor CO., LTD
Room 501, the 5floor An Tong Industrial Building,
NO.207 Mei Hua Road Fu Tian Area Shen Zhen City, CHINA

TEL: (86-755) 8311-5334
FAX: (86-755) 8311-4278
E-mail: Sales-SZ@ruichips.com