

# KSH13005AF

**SemiHow**  
Know-How for Semiconductor

# KSH13005AF

## Switch Mode series NPN silicon Power Transistor

- High voltage, high speed power switching
- Suitable for switching regulator, inverters motor controls

### Absolute Maximum Ratings TC=25°C unless otherwise noted

4 Amperes  
NPN Silicon Power Transistor  
75 Watts

CHARACTERISTICS	SYMBOL	RATING	UNIT
Collector-Base Voltage	$V_{CBO}$	700	V
Collector-Emitter Voltage	$V_{CEO}$	400	V
Emitter-Base Voltage	$V_{EBO}$	9	V
Collector Current(DC)	$I_C$	4	A
Collector Current(Pulse)	$I_{CP}$	8	A
Base Current	$I_B$	2	A
Collector Dissipation(Tc=25°C)	$P_C$	30	W
Junction Temperature	$T_J$	150	°C
Storage Temperature	$T_{STG}$	-65~150	°C

TO-220F  
1. Base  
2. Collector  
3. Emitter

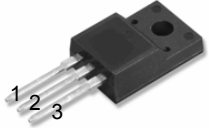

### Electrical Characteristics TC=25°C unless otherwise noted

CHARACTERISTICS	SYMBOL	Test Condition	Min	Typ.	Max	Unit
Collector-Emitter Breakdown Voltage	$V_{CEO}$	$I_C=10mA, I_B=0$	400			V
Emitter Cut-off Current	$I_{EBO}$	$V_{EB}=9V, I_C=0$			1	mA
*DC Current Gain	$h_{FE1}$ $h_{FE2}$	$V_{CE}=5V, I_C=1A$ $V_{CE}=5V, I_C=2A$	10 8		60 40	
*Collector-Emitter Saturation Voltage	$V_{CE(sat)}$	$I_C=1A, I_B=0.2A$ $I_C=2A, I_B=0.5A$ $I_C=4A, I_B=1A$			0.5 0.6 1	V V V
*Base-Emitter Saturation Voltage	$V_{BE(sat)}$	$I_C=1A, I_B=0.2A$ $I_C=2A, I_B=0.5A$			1.2 1.6	V V
Output Capacitance	$C_{ob}$	$V_{CB}=10V, f=0.1MHz$		65		pF
Current Gain Bandwidth Product	$f_T$	$V_{CE}=10V, I_C=0.5A$	4			MHz
Turn on Time	$t_{on}$	$V_{CC}=125V, I_C=2A$ $I_{B1}=0.4A, I_{B2}=-0.4A$ $R_L=62.5\Omega$			0.8	μs
Storage Time	$t_{stg}$				4.0	μs
Fall Time	$t_F$				0.9	μs

\* Pulse Test: Pulse Width≤300μs, Duty Cycle≤2%

Note.

Package Mark information.

<b>hFE1 Classification</b>	R	19 ~ 28	<b>S</b> <b>YWW Z</b> <b>KSH13005AF</b>	S	SemiHow Symbol
	O	26 ~ 35		YWW	Y; year code, WW; week code
	Y	33 ~ 40		Z	hFE1 Classification

## Typical Characteristics

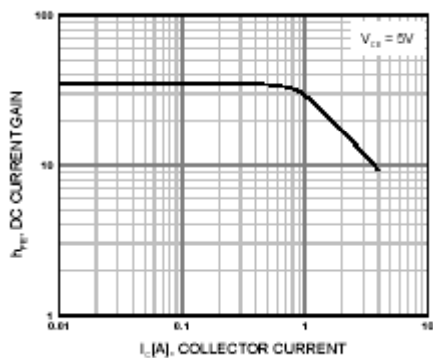

Figure 1. DC current Gain

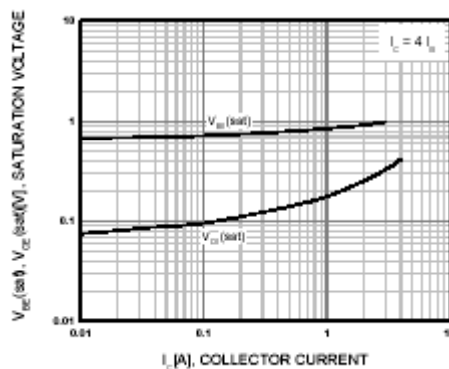

Figure 2. Base-Emitter Saturation Voltage  
Collector-Emitter Saturation Voltage

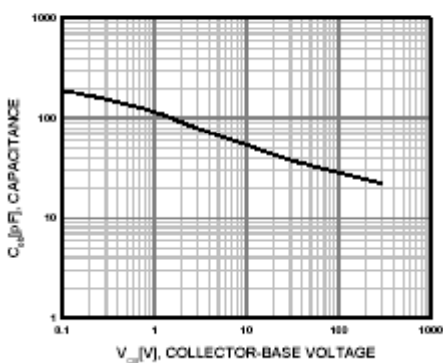

Figure 3. Collector Output Capacitance

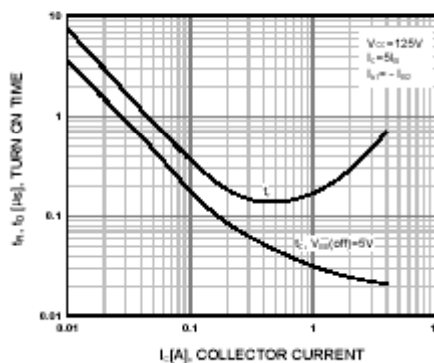

Figure 4. Turn On Time

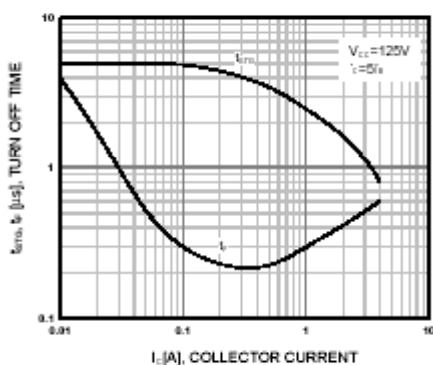

Figure 5. Turn Off Time

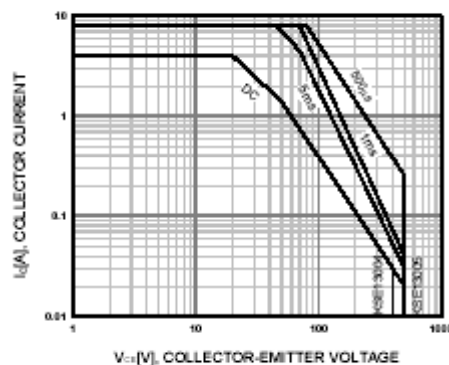
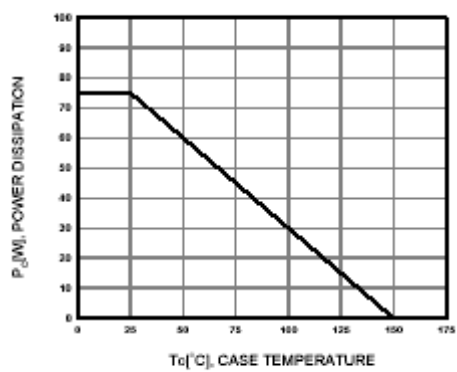
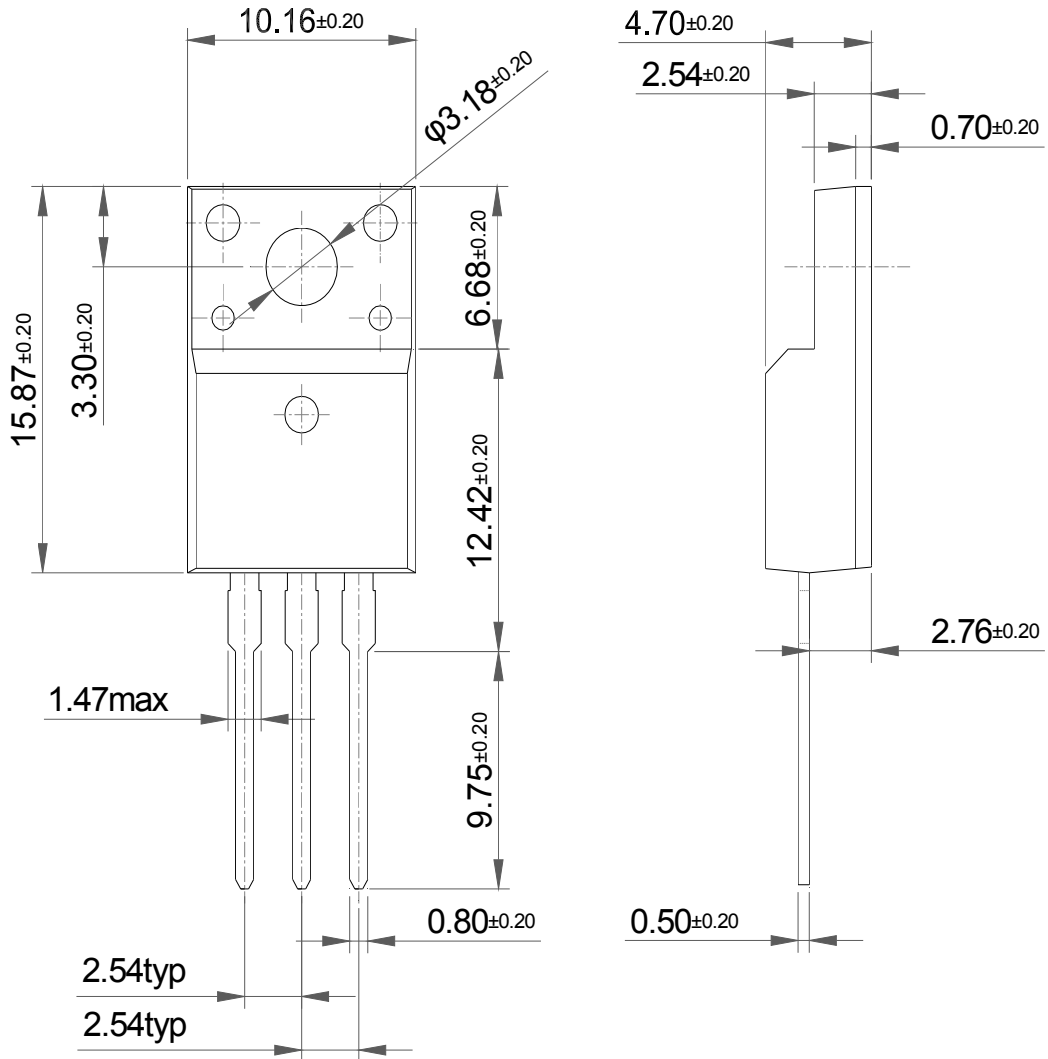

Figure 6. Safe Operating Area

**Typical Characteristics** ( Continued )**Figure 7. Power Derating**

Package Dimension

TO-220F



Dimensions in Millimeters