

# KSH13004

**SemiHow**  
Know-How for Semiconductor

# KSH13004

## Switch Mode series NPN silicon Power Transistor

- High voltage, high speed power switching
- Suitable for switching regulator, inverters motor controls

4 Amperes  
 NPN Silicon Power Transistor  
 75 Watts

### Absolute Maximum Ratings $T_C=25^{\circ}\text{C}$ unless otherwise noted

CHARACTERISTICS	SYMBOL	RATING	UNIT
Collector-Base Voltage	$V_{CBO}$	600	V
Collector-Emitter Voltage	$V_{CEO}$	300	V
Emitter-Base Voltage	$V_{EBO}$	9	V
Collector Current(DC)	$I_C$	4	A
Collector Current(Pulse)	$I_{CP}$	8	A
Base Current	$I_B$	2	A
Collector Dissipation( $T_C=25^{\circ}\text{C}$ )	$P_C$	75	W
Junction Temperature	$T_J$	150	$^{\circ}\text{C}$
Storage Temperature	$T_{STG}$	-65~150	$^{\circ}\text{C}$

TO-220  
 1. Base  
 2. Collector  
 3. Emitter



### Electrical Characteristics $T_C=25^{\circ}\text{C}$ unless otherwise noted

CHARACTERISTICS	SYMBOL	Test Condition	Min	Typ.	Max	Unit
Collector-Emitter Breakdown Voltage	$V_{CEO}$	$I_C=10\text{mA}, I_B=0$	300			V
Emitter Cut-off Current	$I_{EBO}$	$V_{EB}=9\text{V}, I_C=0$			1	mA
*DC Current Gain	$h_{FE1}$ $h_{FE2}$	$V_{CE}=5\text{V}, I_C=1\text{A}$ $V_{CE}=5\text{V}, I_C=2\text{A}$	10 8		60 40	
*Collector-Emitter Saturation Voltage	$V_{CE(sat)}$	$I_C=1\text{A}, I_B=0.2\text{A}$ $I_C=2\text{A}, I_B=0.5\text{A}$ $I_C=4\text{A}, I_B=1\text{A}$			0.5 0.6 1	V V V
*Base-Emitter Saturation Voltage	$V_{BE(sat)}$	$I_C=1\text{A}, I_B=0.2\text{A}$ $I_C=2\text{A}, I_B=0.5\text{A}$			1.2 1.6	V V
Output Capacitance	$C_{ob}$	$V_{CB}=10\text{V}, f=0.1\text{MHz}$		65		pF
Current Gain Bandwidth Product	$f_T$	$V_{CE}=10\text{V}, I_C=0.5\text{A}$	4			MHz
Turn on Time	$t_{on}$	$V_{CC}=125\text{V}, I_C=2\text{A}$ $I_{B1}=0.4\text{A}, I_{B2}=-0.4\text{A}$ $R_L=62.5\Omega$			0.8	$\mu\text{s}$
Storage Time	$t_{stg}$				4.0	$\mu\text{s}$
Fall Time	$t_F$				0.9	$\mu\text{s}$

\* Pulse Test: Pulse Widths $\leq 300\mu\text{s}$ , Duty Cycles $\leq 2\%$

#### Note.

hFE1 Classification	R	19 ~ 28
	O	26 ~ 35
	Y	33 ~ 40

#### Package Mark information.

S YWW Z KSH13004	S	SemiHow Symbol
	YWW	Y; year code, WW; week code
	Z	hFE1 Classification

# Typical Characteristics

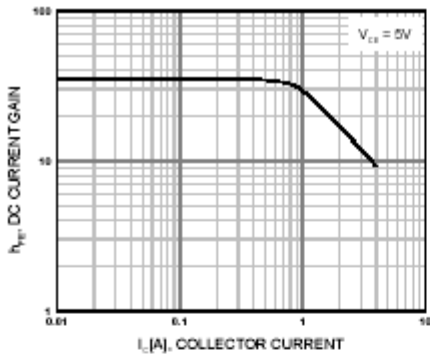

Figure 1. DC current Gain

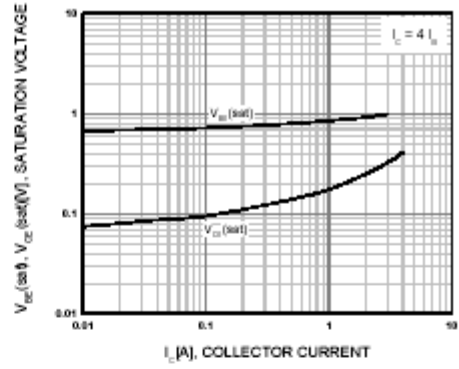

Figure 2. Base-Emitter Saturation Voltage  
Collector-Emmitter Saturation Voltage

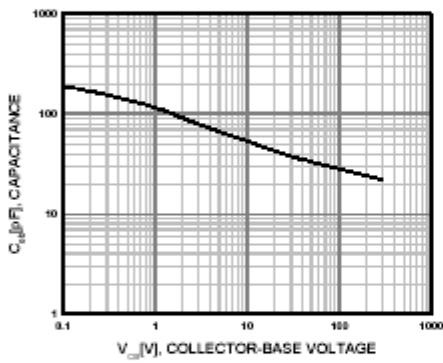

Figure 3. Collector Output Capacitance

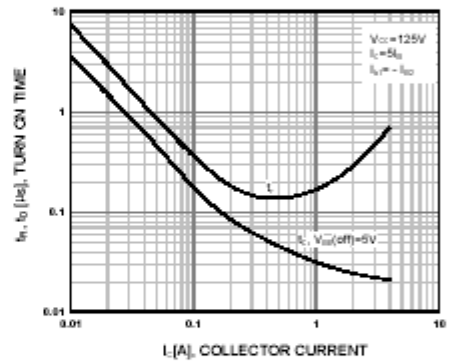

Figure 4. Turn On Time

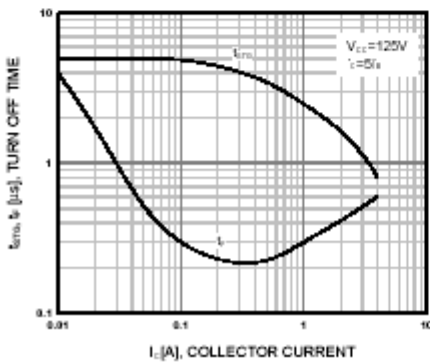

Figure 5. Turn Off Time

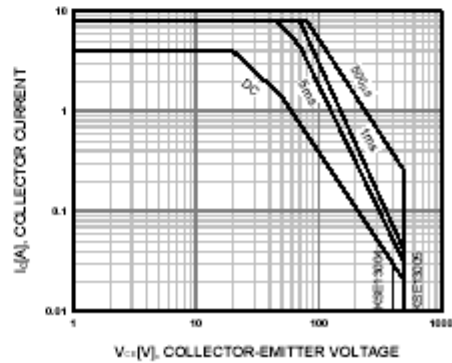

Figure 6. Safe Operating Area

### Typical Characteristics ( Continued )

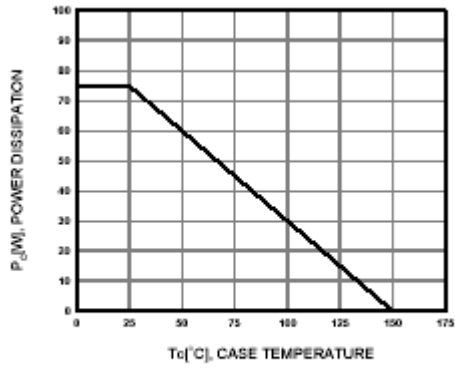
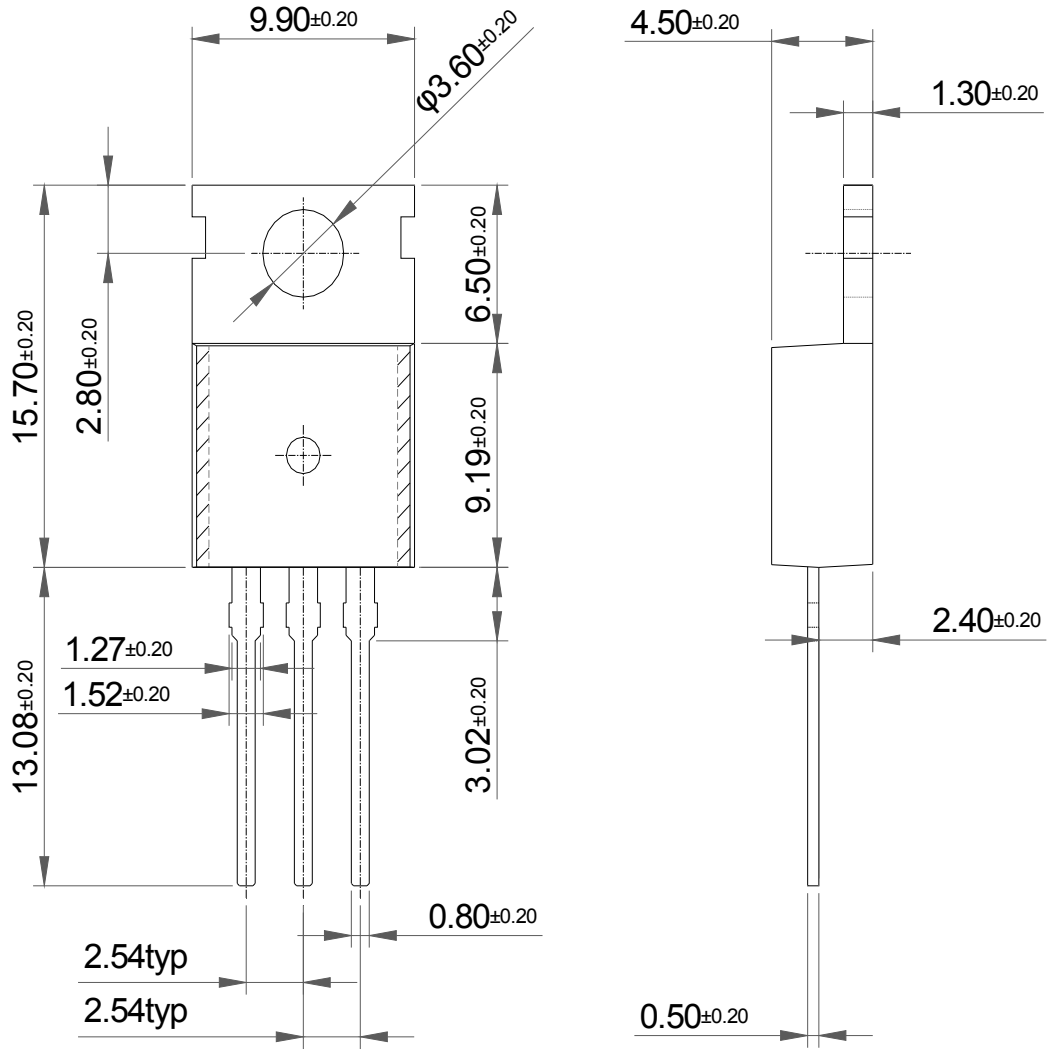

Figure 7. Power Derating

Package Dimension

TO-220 (A)



Package Dimension

TO-220 (B)

