

HIH30N120TF

1200V Field Stop Trench IGBT

$$V_{CES} = 1200 \text{ V}$$

$$I_C = 30 \text{ A}$$

$$V_{CE(sat) \text{ typ}} = 2.0 \text{ V}$$

FEATURES

- 1200V Field Stop Trench Technology
- High Speed Switching
- Low Conduction Loss
- Positive Temperature Coefficient
- Easy Parallel Operation

TO-3P

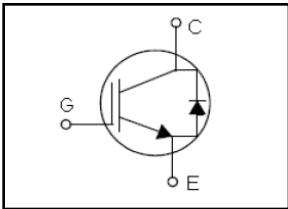

Absolute Maximum Ratings

Symbol	Parameter	Value	Units
V_{CES}	Collector-Emitter Voltage	1200	V
I_C	Collector Current – Continuous ($T_C = 25^\circ\text{C}$)	60	A
	Collector Current – Continuous ($T_C = 100^\circ\text{C}$)	30	A
I_{CM}	Collector Current – Pulsed (Note 1)	90	A
I_F	Diode Forward Current – Continuous ($T_C = 25^\circ\text{C}$)	60	A
	Diode Forward Current – Continuous ($T_C = 100^\circ\text{C}$)	30	A
I_{FM}	Diode Current – Pulsed (Note 1)	90	A
V_{GES}	Gate-Emitter Voltage	± 20	V
P_D	Power Dissipation – Continuous ($T_C = 25^\circ\text{C}$)	329	W
	Power Dissipation – Continuous ($T_C = 100^\circ\text{C}$)	132	
T_J	Operating Temperature Range	-55 to +150	$^\circ\text{C}$
T_{STG}	Storage Temperature Range	-55 to +150	$^\circ\text{C}$
T_L	Maximum lead temperature for soldering purposes, 1/8" from case for 5 seconds	300	$^\circ\text{C}$

Notes.

1. Pulse width limited by max junction temperature

Thermal Resistance Characteristics

Symbol	Parameter	Typ.	Max.	Units
$R_{\theta JC}(IGBT)$	Junction-to-Case	--	0.38	$^\circ\text{C/W}$
$R_{\theta JC}(\text{Diode})$	Junction-to-Case	--	2.1	
$R_{\theta JA}$	Junction-to-Ambient	--	40	

Package Marking and Odering Information

Device Marking	Week Marking	Package	Packing	Quantity	RoHS Status
HIH30N120TF	YWWX	TO-3P	Tube	30	Pb Free
HIH30N120TF	YWWXg	TO-3P	Tube	30	Halogen Free

Electrical Characteristics of the IGBT $T_C=25^\circ\text{C}$ unless otherwise specified

Symbol	Parameter	Test Conditions	Min	Typ	Max	Units
--------	-----------	-----------------	-----	-----	-----	-------

On Characteristics

$V_{GE(th)}$	Gate-Emitter Threshold Voltage	$V_{CE} = V_{GE}, I_C = 30\text{ mA}$	3.5	5.5	7.5	V
$V_{CE(sat)}$	Collector-Emitter Saturation Voltage	$V_{GE} = 15\text{ V},$ $I_C = 30\text{ A}$	--	2.0	2.5	V
		$T_C = 125^\circ\text{C}$	--	2.3	--	

Off Characteristics

BV_{CES}	Collector-Emitter Breakdown Voltage	$V_{GE} = 0\text{ V}, I_C = 1\text{ mA}$	1200	--	--	V
I_{CES}	Zero Gate Voltage Collector Current	$V_{CE} = 1200\text{ V}, V_{GE} = 0\text{ V}$	--	--	1	mA
I_{GES}	Gate-Emitter Leakage Current	$V_{GE} = \pm 20\text{ V}, V_{CE} = 0\text{ V}$	--	--	± 250	nA

Dynamic Characteristics

C_{iss}	Input Capacitance	$V_{CE} = 30\text{ V}, V_{GE} = 0\text{ V},$ $f = 1.0\text{ MHz}$	--	4000	--	pF
C_{oss}	Output Capacitance		--	105	--	pF
C_{rss}	Reverse Transfer Capacitance		--	72	--	pF

Switching Characteristics

$t_{d(on)}$	Turn-On Time	$V_{CC} = 600\text{ V}, I_C = 30\text{ A},$ $R_G = 10\ \Omega, V_{GE} = 15\text{ V}$ Inductive load, $T_C = 25^\circ\text{C}$	--	40	--	ns
t_r	Turn-On Rise Time		--	50	--	ns
$t_{d(off)}$	Turn-Off Delay Time		--	245	--	ns
t_f	Turn-Off Fall Time		--	70	150	ns
E_{on}	Turn-On Switching Loss		--	4.5	6.75	mJ
E_{off}	Turn-Off Switching Loss		--	0.85	1.28	mJ
E_{ts}	Total Switching Loss		--	5.35	8.03	mJ
$t_{d(on)}$	Turn-On Time	$V_{CC} = 600\text{ V}, I_C = 30\text{ A},$ $R_G = 10\ \Omega, V_{GE} = 15\text{ V}$ Inductive load, $T_C = 125^\circ\text{C}$	--	46	--	ns
t_r	Turn-On Rise Time		--	48	--	ns
$t_{d(off)}$	Turn-Off Delay Time		--	256	--	ns
t_f	Turn-Off Fall Time		--	142	--	ns
E_{on}	Turn-On Switching Loss		--	4.87	7.3	mJ
E_{off}	Turn-Off Switching Loss		--	1.82	2.73	mJ
E_{ts}	Total Switching Loss		--	6.67	10.03	mJ
Q_g	Total Gate Charge	$V_{CC} = 600\text{ V}, I_C = 30\text{ A},$ $V_{GE} = 15\text{ V}$	--	220	330	nC
Q_{ge}	Gate-Emitter Charge		--	30	45	nC
Q_{gc}	Gate-Collector Charge		--	90	135	nC

Electrical Characteristics of the Diode

V_{FM}	Diode Forward Voltage	$I_F = 30\text{ A}$	$T_C = 25^\circ\text{C}$	--	2.25	2.75	V
			$T_C = 125^\circ\text{C}$	--	2.53	--	
t_{rr}	Diode Reverse Recovery Time		$T_C = 25^\circ\text{C}$	--	300	450	ns
			$T_C = 125^\circ\text{C}$	--	360	--	
I_{rr}	Diode Peak Reverse Recovery Current	$I_F = 30\text{ A},$ $di/dt = 200\text{ A}/\mu\text{s}$	$T_C = 25^\circ\text{C}$	--	30	45	A
			$T_C = 125^\circ\text{C}$	--	34	--	
Q_{rr}	Diode Reverse Recovery Charge		$T_C = 25^\circ\text{C}$	--	4400	--	nC
			$T_C = 125^\circ\text{C}$	--	6120	--	

IGBT Characteristics

Fig. 1 Output characteristics

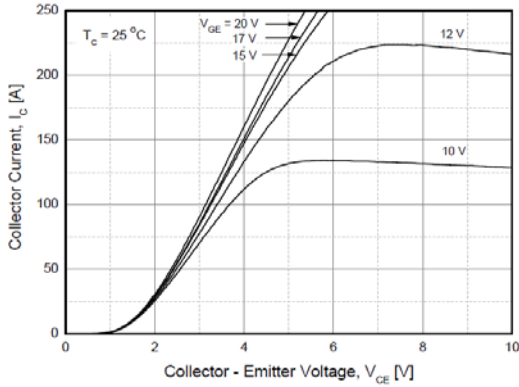

Fig. 2 Saturation voltage characteristics

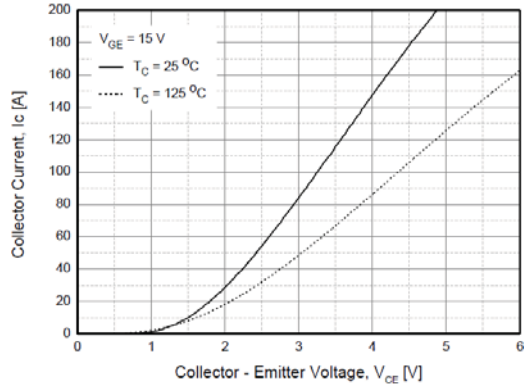

Fig. 3 Saturation voltage vs. collector current

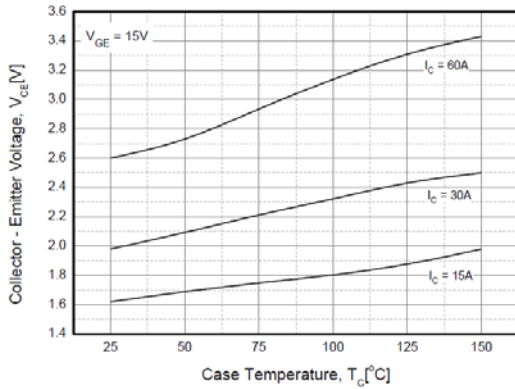

Fig. 4 Saturation voltage vs. gate bias

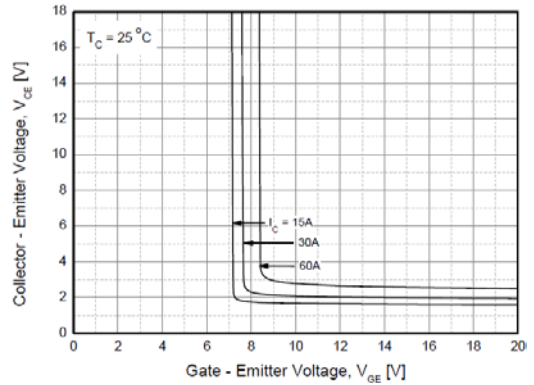

Fig. 5 Saturation voltage vs. gate bias

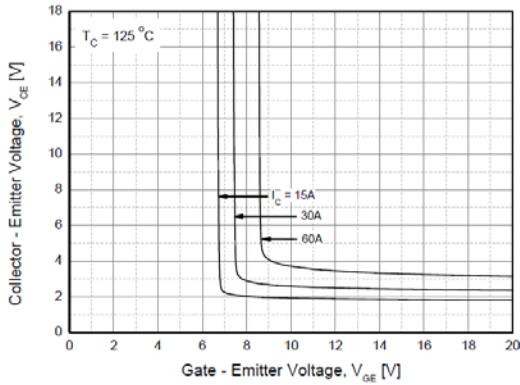
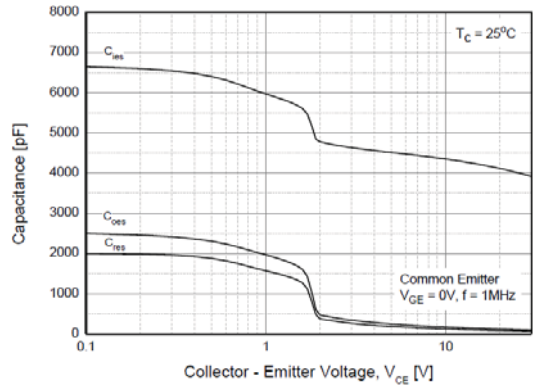

Fig. 6 Capacitance characteristics



IGBT Characteristics

Fig. 7 Turn-on time vs. gate resistor

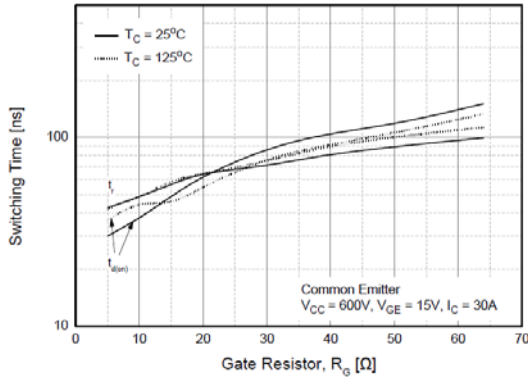

Fig. 8 Turn-off time vs. gate resistor

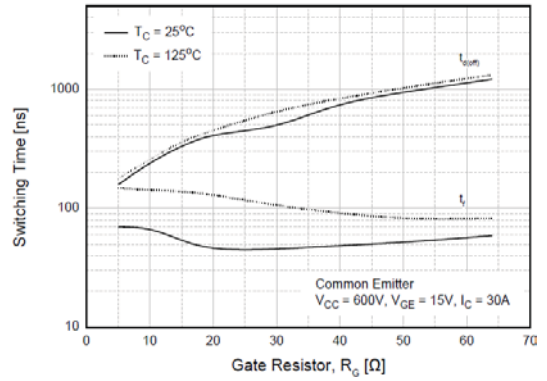

Fig. 9 Switching loss vs. gate resistor

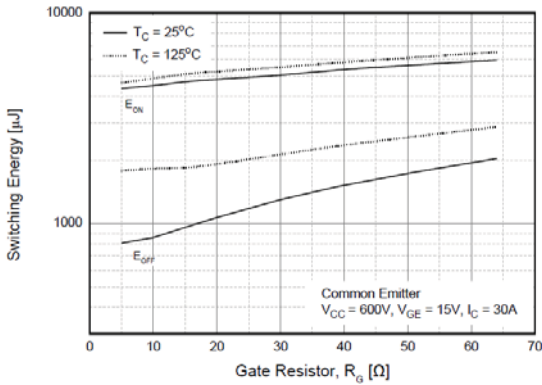

Fig. 10 Turn-on time vs. collector current

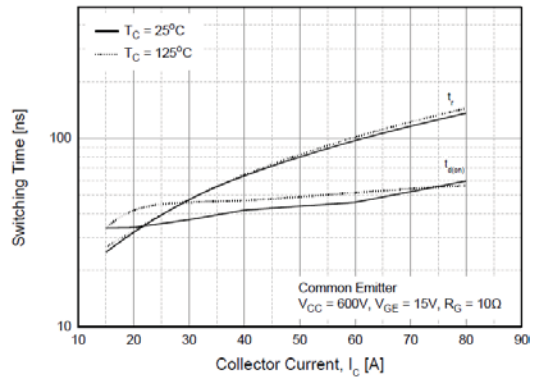

Fig. 11 Turn-off time vs. collector current

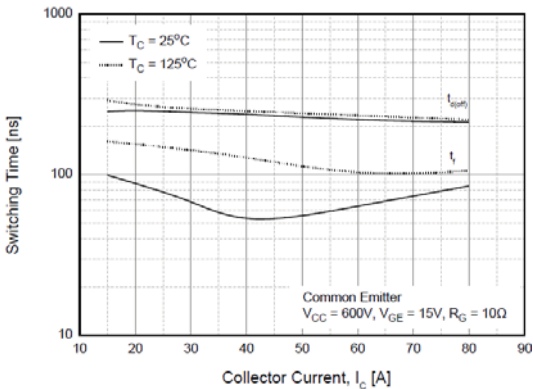
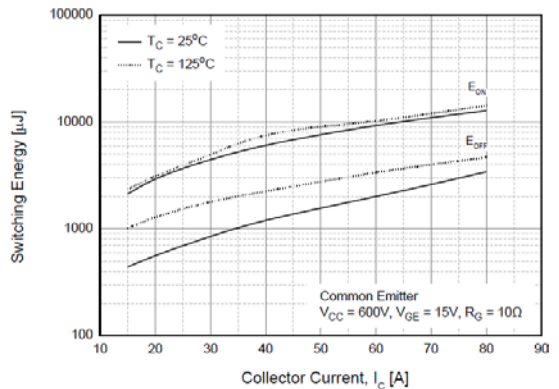

Fig. 12 Switching loss vs. collector current



IGBT Characteristics

Fig. 13 Gate charge characteristics

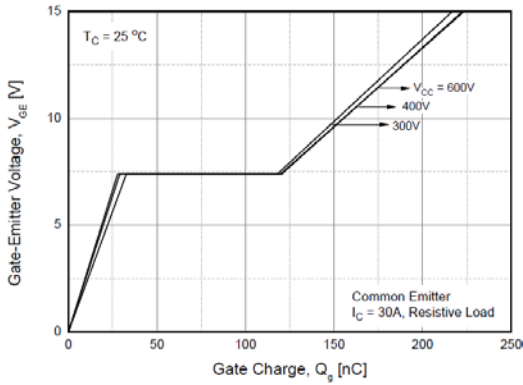

Fig. 14 SOA

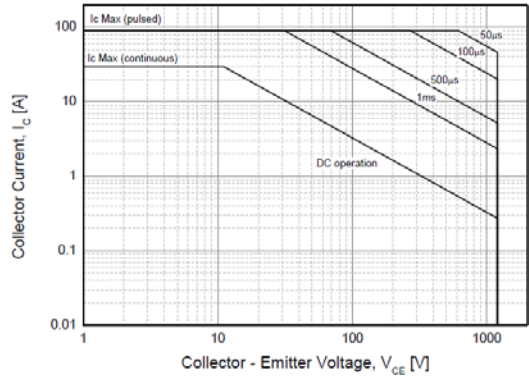

Fig. 15 RBSOA

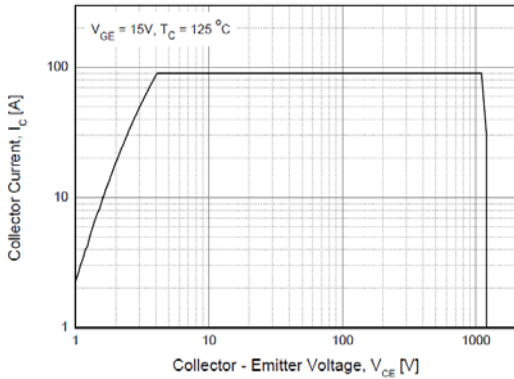

Fig. 16 Transient thermal impedance of IGBT

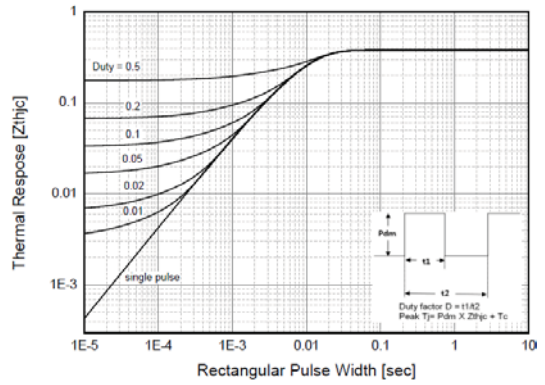
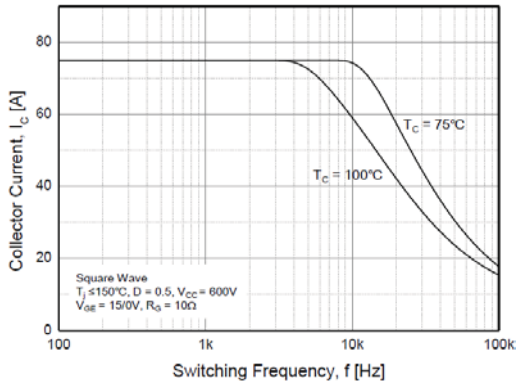

Fig. 17 Load Current vs. Frequency



Diode Characteristics

Fig. 18 Conduction characteristics

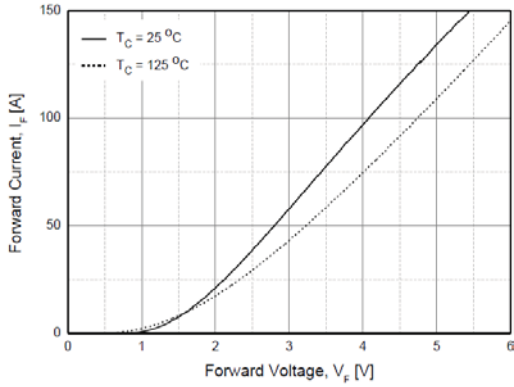

Fig. 19 Reverse recovery current vs. forward current

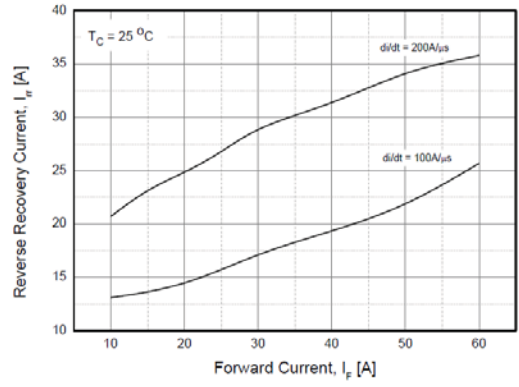

Fig. 20 Reverse recovery charge vs. forward current

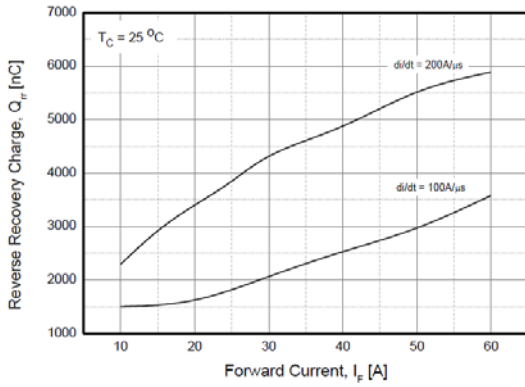
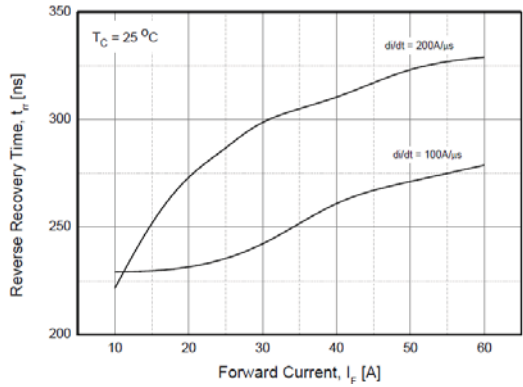

Fig. 21 Reverse recovery time vs. forward current



Package Dimension

TO-3P

