

N-Channel Enhancement Mode MOSFET

Features

- 500V/15A,
 $R_{DS(ON)} = 0.248\Omega(\text{max.}) @ V_{GS} = 10V$
 $V_{DS} @ T_j, \text{max} = 560V (\text{typ.})$
- Reliable and Rugged
- Avalanche Rated
- Lead Free and Green Devices Available (RoHS Compliant)

Pin Description

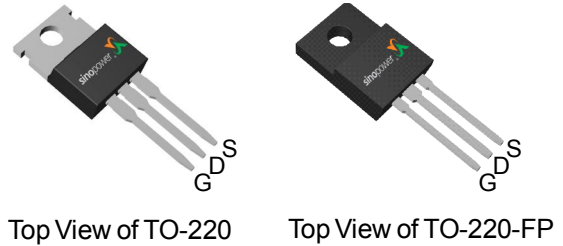

Applications

- AC/DC Power Conversion in Switched Mode Power Supplies (SMPS).
- Uninterruptible Power Supply (UPS),
- Adapter.

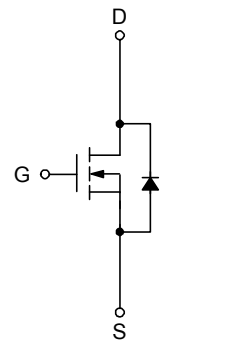

N-Channel MOSFET

Ordering and Marking Information

<p>SM5A26NS □□□-□□□</p> <div style="margin-left: 20px;"> <p>└─ Assembly Material</p> <p>└─ Handling Code</p> <p>└─ Temperature Range</p> <p>└─ Package Code</p> </div>	<p>Package Code F : TO-220 FP : TO-220-FP</p> <p>Operating Junction Temperature Range C : -55 to 150 °C</p> <p>Handling Code TU : Tube (50ea/tube)</p> <p>Assembly Material G : Halogen and Lead Free Device</p>
<p>SM5A26NS F/FP :</p> <div style="border: 1px solid black; padding: 2px; display: inline-block; margin-left: 10px;">  </div>	<p>XXXXX - Lot Code</p>

Note: SINOPOWER lead-free products contain molding compounds/die attach materials and 100% matte tin plate termination finish; which are fully compliant with RoHS. SINOPOWER lead-free products meet or exceed the lead-free requirements of IPC/JEDEC J-STD-020D for MSL classification at lead-free peak reflow temperature. SINOPOWER defines "Green" to mean lead-free (RoHS compliant) and halogen free (Br or Cl does not exceed 900ppm by weight in homogeneous material and total of Br and Cl does not exceed 1500ppm by weight).

SINOPOWER reserves the right to make changes to improve reliability or manufacturability without notice, and advise customers to obtain the latest version of relevant information to verify before placing orders.

Absolute Maximum Ratings (T_A = 25°C Unless Otherwise Noted)

Symbol	Parameter	Rating	Unit	
Common Ratings				
V _{DSS}	Drain-Source Voltage	500	V	
V _{GSS}	Gate-Source Voltage	±30		
T _J	Maximum Junction Temperature	150	°C	
T _{STG}	Storage Temperature Range	-55 to 150	°C	
I _S	Diode Continuous Forward Current	15 ^a	A	
I _{DP} ^b	Pulse Drain Current Tested	T _C =25°C	60 ^a	A
I _D	Continuous Drain Current	T _C =25°C	15 ^a	A
		T _C =100°C	9.5 ^a	
P _D	Maximum Power Dissipation for TO-220	T _C =25°C	139	W
		T _C =100°C	55	
P _D	Maximum Power Dissipation for TO-220FP	T _C =25°C	32.9	
		T _C =100°C	13.1	
R _{θJC}	Thermal Resistance-Junction to Case for TO-220	0.9	°C/W	
R _{θJC}	Thermal Resistance-Junction to Case for TO-220FP	3.8		
R _{θJA}	Thermal Resistance-Junction to Ambient	62.5		
Drain-Source Avalanche Ratings				
dv/dt ^c	MOSFET dv/dt ruggedness	50	V/ns	
E _{AS} ^d	Avalanche Energy, Single Pulsed	250	mJ	
I _{AR} ^e	Avalanche Current	2.5	A	
E _{AR} ^e	Repetitive Avalanche Energy	0.59	mJ	

Note a : Limited by maximum junction temperature.

Note b : Pulse width limited by safe operating area.

Note c : V_{DS}=400V, I_D=15A.

Note d : I_D=2.5A, V_{DD}=50V, T_J=25°C.

Note e : Repetitive Rating : Pulse width limited by maximum junction temperature.

Electrical Characteristics (T_A = 25°C Unless Otherwise Noted)

Symbol	Parameter	Test Conditions	Min.	Typ.	Max.	Unit
Static Characteristics						
BV _{DSS}	Drain-Source Breakdown Voltage	V _{GS} =0V, I _{DS} =250μA	500	-	-	V
		T _J =150°C	-	560	-	
I _{DSS}	Zero Gate Voltage Drain Current	V _{DS} =400V, V _{GS} =0V	-	-	1	μA
		T _J =150°C	-	-	200	
V _{GS(th)}	Gate Threshold Voltage	V _{DS} =V _{GS} , I _{DS} =250μA	2.5	3.5	4.5	V
I _{GSS}	Gate Leakage Current	V _{GS} =±30V, V _{DS} =0V	-	-	±100	nA
R _{DS(ON)} ^f	Drain-Source On-state Resistance	V _{GS} =10V, I _{DS} =6A	-	0.205	0.248	Ω
Diode Characteristics						
V _{SD} ^f	Diode Forward Voltage	I _{SD} =15A, V _{GS} =0V	-	0.93	1.3	V
t _{rr}	Reverse Recovery Time	I _{SD} =15A, V _R =360V dI _{SD} /dt=100A/μs	-	280	-	ns
Q _{rr}	Reverse Recovery Charge		-	3.3	-	μC
I _{rm}	Peak Reverse Recovery Current		-	24	-	A
Dynamic Characteristics^g						
R _G	Gate Resistance	V _{GS} =0V, V _{DS} =0V, F=1MHz	-	2.3	-	Ω
C _{iss}	Input Capacitance	V _{GS} =0V, V _{DS} =25V, Frequency=1.0MHz	-	1060	1380	pF
C _{oss}	Output Capacitance		-	890	-	
C _{rss}	Reverse Transfer Capacitance		-	28	-	
t _{d(ON)}	Turn-on Delay Time	V _{DD} =400V, R _L =26Ω, I _{DS} =15A, V _{GEN} =10V, R _G =15Ω	-	13	-	ns
T _r	Turn-on Rise Time		-	36	-	
t _{d(OFF)}	Turn-off Delay Time		-	32	-	
T _f	Turn-off Fall Time		-	30	-	
Gate Charge Characteristics^g						
Q _g	Total Gate Charge	V _{DS} =400V, V _{GS} =10V, I _{DS} =6A	-	30.5	40	nC
Q _{gs}	Gate-Source Charge		-	6	-	
Q _{gd}	Gate-Drain Charge		-	14	-	

Note f : Pulse test ; pulse width≤300μs, duty cycle≤2%.

Note g : Guaranteed by design, not subject to production testing.

Typical Operating Characteristics

Power Dissipation : TO-220

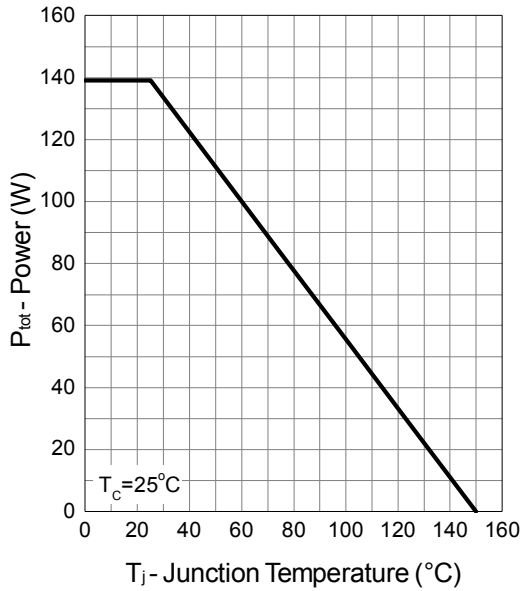

Power Dissipation : TO-220FP

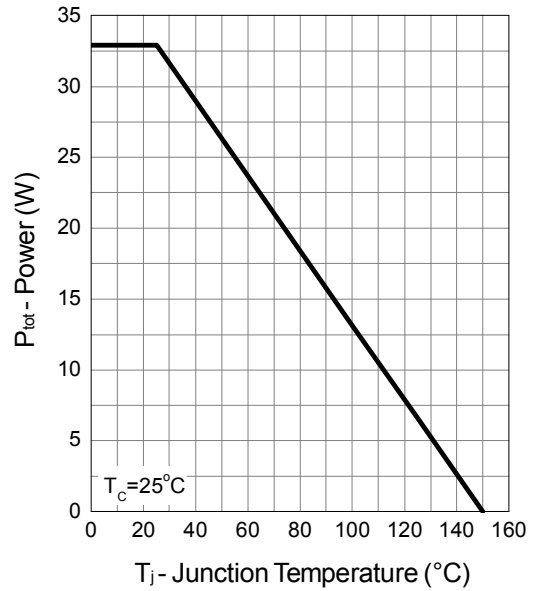

Safe Operation Area : TO-220

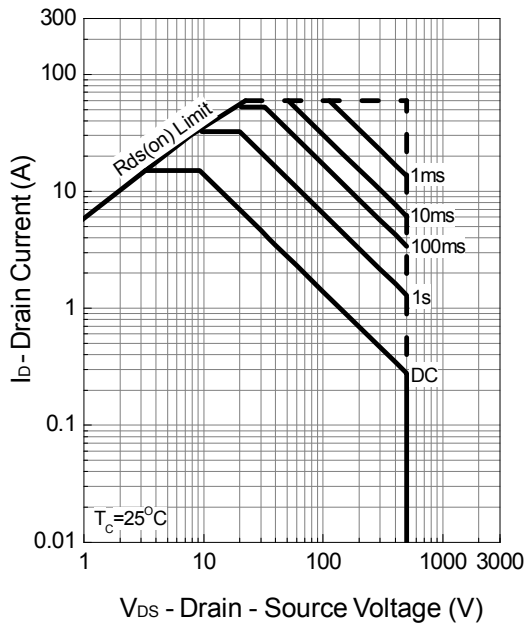

Safe Operation Area : TO-220FP

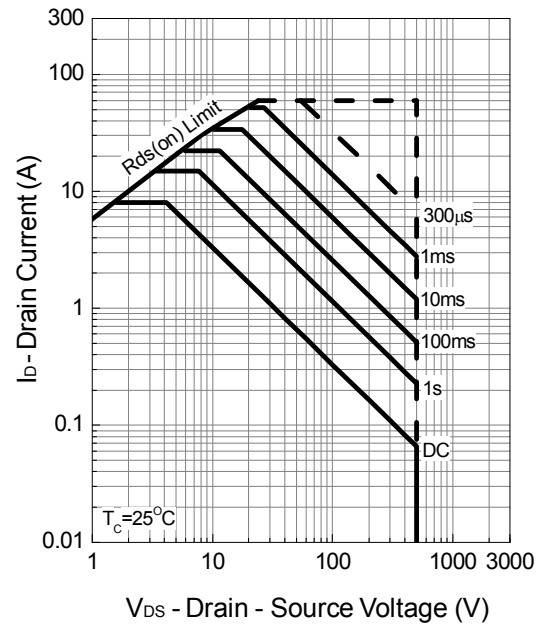

Typical Operating Characteristics (Cont.)

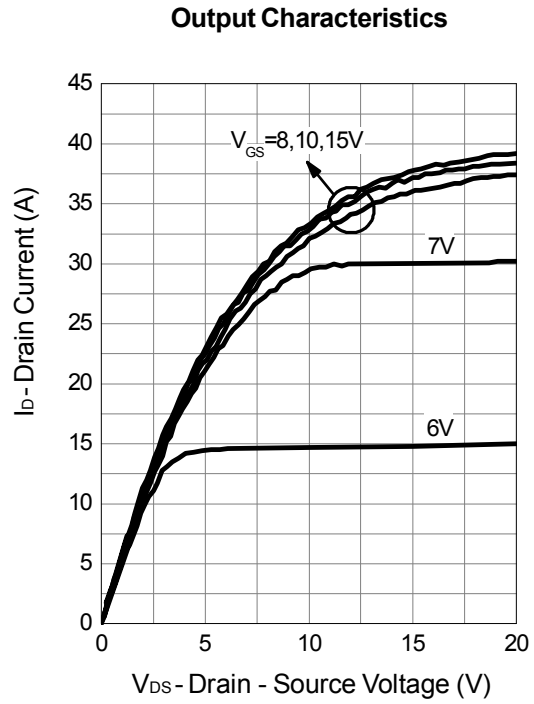
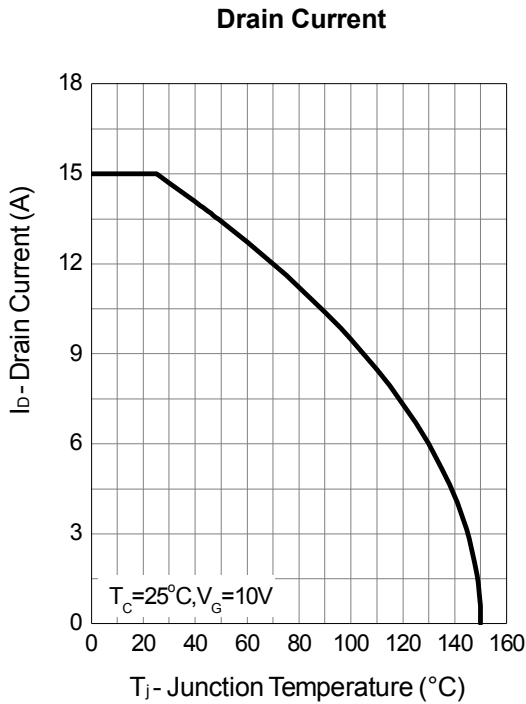
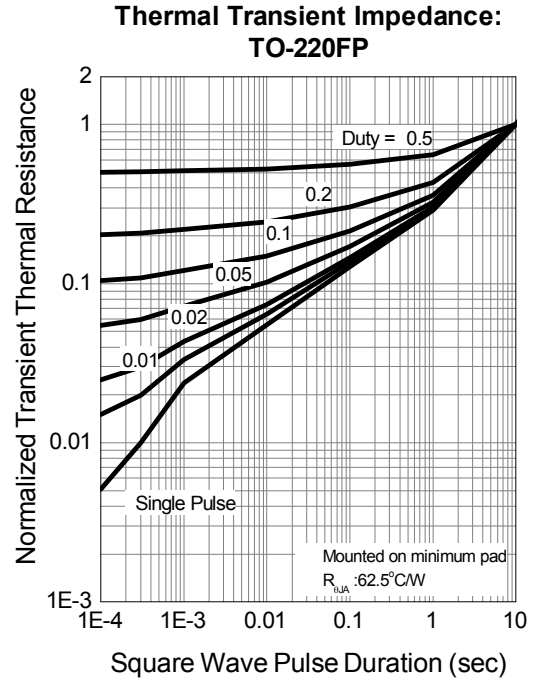
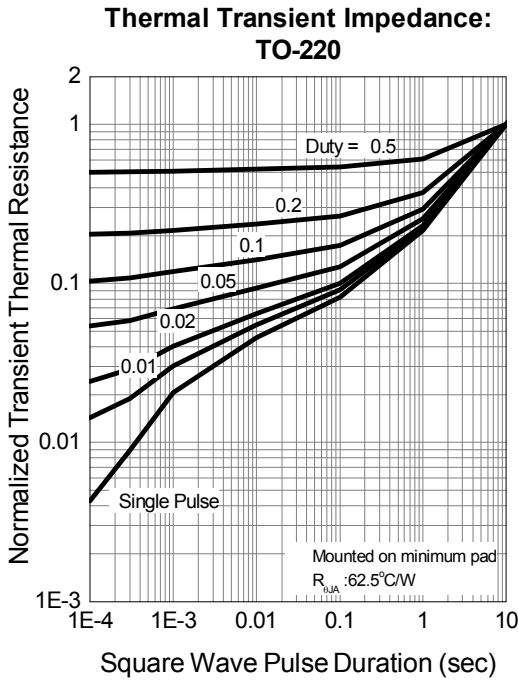

Typical Operating Characteristics (Cont.)

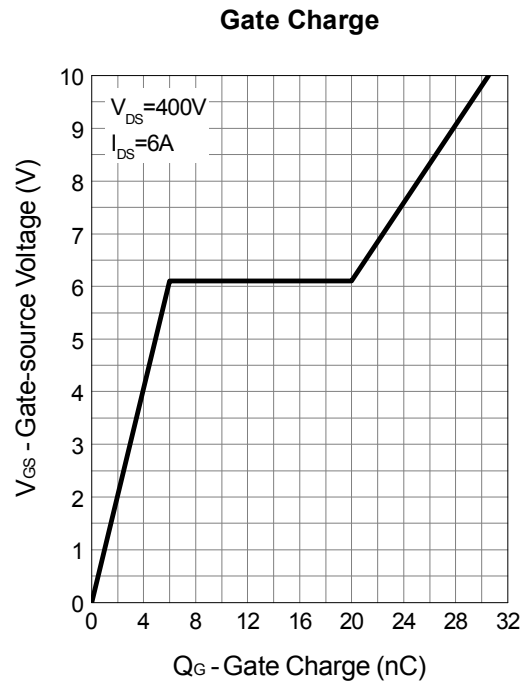
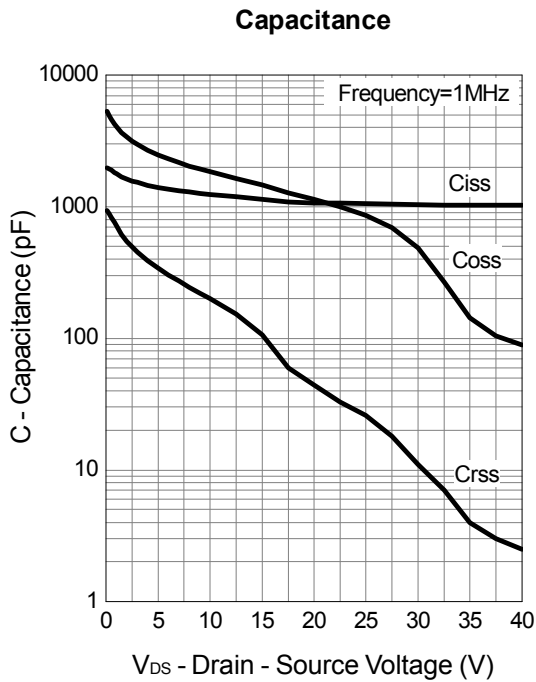
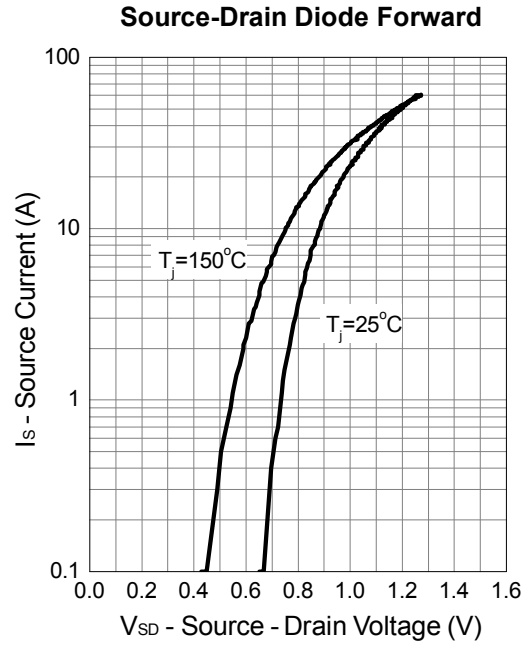
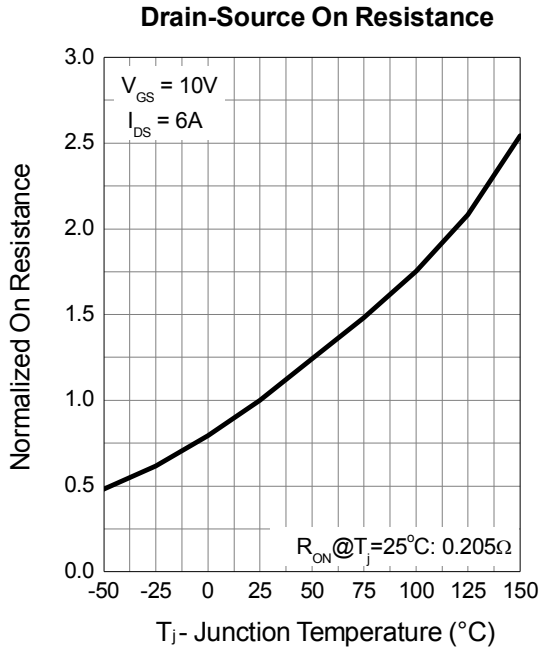

Typical Operating Characteristics (Cont.)

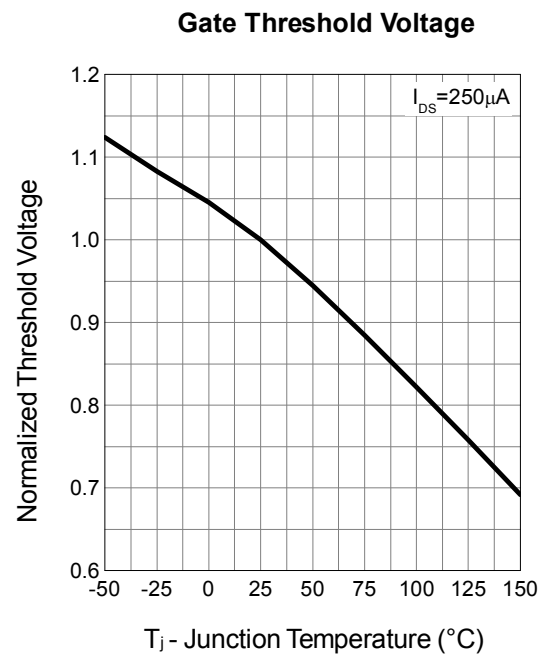
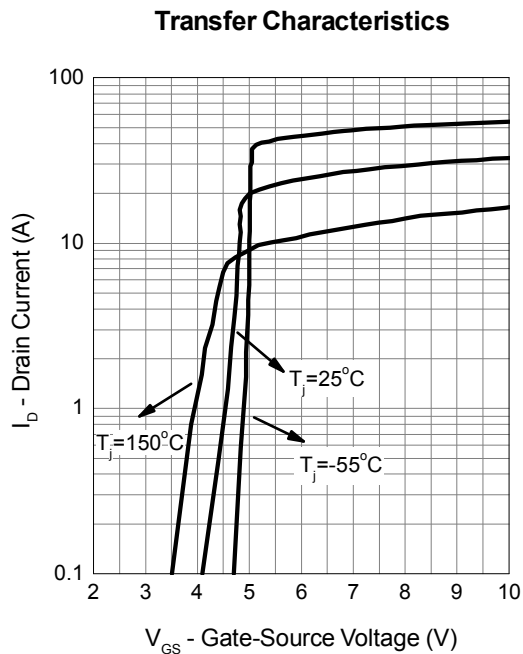
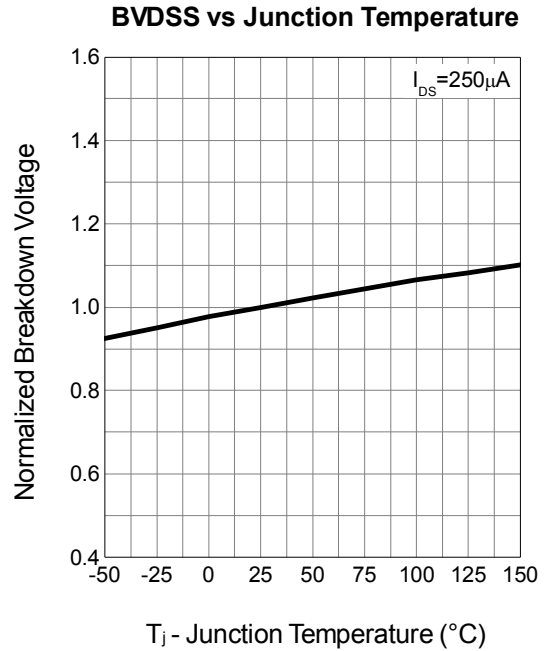
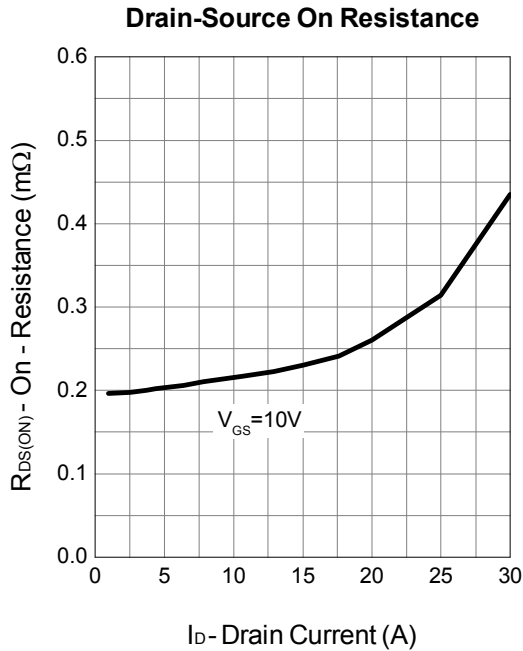

Avalanche Test Circuit and Waveforms

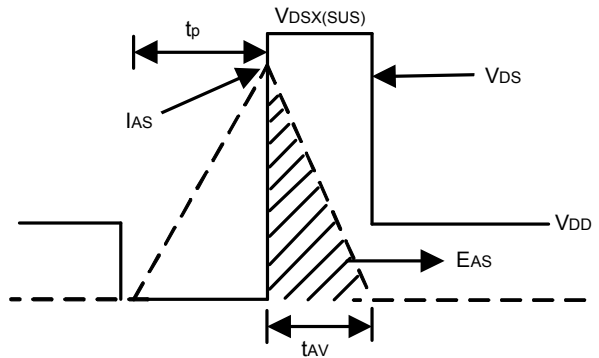
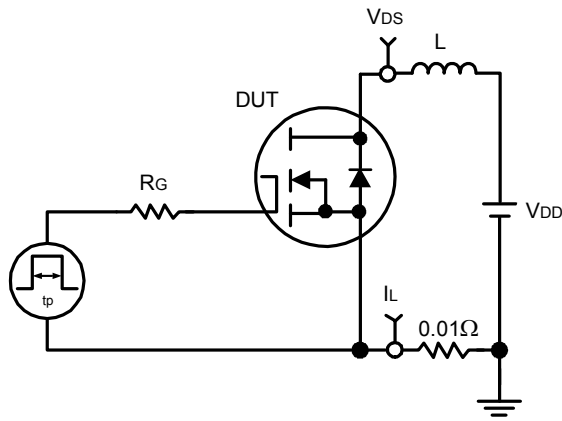

Switching Time Test Circuit and Waveforms

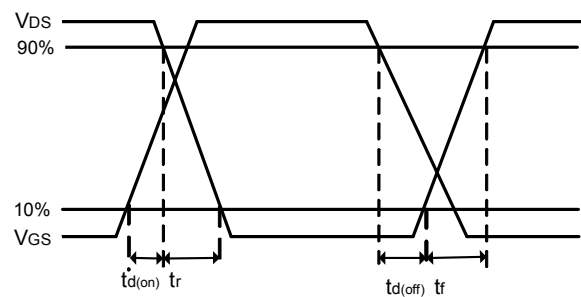
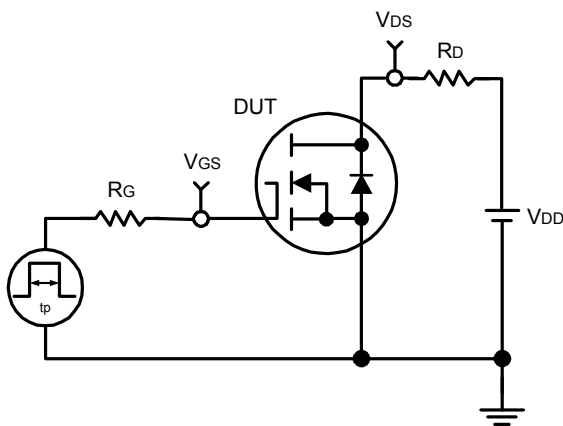

Package Information

TO-220

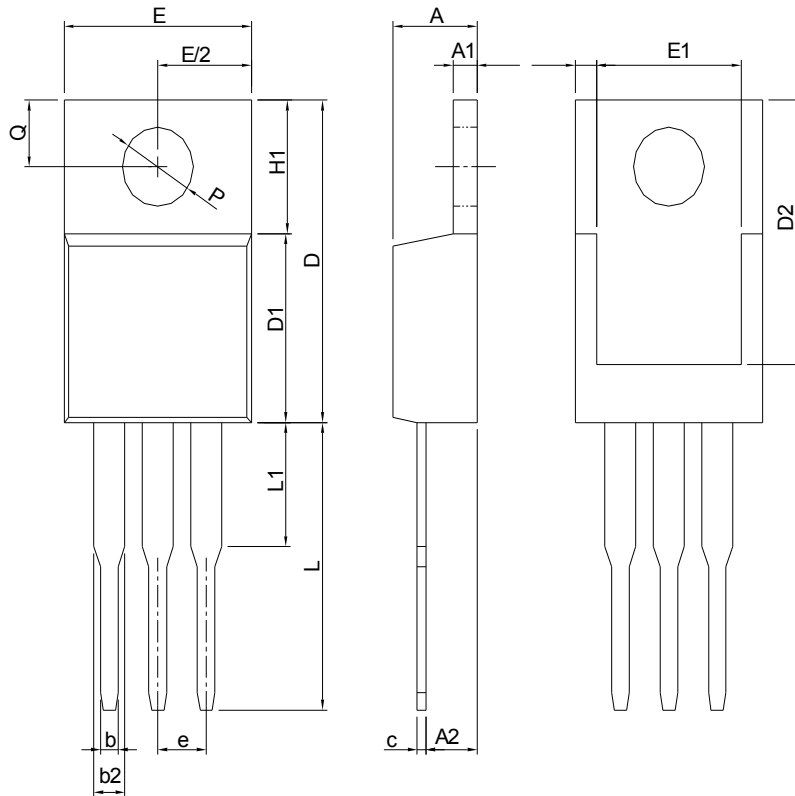

SYMBOL	TO-220			
	MILLIMETERS		INCHES	
	MIN.	MAX.	MIN.	MAX.
A	3.56	4.83	0.140	0.190
A1	0.51	1.40	0.020	0.055
A2	2.03	2.92	0.080	0.115
b	0.38	1.02	0.015	0.040
b2	1.14	1.78	0.045	0.070
c	0.36	0.61	0.014	0.024
D	14.22	16.51	0.560	0.650
D1	8.38	9.02	0.330	0.355
D2	12.19	13.65	0.480	0.537
E	9.65	10.67	0.380	0.420
E1	6.86	8.89	0.270	0.350
e	2.54 BSC		0.100 BSC	
H1	5.84	6.86	0.230	0.270
L	12.70	14.73	0.500	0.580
L1		6.35		0.250
P	3.53	4.09	0.139	0.161
Q	2.54	3.43	0.100	0.135

RECOMMENDED LAND PATTERN

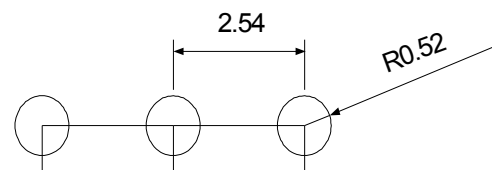

UNIT: mm

Note: Follow JEDEC TO-220 AB.

Package Information

TO-220-FP

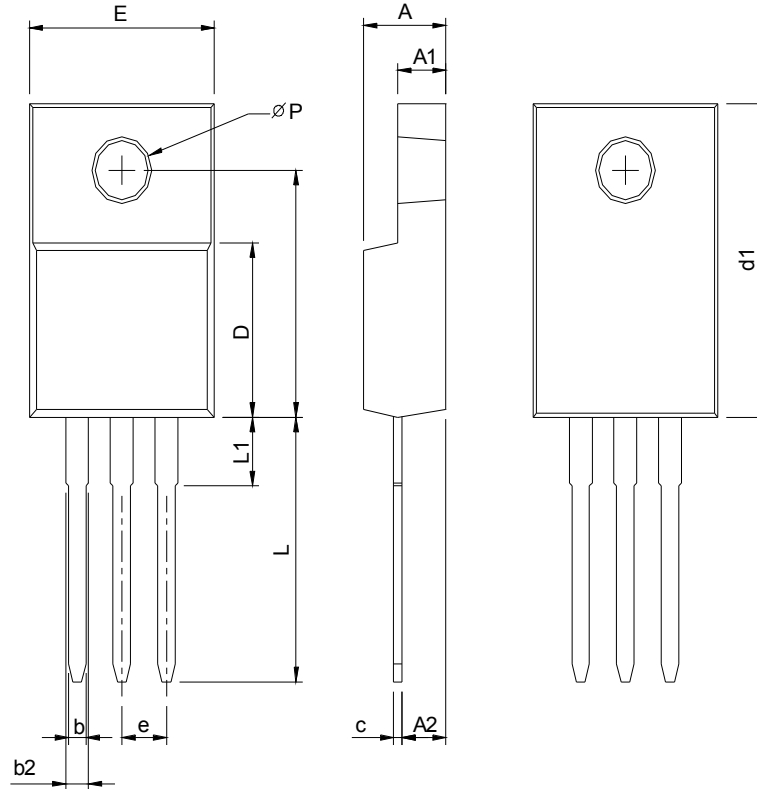

SYMBOL	TO-220FP			
	MILLIMETERS		INCHES	
	MIN.	MAX.	MIN.	MAX.
A	4.20	4.80	0.165	0.189
A1	2.60	3.20	0.102	0.126
A2	2.10	2.90	0.083	0.114
b	0.50	1.00	0.020	0.039
b2	0.90	1.90	0.035	0.075
c	0.30	0.80	0.012	0.031
D	8.10	9.10	0.319	0.358
d1	14.50	16.50	0.571	0.650
d2	12.10	12.90	0.476	0.508
E	9.70	10.70	0.382	0.421
e	2.54 BSC		0.100 BSC	
L	13.00	14.50	0.512	0.570
L1	1.60	4.00	0.063	0.157
P	3.00	3.60	0.118	0.142

RECOMMENDED LAND PATTERN

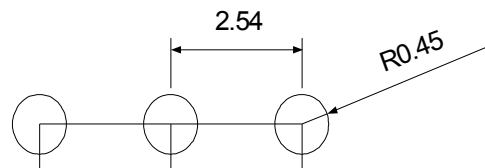

UNIT: mm

Classification Profile

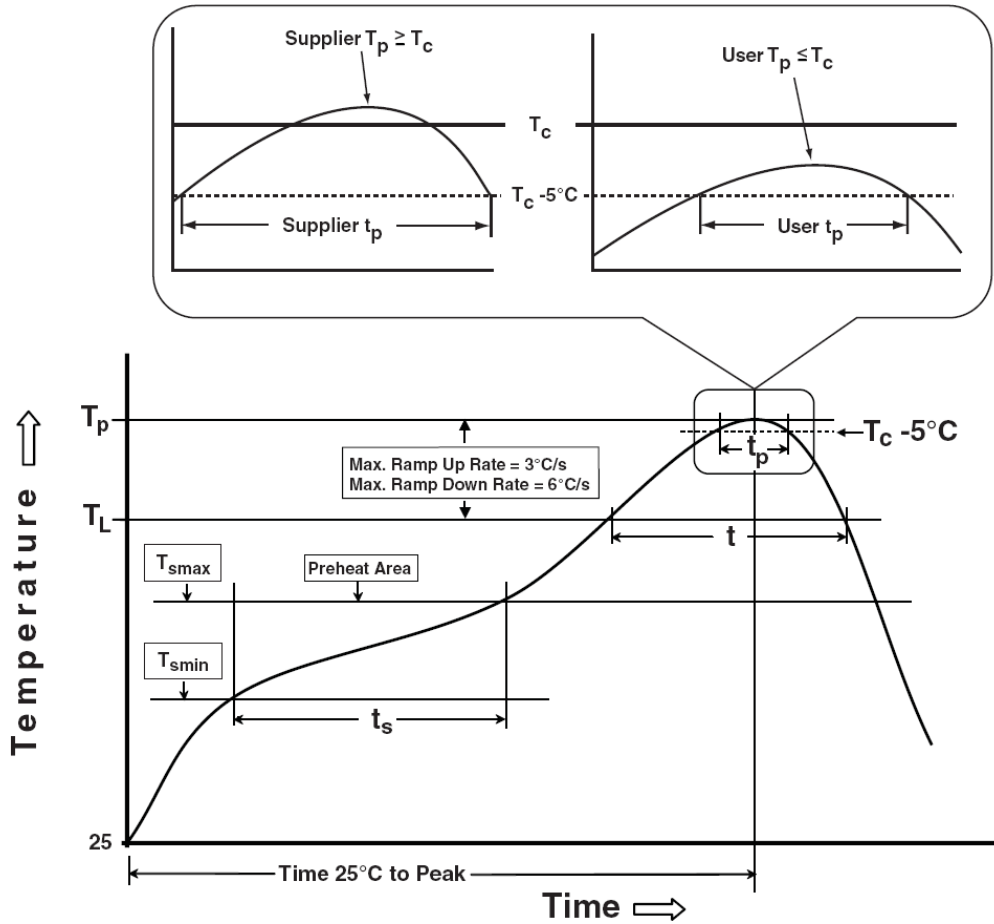

Classification Reflow Profiles

Profile Feature	Sn-Pb Eutectic Assembly	Pb-Free Assembly
Preheat & Soak		
Temperature min (T_{smin})	100 °C	150 °C
Temperature max (T_{smax})	150 °C	200 °C
Time (T_{smin} to T_{smax}) (t_s)	60-120 seconds	60-120 seconds
Average ramp-up rate (T_{smax} to T_p)	3 °C/second max.	3°C/second max.
Liquidous temperature (T_L)	183 °C	217 °C
Time at liquidous (t_L)	60-150 seconds	60-150 seconds
Peak package body Temperature (T_p)*	See Classification Temp in table 1	See Classification Temp in table 2
Time (t_p)** within 5°C of the specified classification temperature (T_c)	20** seconds	30** seconds
Average ramp-down rate (T_p to T_{smax})	6 °C/second max.	6 °C/second max.
Time 25°C to peak temperature	6 minutes max.	8 minutes max.
* Tolerance for peak profile Temperature (T_p) is defined as a supplier minimum and a user maximum.		
** Tolerance for time at peak profile temperature (t_p) is defined as a supplier minimum and a user maximum.		

Table 1. SnPb Eutectic Process – Classification Temperatures (T_c)

Package Thickness	Volume mm ³ <350	Volume mm ³ ≥350
<2.5 mm	235 °C	220 °C
≥2.5 mm	220 °C	220 °C

Table 2. Pb-free Process – Classification Temperatures (T_c)

Package Thickness	Volume mm ³ <350	Volume mm ³ 350-2000	Volume mm ³ >2000
<1.6 mm	260 °C	260 °C	260 °C
1.6 mm – 2.5 mm	260 °C	250 °C	245 °C
≥2.5 mm	250 °C	245 °C	245 °C

Reliability Test Program

Test item	Method	Description
SOLDERABILITY	JESD-22, B102	5 Sec, 245°C
HTRB	JESD-22, A108	1000 Hrs, 80% of VDS max @ T_{jmax}
HTGB	JESD-22, A108	1000 Hrs, 100% of VGS max @ T_{jmax}
PCT	JESD-22, A102	168 Hrs, 100%RH, 2atm, 121°C
TCT	JESD-22, A104	500 Cycles, -65°C~150°C

Customer Service

Sinopower Semiconductor, Inc.

5F, No. 6, Dusing 1St Rd., Hsinchu Science Park,

Hsinchu, 30078, Taiwan

TEL: 886-3-5635818 Fax: 886-3-5642050