

N-Channel Enhancement Mode MOSFET

Features

- 30V/25A,
 $R_{DS(ON)} = 16m\Omega(\text{max.}) @ V_{GS} = 10V$
 $R_{DS(ON)} = 21.5m\Omega(\text{max.}) @ V_{GS} = 4.5V$
- Avalanche Rated
- Reliable and Rugged
- Lead Free and Green Devices Available
 (RoHS Compliant)

Applications

- Power Management in Notebook Computer, Portable Equipment and Battery Powered Systems.

Pin Description

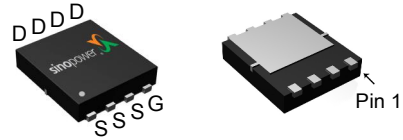

DFN3x3-8

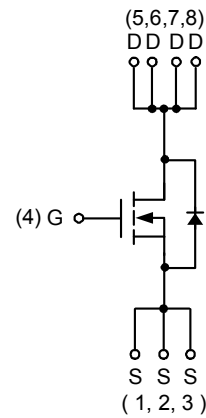

N-Channel MOSFET

Ordering and Marking Information

| | |
|--|---|
| <p>SM3316NS □□□-□□□</p> <div style="margin-left: 20px;"> <p>└─ Assembly Material</p> <p>└─ Handling Code</p> <p>└─ Temperature Range</p> <p>└─ Package Code</p> </div> | <p>Package Code QA : DFN3x3-8</p> <p>Operating Junction Temperature Range C : -55 to 150 °C</p> <p>Handling Code TR : Tape & Reel (3000ea/reel)</p> <p>Assembly Material G : Halogen and Lead Free Device</p> |
| <p>SM3316NS QA :</p> <div style="border: 1px solid black; padding: 2px; display: inline-block; margin-left: 10px;"> SM 3316 XXXXX </div> | <p>XXXXX - Lot Code</p> |

Note : SINOPOWER lead-free products contain molding compounds/die attach materials and 100% matte tin plate termination finish; which are fully compliant with RoHS. SINOPOWER lead-free products meet or exceed the lead-free requirements of IPC/JEDEC J-STD-020D for MSL classification at lead-free peak reflow temperature. SINOPOWER defines "Green" to mean lead-free (RoHS compliant) and halogen free (Br or Cl does not exceed 900ppm by weight in homogeneous material and total of Br and Cl does not exceed 1500ppm by weight).

SINOPOWER reserves the right to make changes to improve reliability or manufacturability without notice, and advise customers to obtain the latest version of relevant information to verify before placing orders.

Absolute Maximum Ratings ($T_A = 25^\circ\text{C}$ Unless Otherwise Noted)

| Symbol | Parameter | Rating | Unit | |
|-------------------|--|------------------------|------------------|--------------------|
| V_{DSS} | Drain-Source Voltage | 30 | V | |
| V_{GSS} | Gate-Source Voltage | ± 20 | | |
| I_D^a | Continuous Drain Current ($V_{GS}=10\text{V}$) | $T_A=25^\circ\text{C}$ | 10 | A |
| | | $T_A=70^\circ\text{C}$ | 8 | |
| I_{DM}^a | Pulsed Drain Current ($V_{GS}=10\text{V}$) | $T_A=25^\circ\text{C}$ | 40 | |
| I_D^c | Continuous Drain Current ($V_{GS}=10\text{V}$) | $T_C=25^\circ\text{C}$ | 25 | |
| | | $T_C=70^\circ\text{C}$ | 17 | |
| I_{DM}^c | Pulsed Drain Current ($V_{GS}=10\text{V}$) | $T_C=25^\circ\text{C}$ | 50 | |
| I_S^a | Diode Continuous Forward Current | 1 | | |
| I_{AS}^b | Avalanche Current, Single pulse | $L=0.1\text{mH}$ | 17 | |
| E_{AS}^b | Avalanche Energy, Single pulse | $L=0.1\text{mH}$ | 14 | mJ |
| T_J | Maximum Junction Temperature | 150 | $^\circ\text{C}$ | |
| T_{STG} | Storage Temperature Range | -55 to 150 | | |
| P_D^a | Maximum Power Dissipation | $T_A=25^\circ\text{C}$ | 2.5 | W |
| | | $T_A=70^\circ\text{C}$ | 1.6 | |
| P_D^c | Maximum Power Dissipation | $T_C=25^\circ\text{C}$ | 22 | |
| | | $T_C=70^\circ\text{C}$ | 10 | |
| $R_{\theta JA}^a$ | Thermal Resistance-Junction to Ambient | $t \leq 10\text{s}$ | 50 | $^\circ\text{C/W}$ |
| | | Steady State | 70 | |
| $R_{\theta JC}^c$ | Thermal Resistance-Junction to Case | Steady State | 5.5 | |

Note a : Surface Mounted on 1in^2 pad area, $t \leq 10\text{sec}$.

Note b : UIS tested and pulse width limited by maximum junction temperature 150°C (initial temperature $T_J=25^\circ\text{C}$).

Note c : The power dissipation P_D is based on $T_{J(\text{MAX})} = 150^\circ\text{C}$, and it is useful for reducing junction-to-case thermal resistance ($R_{\theta JC}$) when additional heat sink is used.

Electrical Characteristics (T_A = 25°C Unless Otherwise Noted)

| Symbol | Parameter | Test Conditions | Min. | Typ. | Max. | Unit |
|--|----------------------------------|---|------|------|------|------|
| Static Characteristics | | | | | | |
| BV _{DSS} | Drain-Source Breakdown Voltage | V _{GS} =0V, I _{DS} =250μA | 30 | - | - | V |
| I _{DSS} | Zero Gate Voltage Drain Current | V _{DS} =24V, V _{GS} =0V | - | - | 1 | μA |
| | | T _J =85°C | - | - | 30 | |
| V _{GS(th)} | Gate Threshold Voltage | V _{DS} =V _{GS} , I _{DS} =250μA | 1.3 | 1.9 | 2.5 | V |
| I _{GSS} | Gate Leakage Current | V _{GS} =±20V, V _{DS} =0V | - | - | ±100 | nA |
| R _{DS(ON)} ^a | Drain-Source On-state Resistance | V _{GS} =10V, I _{DS} =8A | - | 13.3 | 16 | mΩ |
| | | V _{GS} =4.5V, I _{DS} =8A | - | 17.5 | 21.5 | |
| Diode Characteristics | | | | | | |
| V _{SD} ^a | Diode Forward Voltage | I _{SD} =1A, V _{GS} =0V | - | 0.7 | 1.1 | V |
| t _{rr} ^b | Reverse Recovery Time | I _{SD} =8A, dI _{SD} /dt=100A/μs | - | 15.9 | - | ns |
| Q _{rr} ^b | Reverse Recovery Charge | | - | 7 | - | nC |
| Dynamic Characteristics^b | | | | | | |
| R _G | Gate Resistance | V _{GS} =0V, V _{DS} =0V, F=1MHz | 3 | 4 | 5 | Ω |
| C _{iss} | Input Capacitance | V _{GS} =0V, V _{DS} =15V, Frequency=1.0MHz | 420 | 540 | 620 | pF |
| C _{oss} | Output Capacitance | | 80 | 100 | 130 | |
| C _{rss} | Reverse Transfer Capacitance | | 30 | 50 | 70 | |
| t _{d(ON)} | Turn-on Delay Time | V _{DD} =15V, R _L =15Ω, I _{DS} =1A, V _{GEN} =10V, R _G =6Ω | - | 5.5 | 9.6 | ns |
| t _r | Turn-on Rise Time | | - | 10 | 17 | |
| t _{d(OFF)} | Turn-off Delay Time | | - | 20 | 36 | |
| t _f | Turn-off Fall Time | | - | 3.2 | 7.7 | |
| Gate Charge Characteristics^b | | | | | | |
| Q _g | Total Gate Charge | V _{DS} =15V, V _{GS} =10V, I _{DS} =8A | - | 9.9 | 12 | nC |
| Q _g | Total Gate Charge | V _{DS} =15V, V _{GS} =4.5V, I _{DS} =8A | - | 5 | 5.5 | |
| Q _{gth} | Threshold Gate Charge | | - | 1.4 | 1.9 | |
| Q _{gs} | Gate-Source Charge | | - | 2 | 2.3 | |
| Q _{gd} | Gate-Drain Charge | | - | 1.8 | 2.8 | |

Note a : Pulse test ; pulse width ≤ 300 μs, duty cycle ≤ 2%.

Note b : Guaranteed by design, not subject to production testing.

Typical Operating Characteristics

Power Dissipation

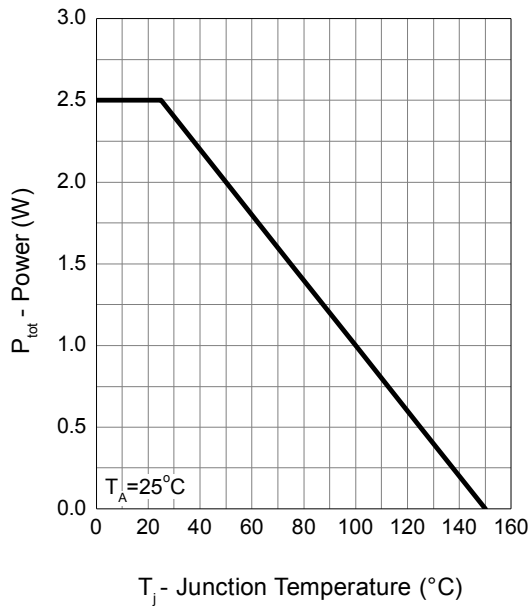

Drain Current

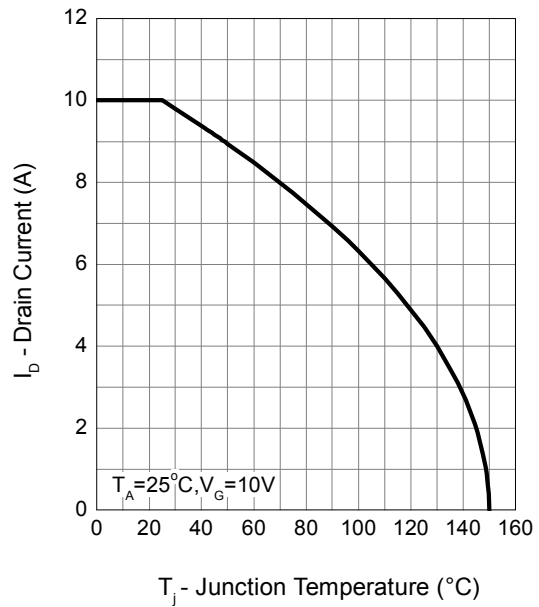

Safe Operation Area

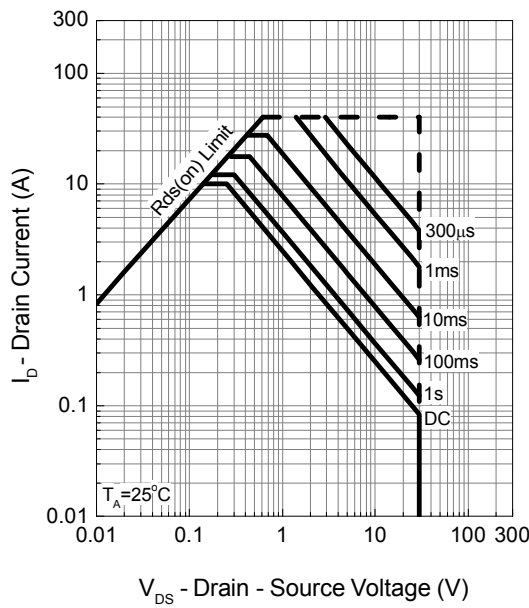

Thermal Transient Impedance

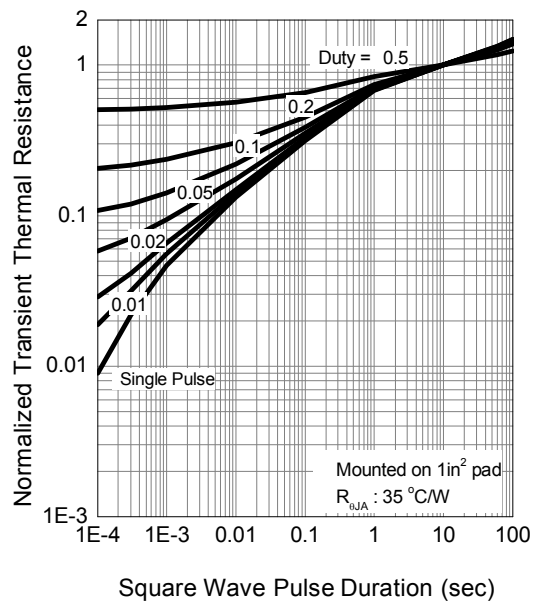

Typical Operating Characteristics (Cont.)

Power Dissipation

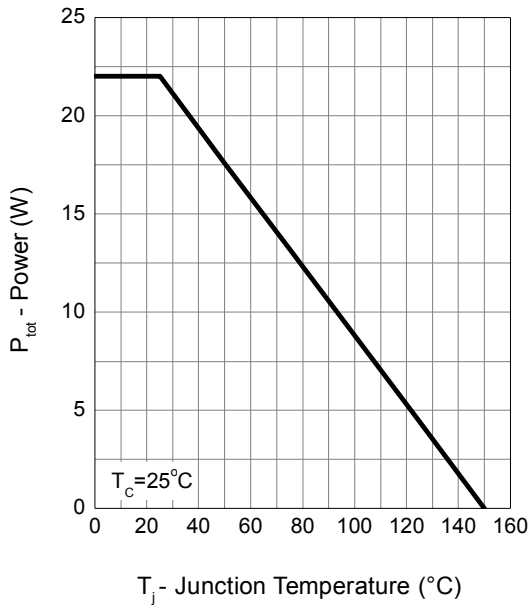

Drain Current

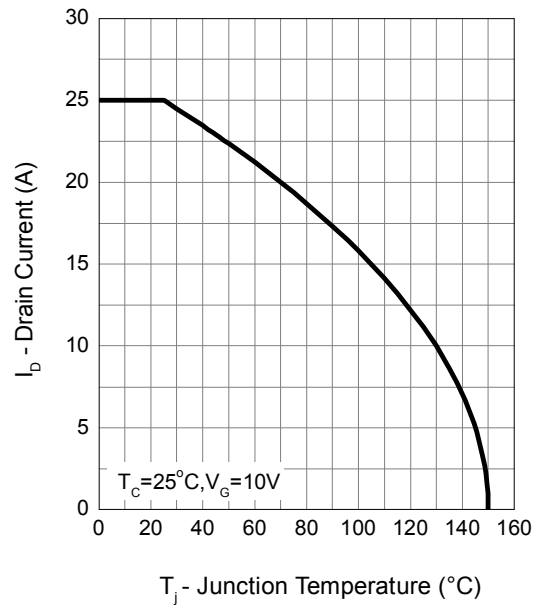

Safe Operation Area

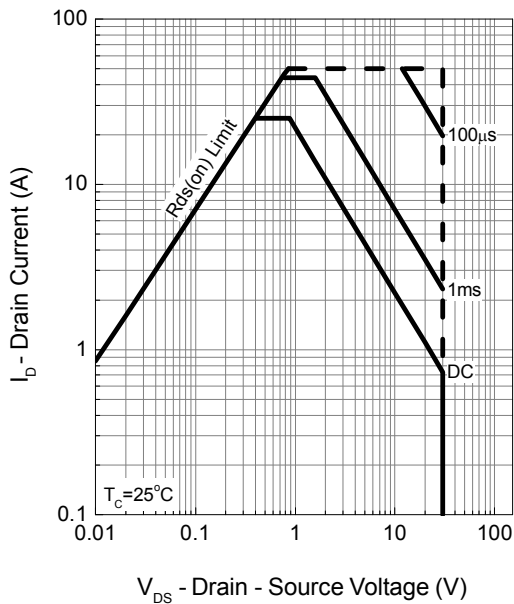

Thermal Transient Impedance

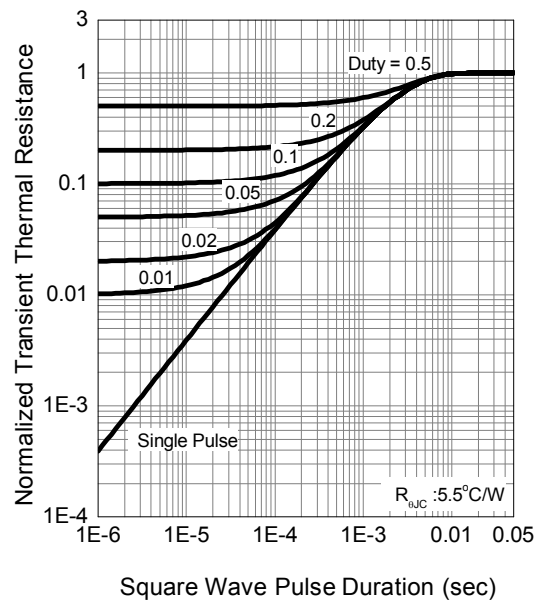

Typical Operating Characteristics (Cont.)

Output Characteristics

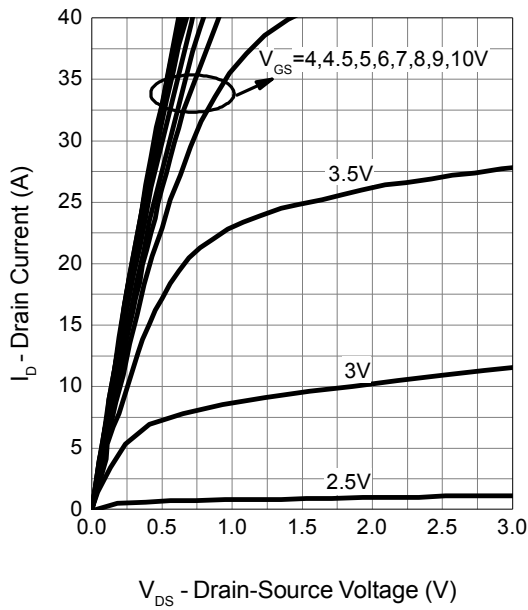

Drain-Source On Resistance

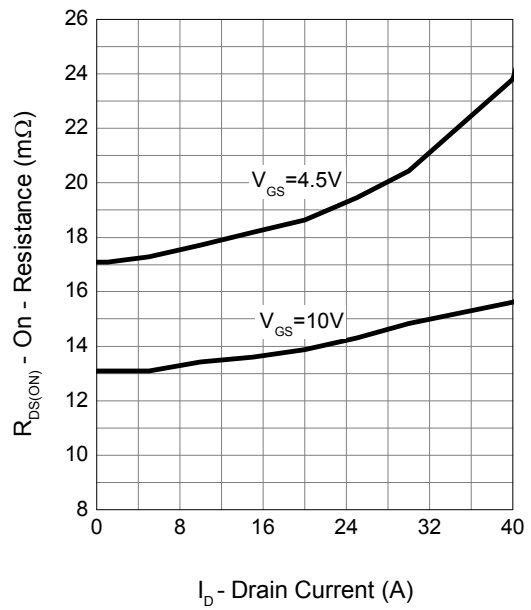

Gate-Source On Resistance

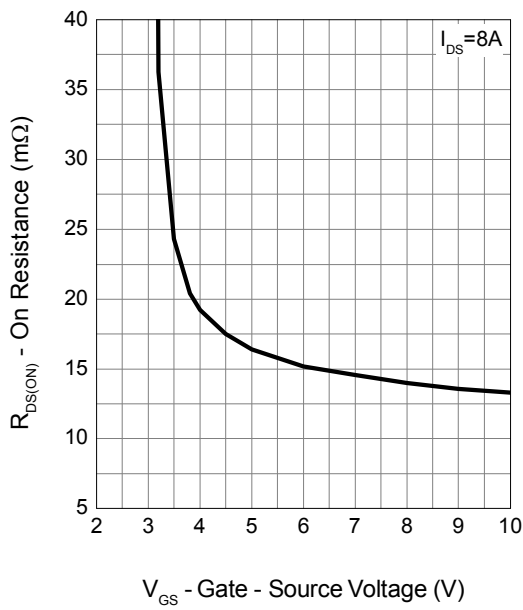

Gate Threshold Voltage

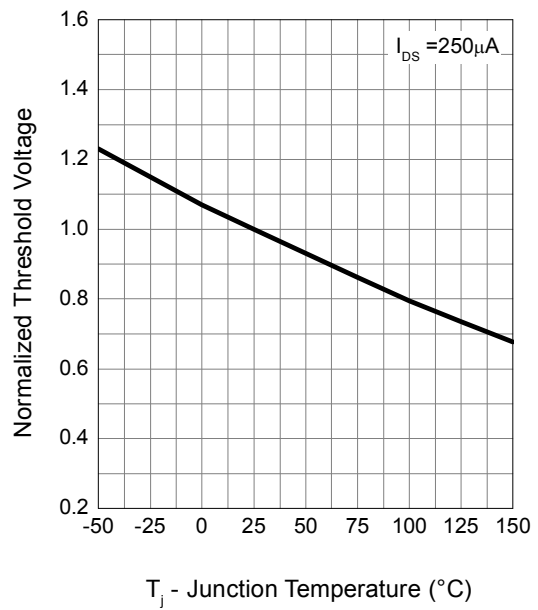

Typical Operating Characteristics (Cont.)

Drain-Source On Resistance

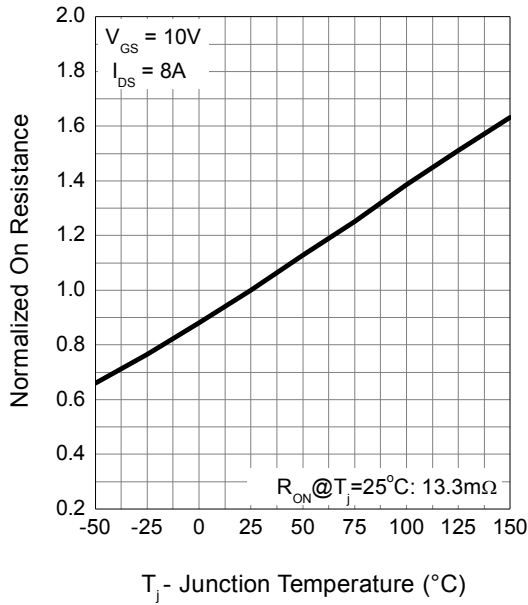

Source-Drain Diode Forward

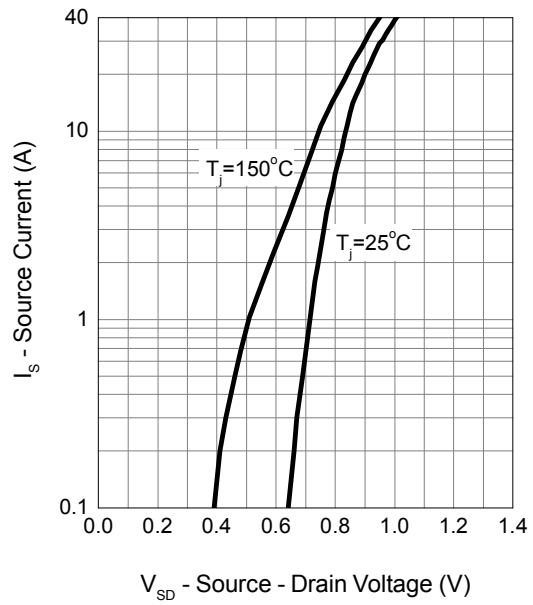

Capacitance

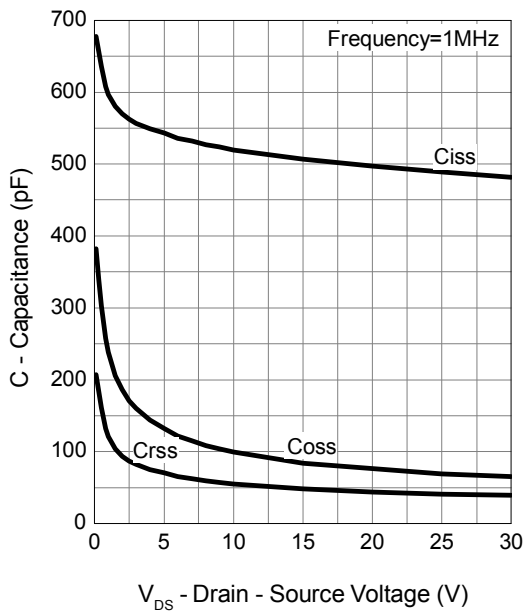

Gate Charge

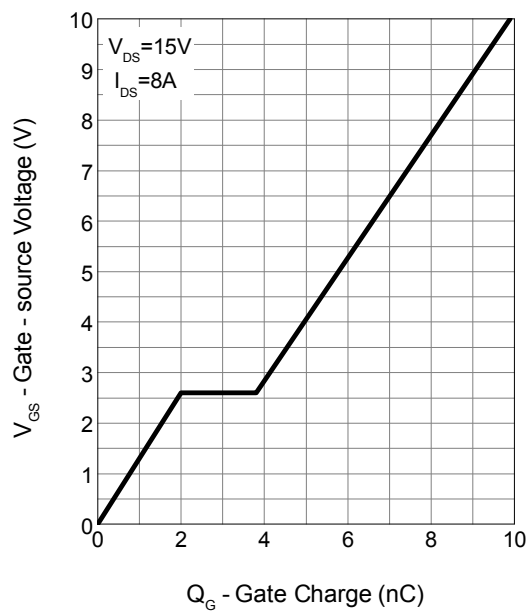

Typical Operating Characteristics (Cont.)

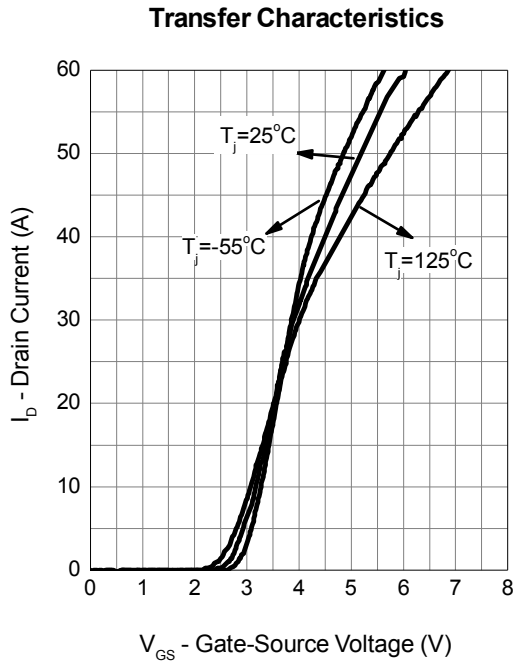

Package Information

DFN3x3-8

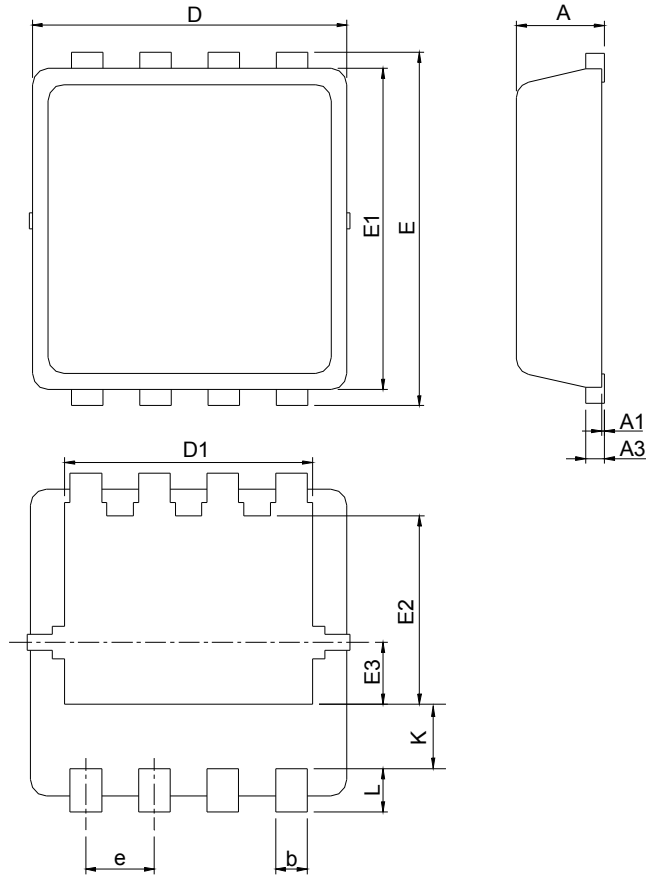

| SYMBOL | DFN3x3-8 | | | |
|--------|-------------|-------|-----------|-------|
| | MILLIMETERS | | INCHES | |
| | MIN. | MAX. | MIN. | MAX. |
| A | 0.80 | 1.00 | 0.031 | 0.039 |
| A1 | 0.00 | 0.05 | 0.000 | 0.002 |
| A3 | 0.10 | 0.25 | 0.004 | 0.010 |
| b | 0.24 | 0.35 | 0.009 | 0.014 |
| D | 2.90 | 3.10 | 0.114 | 0.122 |
| D1 | 2.25 | 2.45 | 0.089 | 0.096 |
| E | 3.10 | 3.30 | 0.122 | 0.130 |
| E1 | 2.90 | 3.10 | 0.114 | 0.122 |
| E2 | 1.65 | 1.85 | 0.065 | 0.073 |
| E3 | 0.56 | 0.58 | 0.022 | 0.023 |
| e | 0.65 BSC | | 0.026 BSC | |
| K | 0.475 | 0.775 | 0.019 | 0.031 |
| L | 0.30 | 0.50 | 0.012 | 0.020 |

RECOMMENDED LAND PATTERN

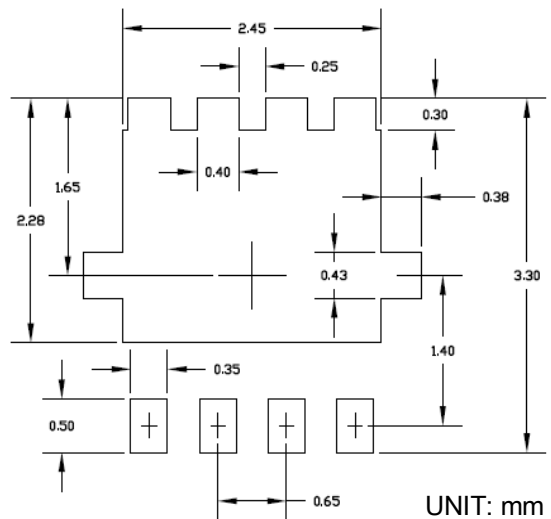

Carrier Tape & Reel Dimensions

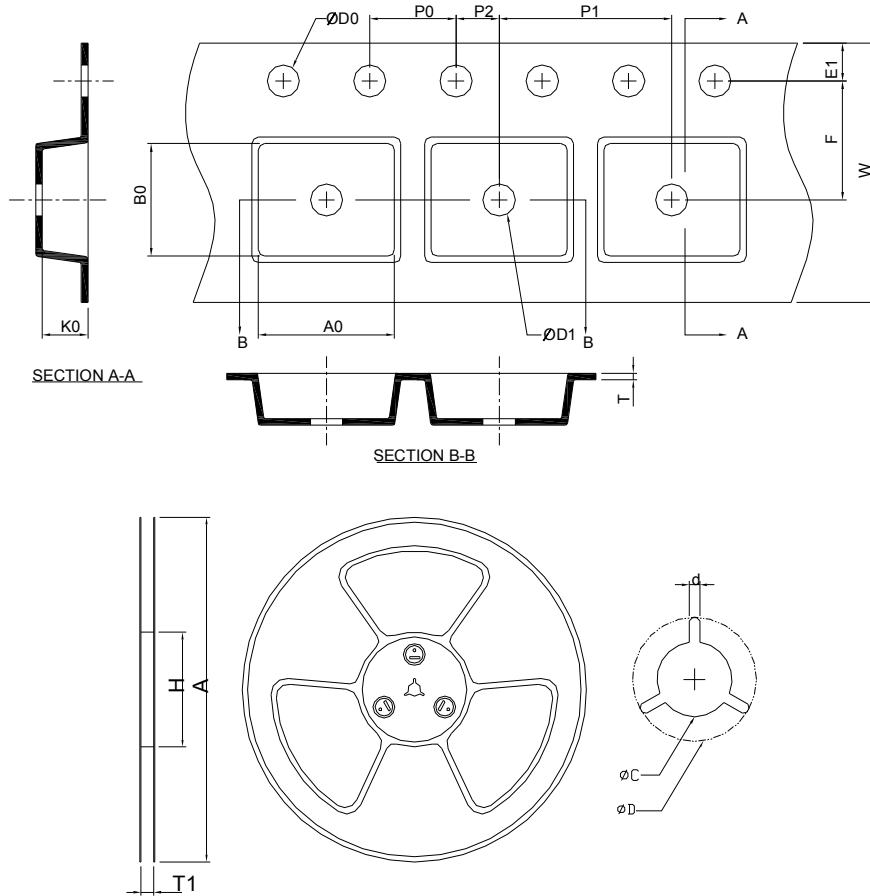

| Application | A | H | T1 | C | d | D | W | E1 | F |
|--------------------------|------------|-----------|--------------------|--------------------|-----------|-------------------|-----------|-----------|-----------|
| DFN3x3-8 (punch type) | 330.0±2.00 | 50 MIN. | 12.4+2.00 -0.00 | 13.0+0.50 -0.20 | 1.5 MIN. | 20.2 MIN. | 12.0±0.30 | 1.75±0.10 | 5.5±0.05 |
| | P0 | P1 | P2 | D0 | D1 | T | A0 | B0 | K0 |
| | 4.0±0.10 | 8.0±0.10 | 2.0±0.05 | 1.5+0.10 -0.00 | 1.5 MIN. | 0.6+0.00 -0.40 | 3.35±0.20 | 3.35±0.20 | 1.30±0.20 |

(mm)

Taping Direction Information

DFN3x3-8

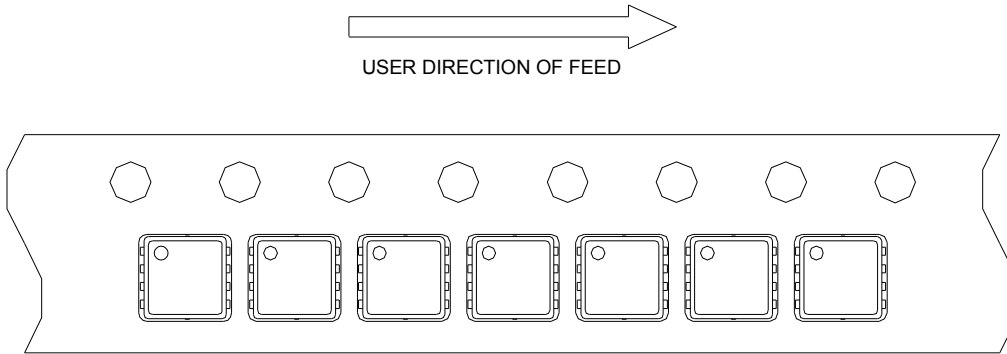

Classification Profile

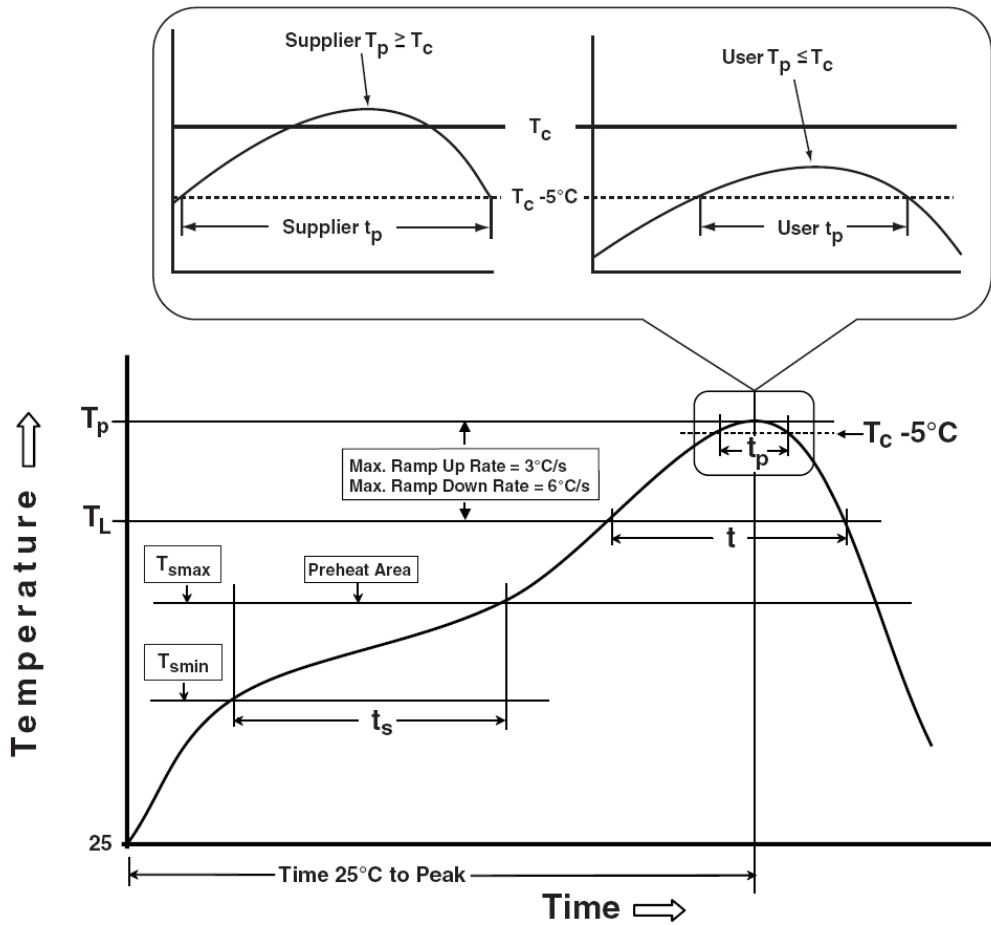

Classification Reflow Profiles

| Profile Feature | Sn-Pb Eutectic Assembly | Pb-Free Assembly |
|---|------------------------------------|------------------------------------|
| Preheat & Soak | | |
| Temperature min (T_{smin}) | 100 °C | 150 °C |
| Temperature max (T_{smax}) | 150 °C | 200 °C |
| Time (T_{smin} to T_{smax}) (t_s) | 60-120 seconds | 60-120 seconds |
| Average ramp-up rate (T_{smax} to T_p) | 3 °C/second max. | 3°C/second max. |
| Liquidous temperature (T_L) | 183 °C | 217 °C |
| Time at liquidous (t_L) | 60-150 seconds | 60-150 seconds |
| Peak package body Temperature (T_p)* | See Classification Temp in table 1 | See Classification Temp in table 2 |
| Time (t_p)** within 5°C of the specified classification temperature (T_c) | 20** seconds | 30** seconds |
| Average ramp-down rate (T_p to T_{smax}) | 6 °C/second max. | 6 °C/second max. |
| Time 25°C to peak temperature | 6 minutes max. | 8 minutes max. |
| * Tolerance for peak profile Temperature (T_p) is defined as a supplier minimum and a user maximum. ** Tolerance for time at peak profile temperature (t_p) is defined as a supplier minimum and a user maximum. | | |

Table 1. SnPb Eutectic Process – Classification Temperatures (T_c)

| Package Thickness | Volume mm ³ <350 | Volume mm ³ ≥350 |
|-------------------|-----------------------------|-----------------------------|
| <2.5 mm | 235 °C | 220 °C |
| ≥2.5 mm | 220 °C | 220 °C |

Table 2. Pb-free Process – Classification Temperatures (T_c)

| Package Thickness | Volume mm ³ <350 | Volume mm ³ 350-2000 | Volume mm ³ >2000 |
|-------------------|-----------------------------|---------------------------------|------------------------------|
| <1.6 mm | 260 °C | 260 °C | 260 °C |
| 1.6 mm – 2.5 mm | 260 °C | 250 °C | 245 °C |
| ≥2.5 mm | 250 °C | 245 °C | 245 °C |

Reliability Test Program

| Test item | Method | Description |
|---------------|---------------|--|
| SOLDERABILITY | JESD-22, B102 | 5 Sec, 245°C |
| HTRB | JESD-22, A108 | 1000 Hrs, 80% of VDS max @ T_{jmax} |
| HTGB | JESD-22, A108 | 1000 Hrs, 100% of VGS max @ T_{jmax} |
| PCT | JESD-22, A102 | 168 Hrs, 100%RH, 2atm, 121°C |
| TCT | JESD-22, A104 | 500 Cycles, -65°C~150°C |

Customer Service

Sinopower Semiconductor, Inc.

5F, No. 6, Dusing 1St Rd., Hsinchu Science Park,

Hsinchu, 30078, Taiwan

TEL: 886-3-5635818 Fax: 886-3-5642050