

## N-Channel Enhancement Mode MOSFET

### Features

- 75V/170A\*\*,  
 $R_{DS(ON)} = 4.3m\Omega(max.) @ V_{GS} = 10V$
- Reliable and Rugged
- Lead Free and Green Devices Available  
 (RoHS Compliant)

### Pin Description

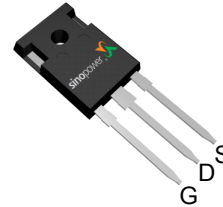

Top View of TO-247

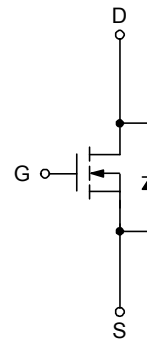

N-Channel MOSFET

### Applications

- Synchronous Rectification.
- Power Management in Inverter Systems.

### Ordering and Marking Information

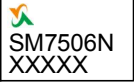
<p>SM7506NS</p> <p>□□-□□□</p> <p>└─ Assembly Material</p> <p>└─ Handling Code</p> <p>└─ Temperature Range</p> <p>└─ Package Code</p>	<p>Package Code W : TO-247</p> <p>Operating Junction Temperature Range C : -55 to 150 °C</p> <p>Handling Code TU : Tube (30ea/tube)</p> <p>Assembly Material G : Halogen and Lead Free Device</p>
<p>SM7506NS W :</p>	 <p>XXXXX - Lot Code</p>

Note: SINOPOWER lead-free products contain molding compounds/die attach materials and 100% matte tin plate termination finish; which are fully compliant with RoHS. SINOPOWER lead-free products meet or exceed the lead-free requirements of IPC/JEDEC J-STD-020D for MSL classification at lead-free peak reflow temperature. SINOPOWER defines "Green" to mean lead-free (RoHS compliant) and halogen free (Br or Cl does not exceed 900ppm by weight in homogeneous material and total of Br and Cl does not exceed 1500ppm by weight).

SINOPOWER reserves the right to make changes to improve reliability or manufacturability without notice, and advise customers to obtain the latest version of relevant information to verify before placing orders.

## Absolute Maximum Ratings

Symbol	Parameter	Rating	Unit
<b>Common Ratings</b> ( $T_A=25^\circ\text{C}$ Unless Otherwise Noted)			
$V_{DSS}$	Drain-Source Voltage	75	V
$V_{GSS}$	Gate-Source Voltage	$\pm 25$	
$T_J$	Maximum Junction Temperature	175	$^\circ\text{C}$
$T_{STG}$	Storage Temperature Range	-55 to 175	$^\circ\text{C}$
$I_S$	Diode Continuous Forward Current	$T_C=25^\circ\text{C}$ 80	A
<b>Mounted on Large Heat Sink</b>			
$I_{DP}$	300 $\mu\text{s}$ Pulse Drain Current Tested	$T_C=25^\circ\text{C}$ 480*	A
$I_D$	Continuous Drain Current(Silicon Limited)	$T_C=25^\circ\text{C}$ 170**	A
		$T_C=100^\circ\text{C}$ 130**	
$I_D$	Continuous Drain Current(Wire Bond Limited)	$T_C=25^\circ\text{C}$ 120	A
		$T_C=100^\circ\text{C}$ 120	
$P_D$	Maximum Power Dissipation	$T_C=25^\circ\text{C}$ 300	W
		$T_C=100^\circ\text{C}$ 150	
$R_{\theta JC}$	Thermal Resistance-Junction to Case	0.5	$^\circ\text{C/W}$
$R_{\theta JA}$	Thermal Resistance-Junction to Ambient	50	
$E_{AS}$	Avalanche Energy, Single Pulsed	$L=1\text{mH}$ 1.3	J

Note : \* Pulse width limited by safe operating area.

\*\* Calculated continuous current based on maximum allowable junction temperature. Bonding wire limitation current is 120A.

## Electrical Characteristics ( $T_A = 25^\circ\text{C}$ Unless Otherwise Noted)

Symbol	Parameter	Test Conditions	SM7506NSW			Unit
			Min.	Typ.	Max.	
<b>Static Characteristics</b>						
$BV_{DSS}$	Drain-Source Breakdown Voltage	$V_{GS}=0\text{V}, I_{DS}=250\mu\text{A}$	75	-	-	V
$\Delta BV_{DSS}/\Delta T_J$	Breakdown Voltage Temp. Coefficient	$V_{GS}=0\text{V}, I_{DS}=250\mu\text{A}$	-	0.07	-	$\text{V}/^\circ\text{C}$
$I_{DSS}$	Zero Gate Voltage Drain Current	$V_{DS}=60\text{V}, V_{GS}=0\text{V}$ $T_J=85^\circ\text{C}$	-	-	1	$\mu\text{A}$
			-	-	30	
$V_{GS(th)}$	Gate Threshold Voltage	$V_{DS}=V_{GS}, I_{DS}=250\mu\text{A}$	2	3	4	V
$I_{GSS}$	Gate Leakage Current	$V_{GS}=\pm 25\text{V}, V_{DS}=0\text{V}$	-	-	$\pm 100$	nA
$R_{DS(ON)}^a$	Drain-Source On-state Resistance	$V_{GS}=10\text{V}, I_{DS}=40\text{A}$	-	3.5	4.3	$\text{m}\Omega$

## Electrical Characteristics (Cont.) (T<sub>A</sub> = 25°C Unless Otherwise Noted)

Symbol	Parameter	Test Conditions	SM7506NSW			Unit
			Min.	Typ.	Max.	
<b>Diode Characteristics</b>						
V <sub>SD</sub> <sup>a</sup>	Diode Forward Voltage	I <sub>SD</sub> =20A, V <sub>GS</sub> =0V	-	0.8	1.1	V
t <sub>rr</sub>	Reverse Recovery Time	I <sub>DS</sub> =40A, dI <sub>SD</sub> /dt=100A/μs	-	75	-	ns
Q <sub>rr</sub>	Reverse Recovery Charge		-	160	-	nC
<b>Dynamic Characteristics<sup>b</sup></b>						
R <sub>G</sub>	Gate Resistance	V <sub>GS</sub> =0V, V <sub>DS</sub> =0V, F=1MHz	-	1.5	-	Ω
C <sub>iss</sub>	Input Capacitance	V <sub>GS</sub> =0V, V <sub>DS</sub> =30V, Frequency=1.0MHz	-	3200	4200	pF
C <sub>oss</sub>	Output Capacitance		-	1100	-	
C <sub>rss</sub>	Reverse Transfer Capacitance		-	450	-	
t <sub>d(ON)</sub>	Turn-on Delay Time	V <sub>DD</sub> =30V, R <sub>L</sub> =30Ω, I <sub>DS</sub> =1A, V <sub>GEN</sub> =10V, R <sub>G</sub> =6Ω	-	20	36	ns
T <sub>r</sub>	Turn-on Rise Time		-	25	45	
t <sub>d(OFF)</sub>	Turn-off Delay Time		-	72	130	
T <sub>f</sub>	Turn-off Fall Time		-	85	153	
<b>Gate Charge Characteristics<sup>b</sup></b>						
Q <sub>g</sub>	Total Gate Charge	V <sub>DS</sub> =30V, V <sub>GS</sub> =10V, I <sub>DS</sub> =40A	-	100	150	nC
Q <sub>gs</sub>	Gate-Source Charge		-	19	-	
Q <sub>gd</sub>	Gate-Drain Charge		-	30	-	

Note a : Pulse test ; pulse width ≤ 300μs, duty cycle ≤ 2%.

Note b : Guaranteed by design, not subject to production testing.

## Typical Operating Characteristics

Power Dissipation

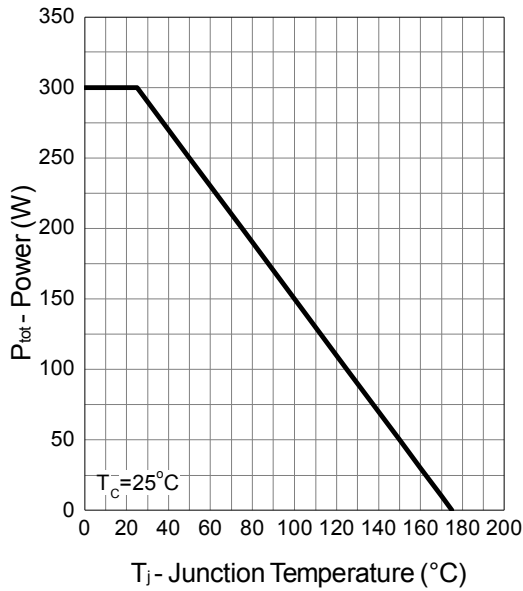

Drain Current

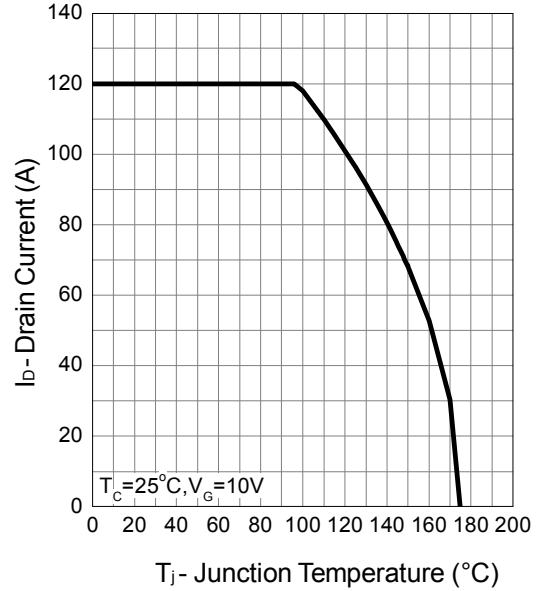

Safe Operation Area

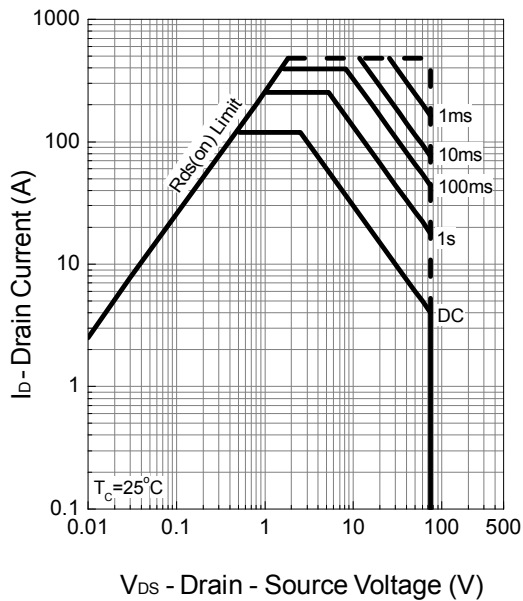

Thermal Transient Impedance

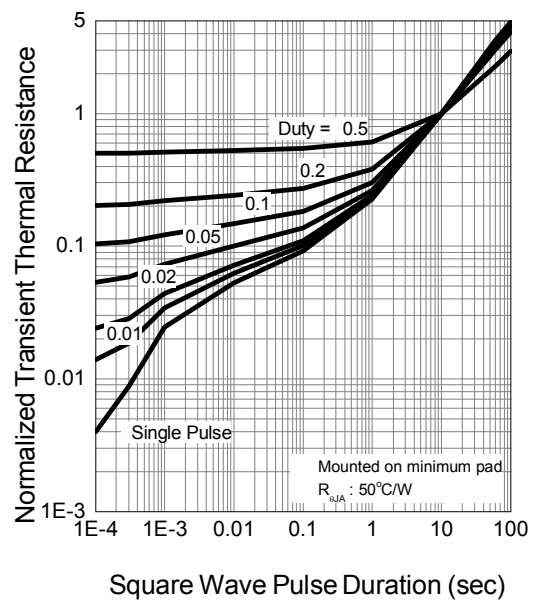

Typical Operating Characteristics (Cont.)

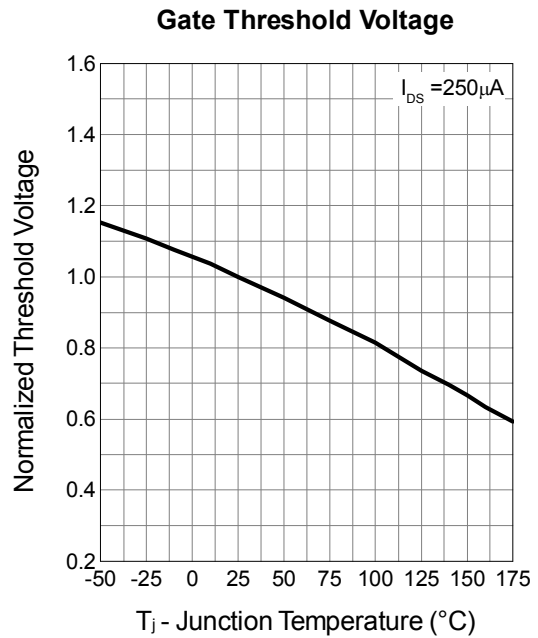
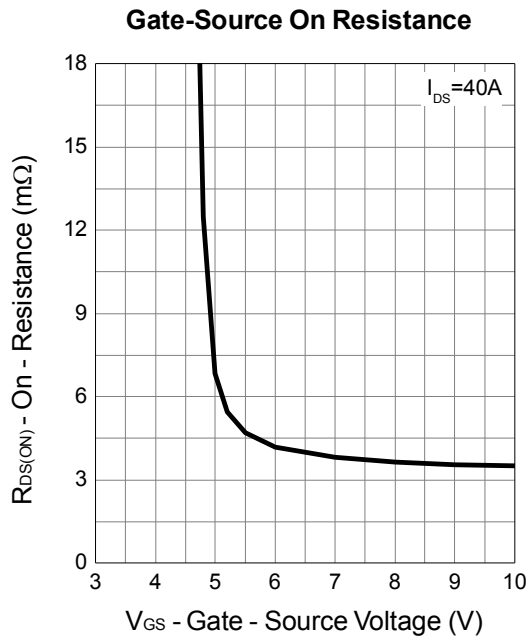
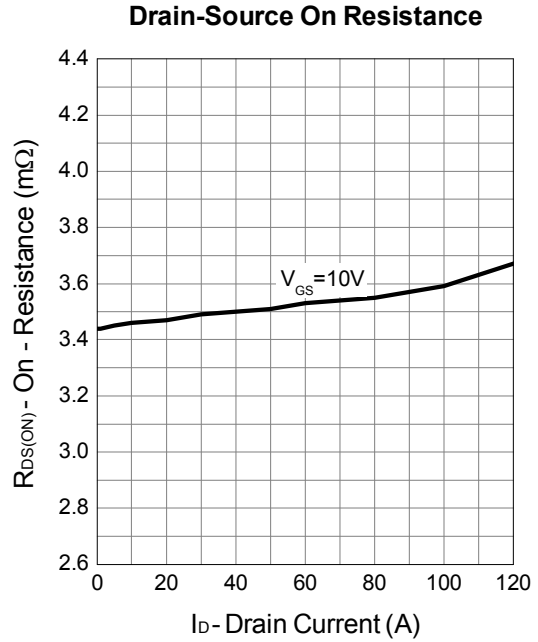
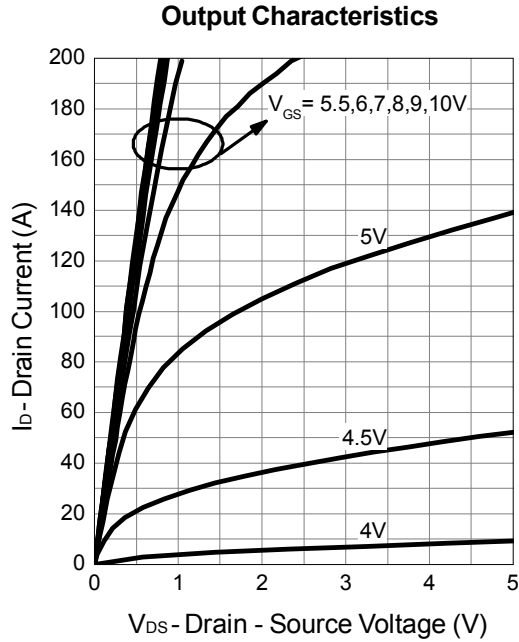

Typical Operating Characteristics (Cont.)

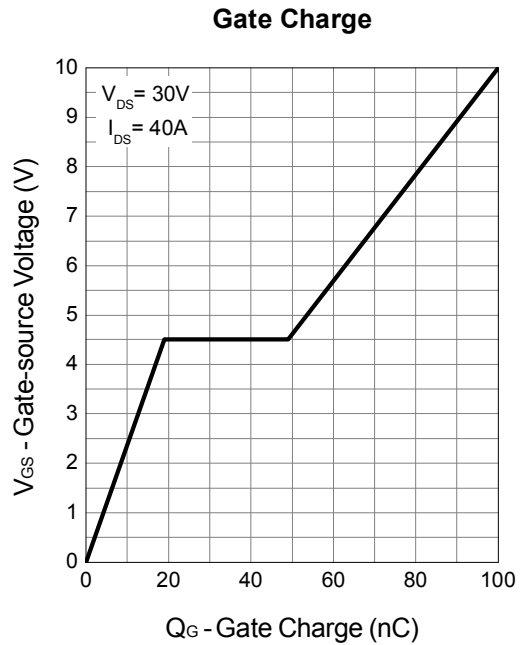
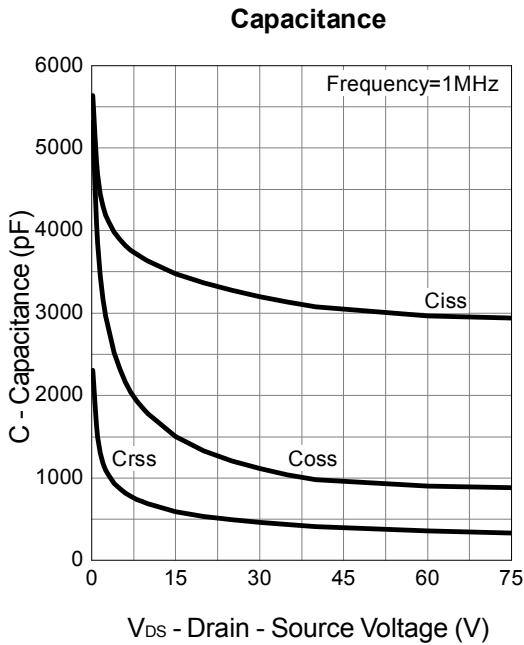
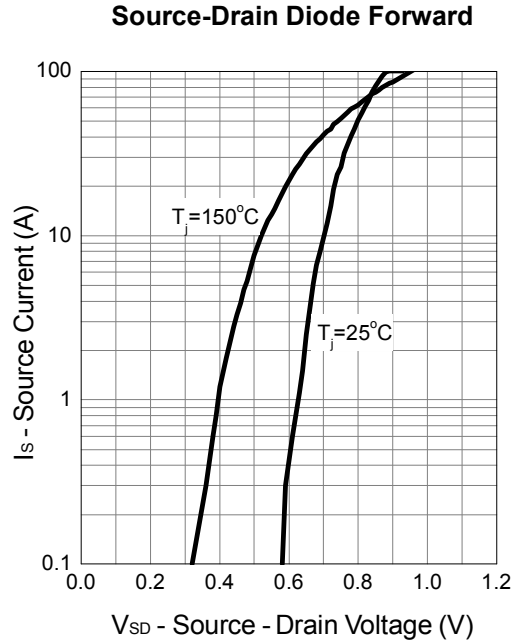
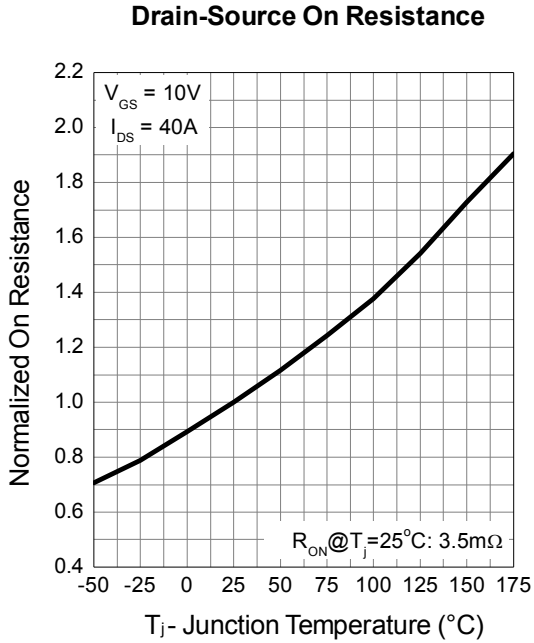

### Avalanche Test Circuit and Waveforms

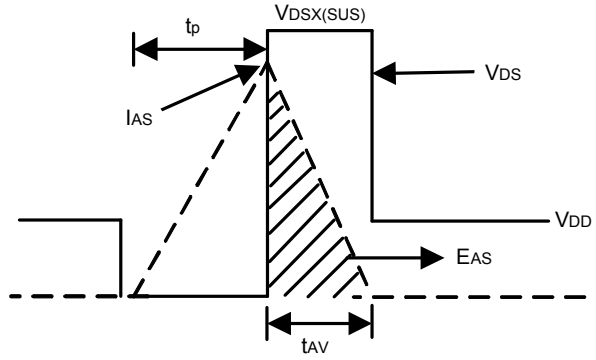
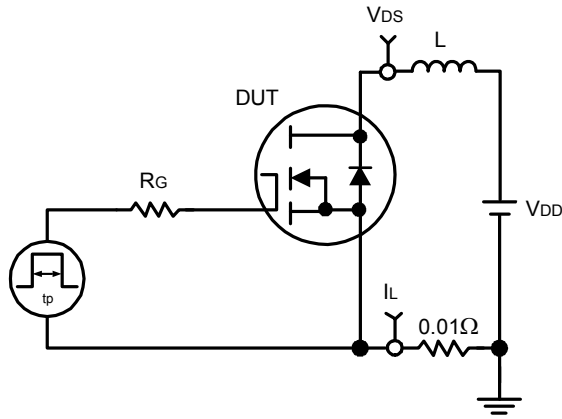

### Switching Time Test Circuit and Waveforms

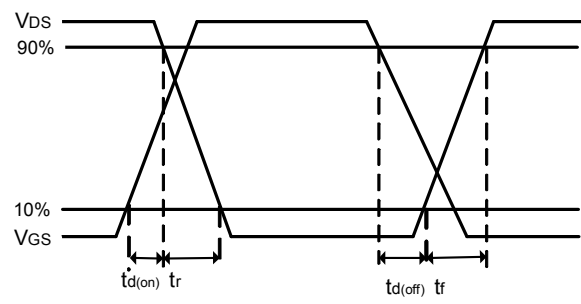
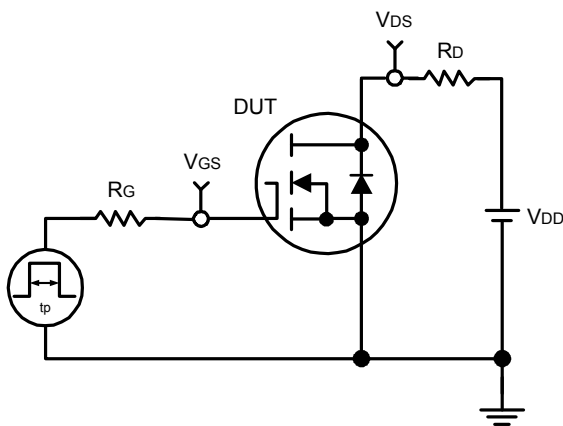

## Package Information

TO-247

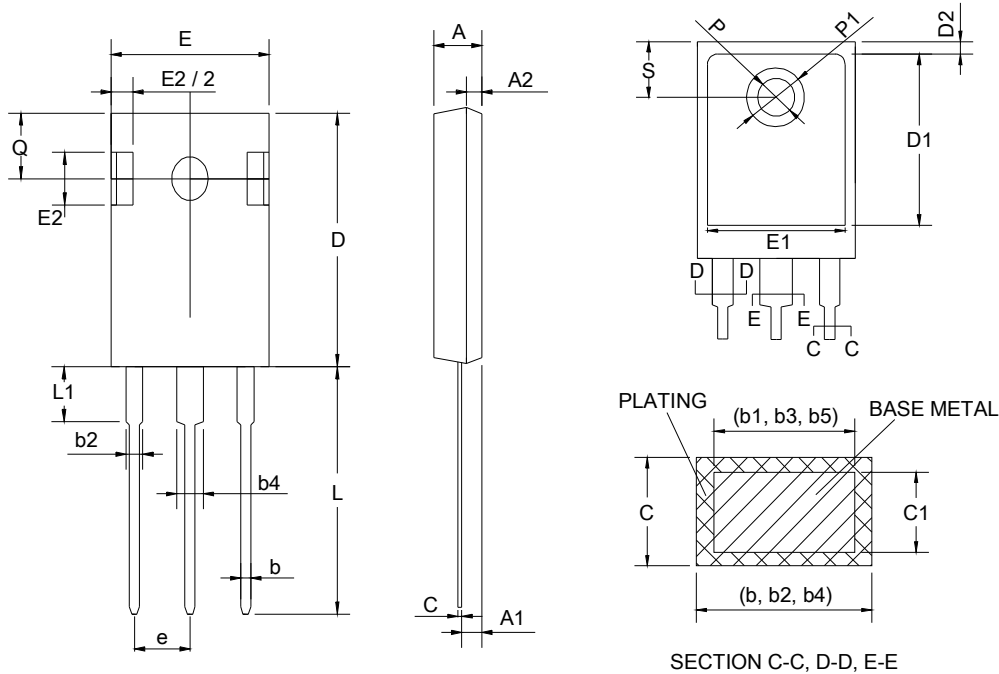

SECTION C-C, D-D, E-E

DIMENSIONS	TO-247			
	MILLIMETERS		INCHES	
	MIN.	MAX.	MIN.	MAX.
A	4.7	5.31	0.185	0.209
A1	2.21	2.59	0.087	0.102
A2	1.5	2.49	0.059	0.098
D	20.8	21.46	0.819	0.845
E	15.49	16.26	0.610	0.640
E2	4.32	5.49	0.170	0.216
e	5.46 BSC		0.215 BSC	
L	19.81	20.32	0.780	0.800
L1	-	4.5	-	0.177
P	3.56	3.66	0.140	0.144
Q	5.38	6.2	0.212	0.244
S	6.15 BSC		0.242 BSC	
b	0.99	1.4	0.039	0.055
b1	0.99	1.35	0.039	0.053
b2	1.65	2.39	0.065	0.094
b3	1.65	2.34	0.065	0.092
b4	2.59	3.43	0.102	0.135
b5	2.59	3.38	0.102	0.133
c	0.38	0.89	0.015	0.035
c1	0.38	0.84	0.015	0.033
D1	13.08	-	0.515	-
D2	0.51	1.35	0.020	0.053
E1	13.46	-	0.530	-
P1	-	7.4	-	0.291

### RECOMMENDED LAND PATTERN

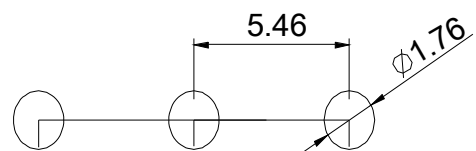

UNIT: mm



Classification Profile

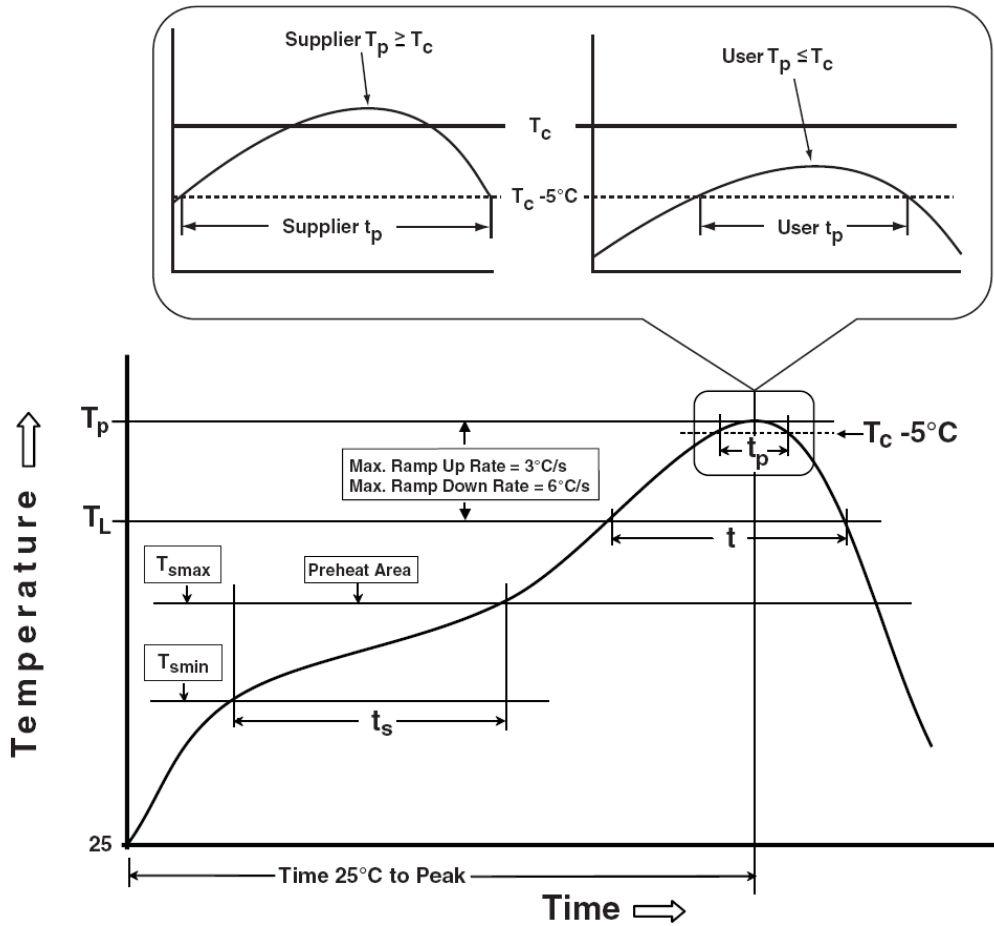

## Classification Reflow Profiles

Profile Feature	Sn-Pb Eutectic Assembly	Pb-Free Assembly
<b>Preheat &amp; Soak</b>		
Temperature min ( $T_{smin}$ )	100 °C	150 °C
Temperature max ( $T_{smax}$ )	150 °C	200 °C
Time ( $T_{smin}$ to $T_{smax}$ ) ( $t_s$ )	60-120 seconds	60-120 seconds
Average ramp-up rate ( $T_{smax}$ to $T_p$ )	3 °C/second max.	3°C/second max.
Liquidous temperature ( $T_L$ )	183 °C	217 °C
Time at liquidous ( $t_L$ )	60-150 seconds	60-150 seconds
Peak package body Temperature ( $T_p$ )*	See Classification Temp in table 1	See Classification Temp in table 2
Time ( $t_p$ )** within 5°C of the specified classification temperature ( $T_c$ )	20** seconds	30** seconds
Average ramp-down rate ( $T_p$ to $T_{smax}$ )	6 °C/second max.	6 °C/second max.
Time 25°C to peak temperature	6 minutes max.	8 minutes max.
* Tolerance for peak profile Temperature ( $T_p$ ) is defined as a supplier minimum and a user maximum.		
** Tolerance for time at peak profile temperature ( $t_p$ ) is defined as a supplier minimum and a user maximum.		

Table 1. SnPb Eutectic Process – Classification Temperatures ( $T_c$ )

Package Thickness	Volume mm <sup>3</sup> <350	Volume mm <sup>3</sup> ≥350
<2.5 mm	235 °C	220 °C
≥2.5 mm	220 °C	220 °C

Table 2. Pb-free Process – Classification Temperatures ( $T_c$ )

Package Thickness	Volume mm <sup>3</sup> <350	Volume mm <sup>3</sup> 350-2000	Volume mm <sup>3</sup> >2000
<1.6 mm	260 °C	260 °C	260 °C
1.6 mm – 2.5 mm	260 °C	250 °C	245 °C
≥2.5 mm	250 °C	245 °C	245 °C

## Reliability Test Program

Test item	Method	Description
SOLDERABILITY	JESD-22, B102	5 Sec, 245°C
HTRB	JESD-22, A108	1000 Hrs, 80% of VDS max @ $T_{jmax}$
HTGB	JESD-22, A108	1000 Hrs, 100% of VGS max @ $T_{jmax}$
PCT	JESD-22, A102	168 Hrs, 100%RH, 2atm, 121°C
TCT	JESD-22, A104	500 Cycles, -65°C~150°C

## Customer Service

### Sinopower Semiconductor, Inc.

5F, No. 6, Dusing 1St Rd., Hsinchu Science Park,

Hsinchu, 30078, Taiwan

TEL: 886-3-5635818 Fax: 886-3-5642050